

After reading this guide, keep it handy for future reference.



## User's Guide

### Hitachi Inverter

Communication Option for the PROFINET

P1-PN

Fundamental	S	Introduction · Cautions
	C	Table of Contents
	1	Safety Precautions
	2	Overview
	3	Preparing for Operation
	4	About the P1-PN
Required	5	Enclosed Items
	6	Installing and Connecting
	7	Parameter Settings
	8	About PROFINET
Verification	9	About PROFIdrive
	10	PNU (Parameter number)
	11	FAQ and Troubleshooting
Ref	12	Specifications
	13	Parameter List
	Appendix 1	Revision History

## S.1 Introduction

Thank you for purchasing the P1-PN: communication option for Hitachi SJ series P1 (afterward, “Hitachi SJ series P1” referred as SJ-P1).

This user's guide describes how to handle and maintain the P1-PN. Please read this guide carefully before using the P1-PN, and keep it handy for those who operate, maintain and inspect it.

For the purpose of reducing paper consumption and provision of the latest information, we enclose the Basic Guide only, while providing the User's Guide for more detailed description through electronic data instead of CD or printed document.

### ■About the User's Guide(this document)

The User's Guide provides detailed information necessary for handling the product. Please make sure to read this Guide for proper use.

If future updated descriptions differ from the Basic Guide, the description in the User's Guide will have higher priority. Always use the P1-PN strictly within the range described in the User's Guide and perform proper inspection and maintenance to prevent failures or accidents.

The latest version of the User's guide can be obtained through our website. In case it is not available or cannot be downloaded please contact the nearest sales office.

### ■About the Basic Guide

The Basic Guide provides the minimum information necessary for handling the product. Please make sure to read the Basic Guide as well as the User's Guide for more detailed information.

### ■Handling the inverter

For handling the inverter, please make sure to read its Basic Guide and User's Guide.

## S.2 Cautions

### ■For a proper use

Before using the inverter, please read carefully the inverter's Basic and User's Guide, the P1-PN Basic Guide and this guide.

In Addition any personnel who handles or performs maintenance to the product must read carefully the inverter's Basic and User's Guide, the P1-PN Basic Guide and this guide.

Before any attempt to install, operate, maintain or inspect this equipment, a complete understanding of the equipment specifications, safety instructions, precautions, handling and operation instructions is required. Additionally, periodically review the inverter's Basic and User's Guide, the P1-PN User's Guide and this guide.

### ■Precautions

It is prohibited to reproduce or reform this document partially or totally in any form without the publisher's permission.

The contents of the document are subject to change without prior notice.

If a hard copy of this document is required please contact the nearest sales office. Keep in mind that you will be charged for a hard copy of this document.

Any handling, maintenance or operation method NOT described on the inverter's Basic and User's Guide, the P1-PN Basic Guide or this guide is not covered by the product warranty. Please DO NOT perform any procedure NOT described on the SJ-P1 or the P1-PN guides since it can be the cause of unexpected failures or accidents.

We are not responsible for any impact from operations regardless of unexpected failure or accident due to operation or handling of the product in a manner not specified on the inverter's Basic and User's Guide, the P1-PN Basic Guide or this guide. We appreciate your understanding.

If you find any unclear or incorrect description, missing description or misplaced or missing pages, Please inform the Hitachi inverter technical service office.

Note that, in case the inverter's Basic and User's Guide, the P1-PN Basic Guide or this guide are enclosed, they should be delivered to the end user of the inverter. Also make sure to download and keep accessible any other related guides or instructions for the end user.

## S.3 Product Warranty and Inquiry

### ■ About product inquiry

- For an inquiry about product damage or faults or a question about the product, notify your supplier or Hitachi inverter technical service office.

When contacting the technical service, please provide the following information.

- Model: P1-PN
- Manufacture Number (MFG No.) :It shows on the name plate.  
(Please refer to the chapter 4, for more information)
- Date of Purchase: Purchase date by the customer
- Inquiry contents
  - Inform us the defective point and its condition.
  - Inform us the suspicious content and its details.

### ■ Product warranty

- The product P1-PN will be warranted by Hitachi Industrial Equipment Systems Co., Ltd.(afterwards referred as “Hitachi” ) during the warranty period from your date of purchase only under proper usage of product.
- However, the warranty expressed here is covered only for products delivered from Hitachi, and will not be responsible for others damage or loss of products like a motor or any equipment or systems damage caused by improper usage of the product. We recommend applying safety design which is able to provide a hazard notice to the user in case of malfunction or damage of the delivered product to minimize the consequences on other equipment or system. We advise that the selection of the delivered product is done with sufficient margin for performance, as well as using redundant design for other equipment or systems. Also, the compatibility of the product with the customer's intended use is not warranted, hence the customer has the responsibility to perform validation tests before any operation.
- In case a defective product is delivered, or quality failure during the manufacturing process are detected,, Hitachi will repair or exchange the product free of charge, only during the product warranty period (afterward, referred as “warranty service” ).
- After a warranty service, the exchanged or repaired part will be warranted for 6 months from the date of the warranty service. Hitachi will be responsible for repairing or exchanging the previously exchanged or repaired part only during this warranty period.

- Please verify that the inverter settings are adequate for operation, before operating it remotely through the network.
- In order to receive warranty service, you should present the receipt issued by the product supplier or any other document that allow us to check the purchase date. However, any defects, damage, malfunction or any other failure caused by one of the following facts will not be covered by warranty service.

- (1) Cannot confirm the purchase date.
- (2) The damage or fault resulted from improper usage or inadequate handling of the product or usage that does not comply with the instructions described in the user's guide or basic guide.
- (3) Incorrect usage of the product and/or the inverter, inadequate setting of the product and/or the inverter, remodeling or inadequate repair or repair carried out by an unqualified repair center.
- (4) Deterioration and wear as result of normal operation.
- (5) Fault resulted from natural disaster, such as earthquake, fire disaster, lightning strike, pollution, salt pollution, or abnormal voltage or any others external factors.
- (6) Shock, falling, or Vibration resulted during transportation or displacement after purchase.
- (7) Damage or fault resulted from remodeling firmware by unqualified personal not belonging to Hitachi.
- (8) Damage or fault resulted from using a function program (EzSQ).

### ■ Liability limitation

- In this product warranty, all warranties offered to the customer are stipulated, and neither Hitachi, affiliated companies or related dealers are liable to any express warranties or implied warranties including, but not limited to, product merchantability or specific application fitness.
- Also, Hitachi, affiliated companies or related dealers are not responsible of any incidental damage, special damage, direct loss, or indirect loss (even predictable or not) sustained by the customer as a result of a faulty product.

### ■ Using the warranty service

- The customer is able to receive a warranty service during the warranty period from the product supplier or service station, if the product does not meet the specifications described in this guide or the basic guide. However, this guide will have priority in case of content mismatch between this and the basic guide.
- A fare-paying service can also be obtained by contacting your supplier, local Hitachi distributor or service station.

### ■ Change on product specifications

- Please be aware that the information described in Brochure, Basic Guide, User's Guide or Technical Document might be modified without notice.

### ■ Precautions for the product operation

- The product should be operated following the working conditions, handling methods and precautions described in User's Guide.
- Please verify that the inverter settings are adequate for operation, before operating it remotely through the network.
- Please verify that the Hitachi inverter is correctly configured and installed for the intended purpose in the designed system.
- When using the Hitachi inverter please implement the following actions.
  - (1) Select an inverter with sufficient capacity for the rated current and performance.
  - (2) Implement safety design such as redundant system design.
  - (3) Implement safety design which minimizes risks in case of an inverter failure.
  - (4) Design the system in a way it can warn the operator about any danger.
  - (5) Carry out periodic maintenance to the customer's equipment as well as the inverter.
- For applications that involve human life, or have risk of an important loss, make sure to avoid a critical accident by installing a fail-safe device, protecting device, detecting device, alarm device, and/or spare device, etc.

### ■ Operation guarantee

- Even though the P1-PN complies with the PROFINET standard, we do not guarantee that it will operate properly with all types of master devices.

### ■ Security

- In the control system, recently, the connection and cooperation with the information communication system progress and security risks including cyber attacks are growing.

In a system applying this product, physical security measures mainly in the installation location and security measures in use via network are needed.

[Security risk example via the network]

- Abnormal operation, performance degradation, information leakage and data tampering by attacks from outside
  - Communication error and malfunction by overloading of a communication network
  - Malfunction, harm and damage occurrence due to programs and/or data tampering from outside
- The customer needs to make security measures, because the required security level in the control system is different depending on system.

In addition, for the maintenance of the security level will require continuous improvement measures, because the assumed security risk is not fixed and it will be something to change on a daily basis.

In a system using this product, regardless of the presence or absence of the use of security protection support functions, trouble, accident or damages caused by unauthorized external access, Hitachi Group will not be able to bear any responsibility.

It is required for the customer side to clarify the target of the security protection of the system, following the conduct measures example to a representative, please refer to the construction and operation of the system.

- Measures in the operational management, such as to lock the location of devices or limit the operator
- Update antivirus of network device to connect to the control system
- Utilize the security functions of the device configuring the network
- Monitoring the system and making a self-assessment for security periodically

■ Supplement

- This warranty term will not restrict the legal right of customer who has purchased the product.
- This warranty is valid only in Japan(excluding special types of contracts).
- Contact your sales agent for warranty of products purchased overseas.

## S.4 Getting Started

- Please follow the steps written below for start using the P1-PN.
- Before operating the device, please read and fully understand the safety precautions written below and on the Chapter 1.

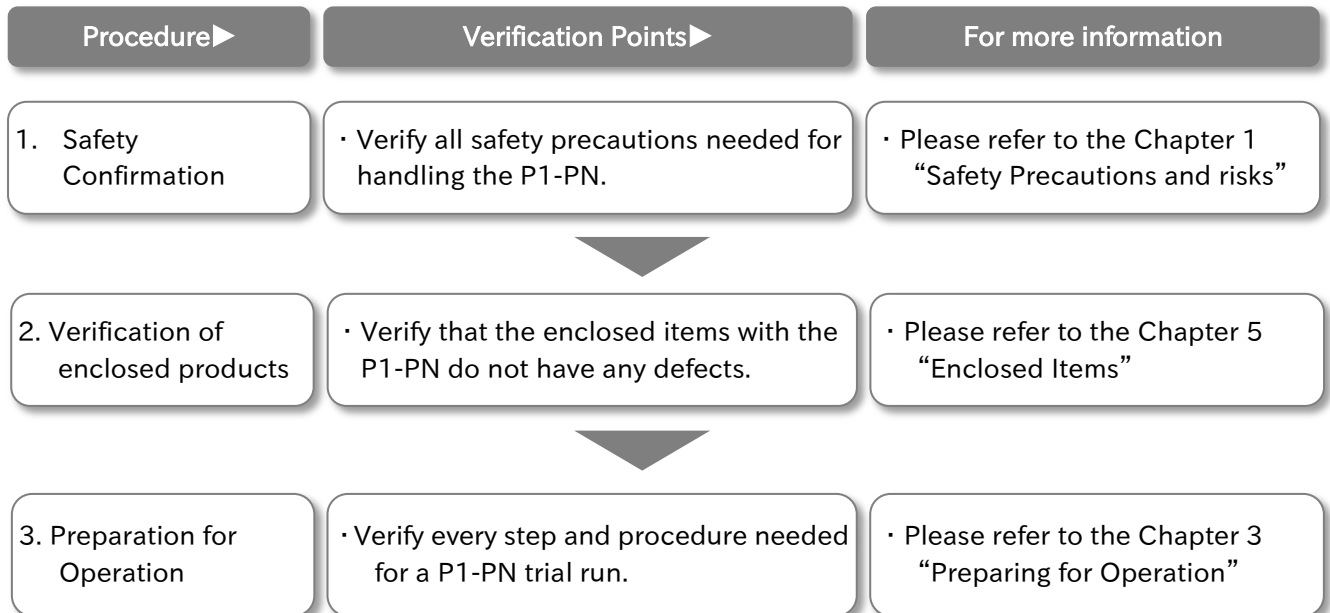

For more information, please refer to the following.

**About PROFINET ⇒ Chapter 8**

PROFINET will be explained.

**About PROFIdrive ⇒ Chapter 9**

PROFIdrive will be explained.

**PNU (Parameter number) ⇒ Chapter 10**

PNU will be explained.

**FAQ and Troubleshooting ⇒ Chapter 11**

Problems that may occur with the P1-PN and the inverter will be explained.

**In case the problem cannot be solved**

Contact your supplier or the Hitachi technical service.

## S.5 Related Documents

Document Name(Cassette Option)	Document Code
P1-PN (PROFINET Slave) User's Guide (this guide)	NT257X
P1-PN (PROFINET Slave) Basic Guide	NT2571X

Document Name (Inverter)	Document Code
SJ series P1 User's Guide	NT251*
SJ series P1 Basic Guide	NT2511*

The (\*) symbol on the Document Code column represents the version of the inverter guide.

## S.6 Registered Trademark

PROFINET® is trade names of the non-profit organization PROFIBUS Nutzerorganisation e.V.(PNO).

## C.1 Table of Contents

● Introduction · Cautions.....	S-1	● Table of Contents.....	C-1
● Product Warranty and Inquiry.....	S-2		

### Chapter 1 Safety Precautions

1.1 About this chapter.....	1-1	1.4 Precautions .....	1-3
1.2 Types of warnings.....	1-1	1.5 Caution label examples.....	1-7
1.3 Symbol explanation.....	1-2		

### Chapter 2 Overview

2.1 About this chapter.....	2-1	2.5 Guide outline .....	2-2
2.2 Applicable devices .....	2-1	2.6 Terminology .....	2-3
2.3 Before reading this guide .....	2-1	2.7 Symbol definition .....	2-3
2.4 Guide objectives.....	2-1		

### Chapter 3 Preparing for Operation

3.1 About this chapter.....	3-1	3.2 Preparation steps .....	3-2
-----------------------------	-----	-----------------------------	-----

### Chapter 4 About the P1-PN

4.1 About this chapter.....	4-1	4.3 Name plate.....	4-5
4.2 External features.....	4-2	4.4 Dimensions after installed .....	4-5

### Chapter 5 Enclosed Items

5.1 About this chapter.....	5-1	5.3 Verification after the purchase.....	5-3
5.2 About the enclosed items .....	5-2		

### Chapter 6 Installing and Connecting

6.1 About this chapter.....	6-1	6.4 Attach the ferrite cores.....	6-4
6.2 Supported inverters .....	6-2	6.5 About the connection.....	6-5
6.3 Installation.....	6-2		

### Chapter 7 Inverter Setting

7.1 About this chapter.....	7-1	7.2 Parameter settings .....	7-2
-----------------------------	-----	------------------------------	-----



## Chapter 8 About PROFINET

8.1 About this chapter.....	8-1	8.5 MAC address.....	8-3
8.2 GSDML File.....	8-2	8.6 LLDP.....	8-4
8.3 PROFINET.....	8-2	8.7 SNMP.....	8-8
8.4 Device Name (NameOfStation) and IP address.....	8-3	8.8 MRP.....	8-12

## Chapter 9 About PROFIdrive

9.1 About this chapter.....	9-1	9.7 Telegram.....	9-9
9.2 PROFIdrive.....	9-2	9.8 Parameter access.....	9-11
9.3 State machine on PROFIdrive.....	9-3	9.9 Fault.....	9-17
9.4 STW1 (Control word 1).....	9-5	9.10 Warning.....	9-18
9.5 ZSW1 (Status word 1).....	9-6	9.11 Operation example.....	9-19
9.6 NSOLL_A / NIST_A.....	9-8		

## Chapter 10 PNU (Parameter number)

10.1 About this chapter.....	10-1	10.5 PROFIdrive area.....	10-3
10.2 PNU (Parameter number).....	10-2	10.6 Device specific area (Inverter parameter area).....	10-9
10.3 Data types.....	10-2		
10.4 Access.....	10-2		

## Chapter 11 FAQ and Troubleshooting

11.1 About this chapter.....	11-1	11.3 P1-PN troubleshooting.....	11-3
11.2 Self-diagnosis.....	11-2	11.4 Inverter troubleshooting.....	11-7

## Chapter 12 Specifications

12.1 About this chapter.....	12-1	12.2 Device specifications.....	12-2
------------------------------	------	---------------------------------	------

## Chapter 13 Parameter List

13.1 About this chapter.....	13-1	13.2 Parameter list.....	13-2
------------------------------	------	--------------------------	------

## Appendix 1 Revision History

A1.1 About this chapter.....	A1-1	A1.2 Revision History.....	A1-2
------------------------------	------	----------------------------	------

# Chapter 1 Safety Precautions

## Contents

1.1 About this chapter.....	1-1
1.2 Types of warnings.....	1-1
1.3 Symbol explanation.....	1-2
1.4 Precautions .....	1-3
1.4.1 Please be careful!.....	1-3
1.4.2 Precautions during the installation! .....	1-3
1.4.3 Precautions during the wiring!.....	1-4
1.4.4 Precautions during operation and trial operation! .....	1-5
1.4.5 Precautions during Maintenance / Inspection!.....	1-5
1.4.6 Precautions for disposal! .....	1-6
1.4.7 Other Precautions.....	1-6
1.5 Caution labels examples .....	1-7

## 1.1 About this chapter

This chapter contains the information about Safety precautions during the installation, wiring, operation and inspection.

Before installation, wiring, operation, inspection, or usage please read completely and fully understand this guide.

## 1.2 Types of warnings

In this guide, the safety precautions as well as residual risks are categorized by degree of risk as “Danger” , “Warning” and “Caution” .

The definition of each category is described below.

### **Danger**

This category warns the user that in case of an incorrect or improper handling, it leads to a dangerous situation that have a high risk of causing death, serious injuries and/or major property damage.

### **Warning**

This category warns the user that in case of an incorrect or improper handling, it leads to a dangerous situation that may cause death, serious injuries and/or major property damage.

### **Caution**

This category warns the user that in case of an incorrect or improper handling, it leads to a dangerous situation that may cause physical injuries and/or property damage.







However, any content labeled with “ **Caution**” and depending on the case, might have a possibility of leading to a highly dangerous situation. It is extremely important that you follow the instructions and warnings.

Furthermore, content labeled with “ ” must be followed and paid special attention .

### 1.3 Symbol explanation

In this guide, there are some explanatory notes using different symbols. Please pay attention to this content and keep in mind its information.

#### Symbol definition

	<p>When handling this product, this symbol indicates danger, warning or caution about ignition, electric shock, high temperature or other dangers.</p> <p>Inside or near the  symbol, the specific content will be shown.</p>
	<p>This symbol indicates “General hazard not specified, be cautious” .</p>
	<p>This symbol indicates “Electric shock hazard” .</p>
	<p>This symbol indicates prohibited actions “Actions that should not be done” when handling this device.</p>
	<p>This symbol indicates actions that must be done based on the instructions.</p>

## 1.4 Precautions

### 1.4.1 Please be careful!



**Caution**

- If handled incorrectly or improperly, it might cause death, serious physical injuries, or damage to the inverter, motor or even the entire system.

**Do**

- Before installation, wiring, operation, inspection, or usage please read and fully understand this guide and other references.

**Caution**

- In order to explain this device details the illustrations in this guide might show this device without covers.

**Do**

- Before operating this device please return all the covers to the original position, and follow all the necessary regulations and instructions written in this guide.

**Caution**

- There will be additional warnings about hazards and failure causes in other chapters.

**Do**

- Before installation, wiring, operation, inspection, or usage please read and fully understand this guide.

### 1.4.2 Precautions during the installation!



**Risk of Fire!**

**Fire Hazard**

- DO NOT place inflammable objects nearby
- DO NOT let scraps of wire, welding sputtering, irons scraps or other objects get inside the device.

**Prohibited**

**Do**

- Avoid installing this device in places with high temperature, high humidity, Condensation-prone conditions, dusty conditions, corrosive gas, explosive gas, flammable gas, grinding fluid mist, hydrogen sulfide or salt damage prone conditions. Additionally, it is recommended to install this device in ventilated room not exposed to direct sunlight.

**Risk of an Inverter failure!**

**Failure**

- This device is a precision equipment, DO NOT drop it, or give it a strong shock.
- DO NOT get on (step on) or place heavy objects on this device.
- When handling the object, avoid places prone to static electricity(like carpets).

**Do**

- Since the human body can get charged with static electricity, as a safety measure please touch a safe metallic surface before handling this device.

**Risk of Injury!**

**Injury**

- DO NOT install or operate products with damage or missing parts.

**Prohibited**

## 1.4.3 Precautions during the wiring!

**Danger**Electric  
shock  
and Fire  
hazard

- **Risk of an electric shock and/or fire!**
  - Be sure to ground the inverter.
  - Entrust the wiring work only to a qualified electrician.
  - Before the wiring work make sure to turn off the power supply and wait for more than 10 or 15 minutes depending on the inverter model(\*). (Confirm that the charge lamp is OFF and the DC voltage between terminals P and N is 45 V or less)



Do

Electric  
shock  
and  
injury

- **Risk of an electric shock and/or injury!**

- Perform the wiring only after installing the inverter.



Do

\*) For P1-00044-L to P1-01240-L (P1-004L to P1-220L), P1-00041-H to P1-00620-H (P1-007H to P1-220H) models the wait time is 10 minutes.  
For P1-01530-L to P1-02950-L (P1-300L to P1-550L), P1-00770-H to P1-03160-H (P1-300H to P1-1320H) models the wait time is 15 minutes.



Failure

- **Risk of inverter failure!**

- DO NOT pull any wire after wiring.



Prohibited

**Warning**Electric  
shock  
and  
injury

- **Risk of an electric shock and/or injury!**
  - DO NOT operate/switch any of the switches from the 4 pole DIP switch on this device. When this device is shipped all switches are turned off.
  - If any of the switches from the 4 pole DIP switch is operated/switched, this device will not work as intended and it might be the cause of failure.
- **Do**
  - Please handle the cables properly and DO NOT let them get damaged. Using damaged cables will not only interfere with the correct operation of this device but also might be the cause of a system failure.



Do

Fire  
hazard

- **Risk of Fire!**

- Please tighten the screws and bolts with the specified torque.(Please refer to the inverter user's guide)
- Verify that none of the screws and bolts are loose.
- Make sure that the inverter and this device are fixed together with the securing screw.
- Make sure that the connectors are properly fixed.



Do

### 1.4.4 Precautions during operation and trial operation!

#### Danger



##### ● Risk of an electric shock or fire!

Electric shock and Fire hazard



Prohibited

- DO NOT touch the inside of this device, check the signal, do any wiring or plug/unplug the connectors while it energized.
- DO NOT insert any sick or rod like objects inside this device while it is energized.



Injury and Fire hazard



Prohibited

##### ● Risk of an injury and/or fire!

- DO NOT touch the inside of this device or the inverter while they are energized.



Electric shock



Prohibited

##### ● Risk of an electric shock!

- Make sure to fasten all the screws of this device before turning it on. DO NOT detach this device while it is energized or the inverter capacitors are still charged.
- Additionally DO NOT touch the inside of the inverter while the inverter capacitors are still charged.
- DO NOT touch this device with wet hands.

#### Warning



Injury or device Damage



Do

##### ● Risk of an injury and/or device damage!

- By using this device it becomes easier to change the settings and the output frequency of the inverter. When changing the settings or the output frequency of the inverter please make sure that it is within the supported range by the motor and/or the equipment.



Do

- In case this device is being used to make the inverter produce high frequency outputs for a motor or other equipment, make sure with the respective manufacturer that the motor or the equipment can tolerate the high frequency output given by the inverter.
- During operation verify the motor rotation direction, and that there are no irregular sounds or vibrations.

### 1.4.5 Precautions during Maintenance / Inspection!

#### Danger



Electric shock



Do

##### ● Risk of an electric shock!

- Before the wiring work make sure to turn off the power supply and wait for more than 10 or 15 minutes depending on the inverter model(\*). (Confirm that the charge lamp is OFF and the DC voltage between terminals P and N is 45 V or less)



Prohibited

- Entrust the maintenance, inspection and/or part replacement only to a specialized personnel. (Be sure to remove wristwatches and metal accessories, e.g., bracelets, before maintenance and inspection work and use insulated tools for the work).

\*) For P1-00044-L to P1-01240-L (P1-004L to P1-220L), P1-00041-H to P1-00620-H (P1-007H to P1-220H) models the wait time is 10 minutes.

For P1-01530-L to P1-02950-L (P1-300L to P1-550L), P1-00770-H to P1-03160-H (P1-300H to P1-1320H) models the wait time is 15 minutes.

## 1.4.6 Precautions for disposal!

**Danger**

Injury and  
explosion  
hazard

● Risk of an injury and/or an explosion!

- Outsource to a qualified industrial waste disposal contractor when discarding this device. Disposing of this device on your own may result in the production of poisonous gas
- Contact Hitachi technical service or your sales agent if you need to get this device fixed.

- A qualified waste disposer includes industrial waste collector/transporter and industrial waste disposal operator. Follow all laws and decrees related to procedures of waste management and public cleansing when disposing of this device.



Do

## 1.4.7 Other Precautions

**Danger**

Electric  
shock  
injury  
and Fire  
hazard

● Risk of an injury, an electric shock and/or fire!

- DO NOT modify this device.



Prohibited

※In addition to the precautions described above, there are other precautions described in the chapter 8 of the inverter user's guide. Please read and follow those precautions as well.

### 1.5 Caution labels examples

- We include the caution label templates for motor, inverter or system as related accidents or dangerous situations may be prevented. Please use these labels for your system or equipment.
- When the inverter is configured for remote operation, automatic operation or the retry function is active, there are cases when the operation will be resumed automatically after a shut down. In order to warn about this cases please use the label example on the right side as a reference.

(Label Template)

- Please fill in the label and use it for preventing accidents.



(Label example)

- For warning about automatically resumed operation after an error as a result of the retry function.

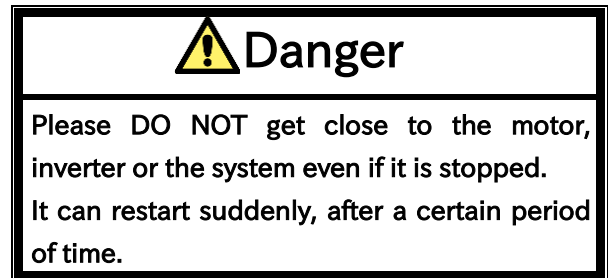

(Label example)

- For warning about remote or automatic operation after the system is powered on.

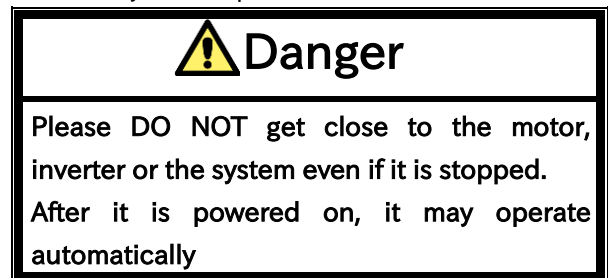



(Memo)

## 2

## Chapter 2 Overview

### Contents

2.1 About this chapter.....	2-1
2.2 Applicable devices .....	2-1
2.3 Before reading this guide .....	2-1
2.4 Guide objectives.....	2-1
2.5 Guide outline .....	2-2
2.6 Terminology .....	2-3
2.7 Symbol definition .....	2-3

### 2.1 About this chapter

This chapter specifies the devices that this guide will describe. Additionally, it contains information necessary to clearly understand this guide, the objectives of this guide and its terminology.

### 2.2 Applicable devices

The contents of this guide will apply to the P1-PN device. For information about the inverter please refer to the inverter's user's guide or the basic guide.

### 2.3 Before reading this guide

This guide is aimed for people who purchase, handle, install or connect control equipment, design systems or manage factories.

This guide units are based on the SI system.

### 2.4 Guide objectives

The objectives of this guide are:

- explain how to wire and connect the device.
- explain how to set the necessary parameters.

## 2.5 Guide outline

This guide has the following structure.

- The Chapter 1 “Safety Precautions” , contains the safety instructions for installing, wiring, operating, maintaining and inspecting this device.
- The Chapter 2 “Overview” , contains information necessary to clearly understand this guide, the objectives of this guide and its terminology.
- The Chapter 3 “Preparing for Operation” , contains the instructions step by step for operating this device successfully.
- The Chapter 4 “About this Product” , contains the explanation about the product appearance and general features.
- The Chapter 5 “Enclosed Items” , contains information about the items enclosed with this device.
- The Chapter 6 “Installing and connecting” , contains information for installing the P1-PN on the inverter.
- The Chapter 7 “Parameter Settings” , contains the explanation of the inverter parameters that relate with the P1-PN.
- The Chapter 8 “About PROFINET” , contains the PROFINET explanation.
- The Chapter 9 “About PROFIdrive” , contains the PROFIdrive explanation.
- The Chapter 10 “PNU (Parameter number” , contains the explanation about the PNU (Parameter number).
- The Chapter 11 “FAQ and Troubleshooting” , contains the explanation of the P1-PN LEDs lighting patterns, the explanation of inverter error (trip) status and its trouble shooting.
- The Chapter 12 “Specifications” , contains the specifications of the P1-PN.
- The Chapter 13 “Parameters List” , contains the list of PNU and Sub-index of inverter parameter.

## 2.6 Terminology

※Alphabetical order

### D

Term	Description
DCP	Discovery and basic Configuration Protocol. This is a protocol of PROFINET.

### G

Term	Description
GSDML file	General Station Description Markup Language It is the XML file which contains the information of the PROFINETIO Devices.

### L

Term	Description
LLDP	Link Layer Discovery Protocol. This is a protocol to collect information from their neighbors. Standardized by IEEE 802.1AB.

### M

Term	Description
MFG No.	Manufacture number.
MRP	Media Redundancy Protocol. This is a protocol for network redundancy.

### P

Term	Description
PNU	Parameter number. It is the parameter of PROFIdrive. This data is identified with an index from 0 to 65535. Some have up to 255 sub-indexes.
PROFINET	It is one of the open networks for industrial use. Standardized by the IEC 61158 and 61784. This includes RT (Real Time Protocol) and IRT (Isochronous Real Time Protocol) for cyclic process data.
PROFIdrive	It is the profile used as a driver.

### S

Term	Description
SNMP	Simple Network Management Protocol. This is a protocol to manage network devices.
STW	Control word

### T



Term	Description
Telegram	Communication data

### Z

Term	Description
ZSW	Status word

## 2.7 Symbol definition

In this guide, there are some explanatory notes using the symbols shown in the table below. This table also contains the explanation of each symbol.

Symbol and its definition	Description
<p>Questions about a particular situation.</p> 	Simply describes some problematic or recurring situations. Hence, in cases when an occurring situation is similar to a situation described in this guide, it may be solved by using this guide information and the P1-PN functions.
<p>Solution/Answer</p> 	Describes the settings and operations required in order to solve a particular problem or situation.
<p>Precautions</p> 	Describes the points of caution when using an indicated function. This descriptions contain information such as, data overwrite risk, indispensable settings, non-operation risk and other probable dangers.

(Memo)

# Chapter 3

# Preparing for Operation

# 3

## Contents

3.1 About this chapter.....	3-1
3.2 Preparation steps .....	3-2
3.2.1 Step 1: Preparing the inverter .....	3-2
3.2.2 Step 2: Installing the P1-PN .....	3-2
3.2.3 Step 3: Parameter setting .....	3-2
3.2.4 Step 4: Communicate with PROFINET ..	3-2
3.2.5 Step 5: Operate the inverter.....	3-3
3.2.6 Troubleshooting .....	3-3

## 3.1 About this chapter

This chapter contains the instructions step by step for operating this device successfully.

This chapter will refer to others chapters for more detail explanation. Hence for installation, mounting, wiring, operation setting and function detailed explanation, refer to the indicated or corresponding chapter. Additionally, when doing any work or operation, always follow the safety instructions and cautions given in the chapter 1.

## 3.2 Preparation steps

### 3.2.1 Step 1: Preparing the inverter

Follow the steps written in the inverter user's guide in order to prepare the inverter for operation. Furthermore, configure the parameters related to the motor.

For more details refer to the inverter user's guide.

### 3.2.2 Step 2: Installing the P1-PN

Turn OFF the inverter (refer to 1.4.3 for safety precautions), then install the P1-PN.

For more information refer to the Chapter 6 "Installing, Wiring and Connecting" .

### 3.2.3 Step 3: Parameter setting

Configure the parameters related to the P1-PN. When the parameters shown below are configured, P1-PN must be turned off and on to enable the configuration.

- [oH-34] Setpoint telegram/Actual value telegram  
Gr. Selection
- [oJ-\*\*] Flexible command registration writing  
register \*, Gr.\*

The rest of the parameters can be configured without turning off and on P1-PN.

For more information refer to the Chapter 7 "Inverter Settings" .

### 3.2.4 Step 4: Communicate with PROFINET

Install the P1-PN GSDML file into the PROFINET IO controller Configuration tool. Then configure this tool so the PROFINET IO controller and the P1-PN can communicate through PROFINET.

For more information refer to the Chapter 8 "About PROFINET" .

### 3.2.5 Step 5: Operate the inverter

The inverter can be operated by changing STW1 and NSOLL\_A settings.

If the steps described above were followed correctly, ZSW1, NIST\_A, and the inverter frequency output will change as shown in the table below

For more information refer to the Chapter 9 “About PROFIdrive” .

#### ■ Parameter setting value and monitor values

(in case the Maximum frequency setting is 60.00 [Hz].)

STW1	NSOLL_A	ZSW1	NIST_A	Output Frequency [Hz]
0x0000	0	0x0240	0	0.00
0x0406	0	0x0231	0	0.00
0x0407	0	0x0233	0	0.00
0x047F	0	0x0237	0	0.00
0x047F	0x4000	0x0237	Accelerate from 0 to 0x4000	Forward accelerate until 60.00
0x047F	0x4000	0x0337	0x4000	Forward 60.00
0x047F	0	0x0237	Decelerate from 0x4000 to 0	Decelerate until 0.00
0x047F	0	0x0337	0	0.00
0x047F	0xC000	0x0237	Accelerate from 0 to 0xC000	Reverse accelerate until 60.00
0x047F	0xC000	0x0337	0xC000	Reverse 60.00
0x0400	0xC000	After it stops 0x0240	Decelerate from 0xC000 to 0	Decelerate until 0.00 then it stops the operation

### 3.2.6 Troubleshooting

#### I want to know more about PNU!

Refer to the chapter 10 “PNU (Parameter number)” .

#### The motor does not rotate!

#### The inverter is showing an error!

Refer to the chapter 11 “FAQ and Troubleshooting” .



(Memo)

## 4



# Chapter 4 About the P1-PN

## Contents

4.1 About this chapter.....	4-1
4.2 External features.....	4-2
4.2.1 P1-PN appearance and nomenclature .	4-2
4.2.2 LED .....	4-3
4.2.3 Port 1 / 2 .....	4-4
4.3 Name plate .....	4-5
4.4 Dimensions after installed.....	4-5

## 4.1 About this chapter

This chapter contains the explanation about this product external features and information on the name plate. It is recommended to check this chapter contents and verify the device after the purchase.

Symbol	Definition
	Questions about a particular situation.
	Solution/Answer
	Precautions

## 4.2 External features

### 4.2.1 P1-PN appearance and nomenclature



· I need to know the external features of the P1-PN.



· The P1-PN external view is shown below.

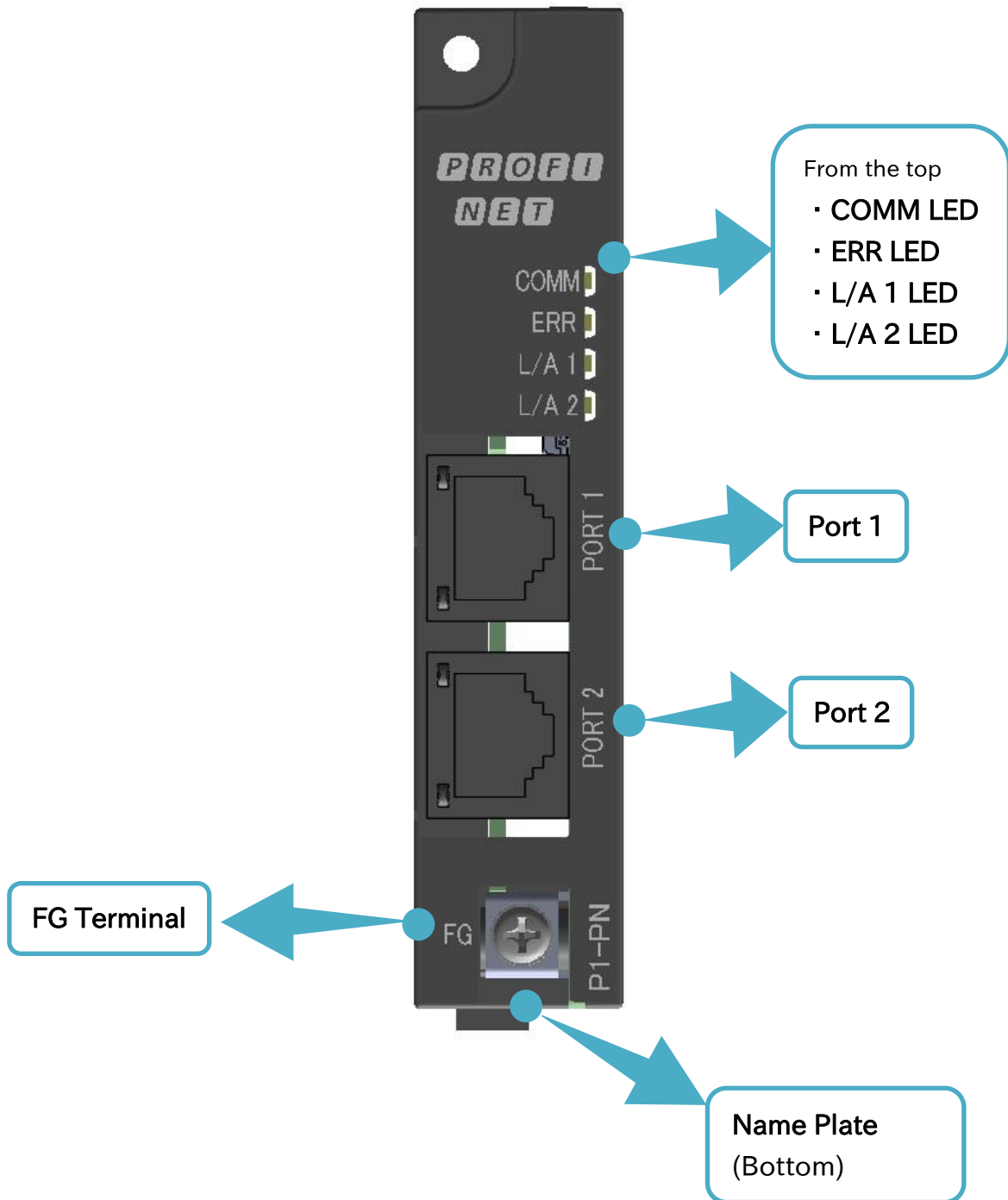

## 4.2.2 LED



· What do the LEDs show?



· The P1-PN LEDs are explained in the table below.

#### ■ LED definition

LED	Color	Lighting pattern	Description
COMM	Green	Light on	P1-PN is communicating with PROFINET IO controller by the set telegram.
		Blinking	P1-PN is already connected to PROFINET IO controller, but P1-PN doesn't communicate with PROFINET IO controller by the set telegram.
		Light off	P1-PN doesn't communicate with PROFINET IO controller by the set telegram.
ERR	Red	Light on	P1-PN detects hardware error or MAC address error.
		Blinking	P1-PN detects communication timeout.
		Light off	P1-PN doesn't detect any errors.
L/A 1 L/A 2	Green	Light on	Link established, but no transmission.
		Blinking	Link established, and transmitting.
		Light off	Link not established.

Blinking is 1 second switching on and 1 second switching off is repeated.

4.2.3 Port 1 / 2



· I need to know the connector specifications.



· The P1-PN connector specifications are shown below.

■ Connector Specifications

Connector Type	Notes
RJ-45	Its electric characteristics conform to the IEEE802.3 standard. It supports category 5e or higher.

■ Pin arrangement

Pin No	Notation	Signal Type
1	TD+	Transmit data +
2	TD-	Transmit data -
3	RD+	Receive data +
4	-	
5	-	
6	RD-	Receive data -
7	-	
8	-	

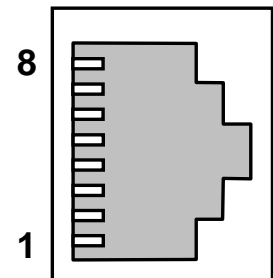

**Port 1 / 2**



· I want to know the necessary specifications for the communication cable.



· An Ethernet twist pair cable(category 5e or higher) is used for the connection. It is recommended to use a cable with the following specifications.

■ Cable recommended specifications

Item Name	Description
Twist pair cable	100BX-TX support (category 5e or higher) STP(Shield twist pair) cable (Straight or Crossed). The P1-PN supports the Auto MDI-X function which detects the cable connection type and configures the connection type accordingly.

### 4.3 Name plate



· What is the information written on the name plate?



· The image below The P1-PN name plate gives the following information.

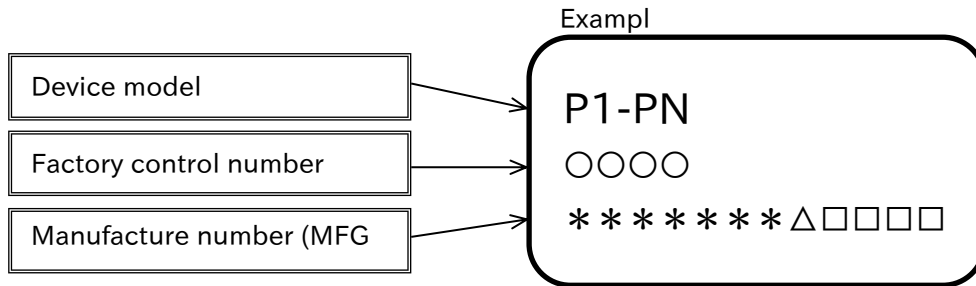

### 4.4 Dimensions after installed



· What are the P1-PN dimensions after being installed?



· As shown on the image a part of the P1-PN will stand out from the SJ-P1. Please be cautious when installing the device.



· The dimensions of the P1-PN after it is installed on the SJ-P1 are shown in the image below

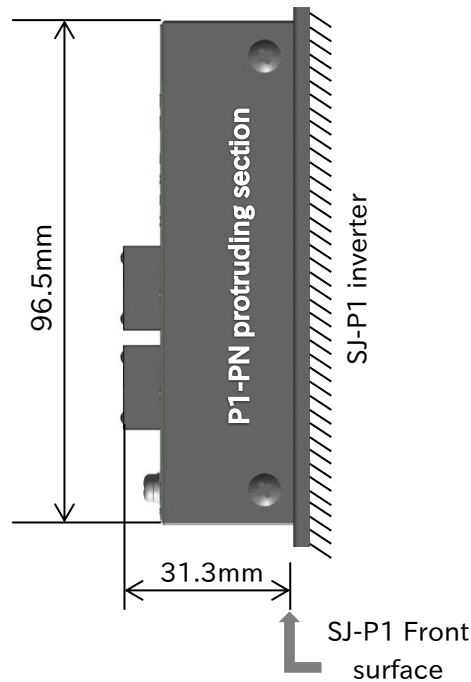

View from the right side of the SJ-P1

(Memo)

## 5



# Chapter 5 Enclosed Items

## Contents

5.1 About this chapter.....	5-1
5.2 About the enclosed items .....	5-2
5.3 Verification after the purchase .....	5-3
5.3.1 Verification when unpacking .....	5-3
5.3.2 Read this guide.....	5-3

## 5.1 About this chapter

This chapter contains information about the items enclosed with the P1-PN. Additionally, it is explained how to inspect and verify this product after its purchase.

Symbol	Definition
	Questions about a particular situation.
	Solution/Answer
	Precautions



## 5.2 About the enclosed items



· What items are enclosed?

· Enclosed items



· The enclosed items are shown on the images below.



P1-PN x1

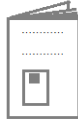

Basic Guide x1



Ferrite Core x2

### ■ Ferrite Core Specification

Item Name	Manufacturer	Model	Inner Diameter
Ferrite Core	SEIWA ELECTRIC MFG. Co., Ltd	E04SR200935A	9[mm]



Contact your sales agent immediately in case there are defects or imperfections.

## 5.3 Verification after the purchase





- What should I verify after the purchase?



### 5.3.1 Verification when unpacking

- Please verify the items written on the right when unpacking.
- In case there is any doubt or trouble with the product please contact your sales agent as soon as possible.

 Check that the items were not smashed or damaged during the delivery.

 Check that there is a P1-PN, there is a Basic Guide, there are 2 ferrite cores, when unpacking.

 Please check again that your order match with the name plate of the device.

### 5.3.2 Read this guide

- This guide contains the information necessary to handle the P1-PN correctly. Read it carefully and keep it safe.
- Also, use the inverter user's guide and basic guide as a reference.
- Please make sure that the P1-PN basic guide and the inverter basic guide reach the end user. Additionally, advice the end user to download and read the latest version of this guide.

(Memo)

## Chapter 6

Installing and  
Connecting

## 6

## Contents

6.1 About this chapter.....	6-1
6.2 Supported inverters .....	6-2
6.3 Installation .....	6-2
6.3.1 About the installation .....	6-2
6.3.2 How to install .....	6-3
6.4 Attach the ferrite cores.....	6-4
6.5 About the connection .....	6-5

6.1 About this chapter

This chapter contains information for installing the P1-PN on the inverter.

For information about the inverter installation please refer to the inverter user's guide.

Symbol	Definition
	Precautions

### 6.2 Supported inverters

The P1-PN can be attached to all types of SJ-P1. However, depending on the SJ-P1 manufacture date, it might not support the P1-PN. Please check the version of the inverter which is written on the name plate of it (the name plate example is shown on the image to the right). If the version is 2.00 or higher it can support the P1-PN.

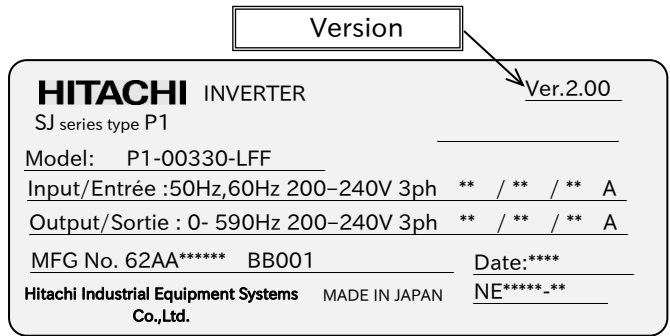

### 6.3 Installation

#### 6.3.1 About the installation

The P1-PN can be attached to any of the 3 option slots of the SJ-P1 inverter.

It can be attached to either SLOT1, 2 or 3.

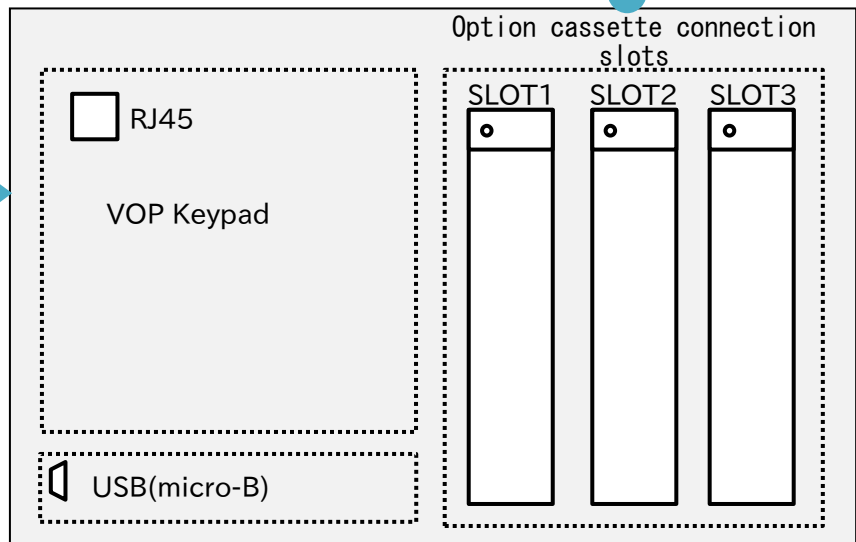
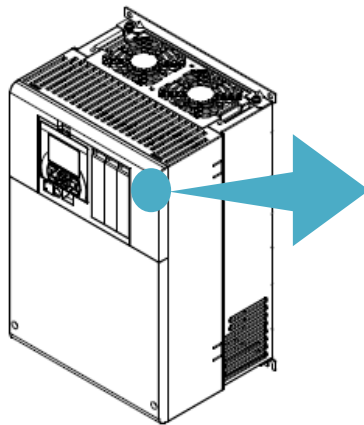

### 6.3.2 How to install

Before installing the P1-PN please refer to the chapter 7 “Inverter Setting” and configure the inverter.

For explanation purposes, it will be assumed that the P1-PN is going to be installed in the SLOT1.

- (1) Remove the cover of the option cassette connection slot. Despite the removed cover will no longer be needed, it is recommended to keep it in a safe place. However the screw that secured the cover will be used to secure the P1-PN.

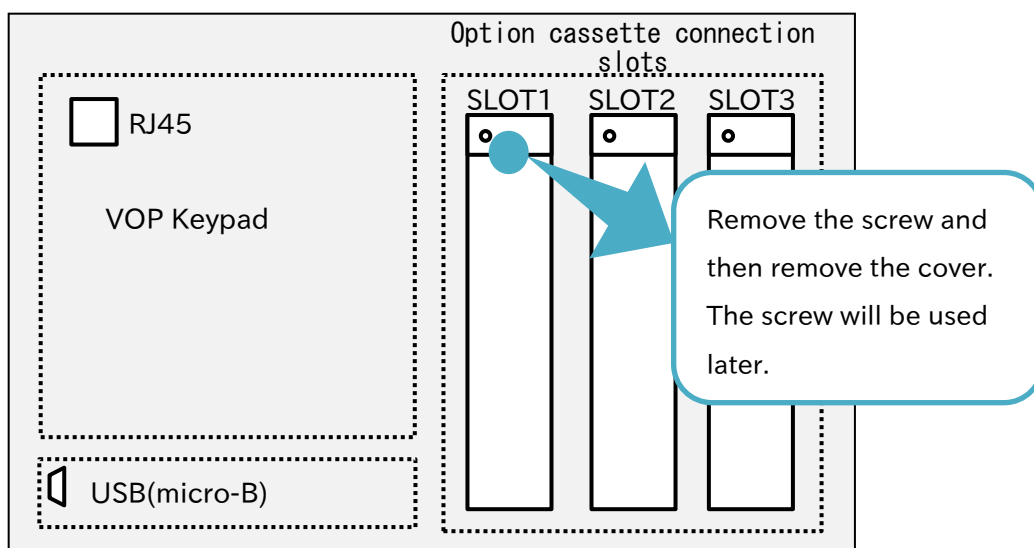

- (2) Attach the P1-PN. The slots 2 and 3 have one more connection in the lower side. However, the P1-PN will not need that connection.

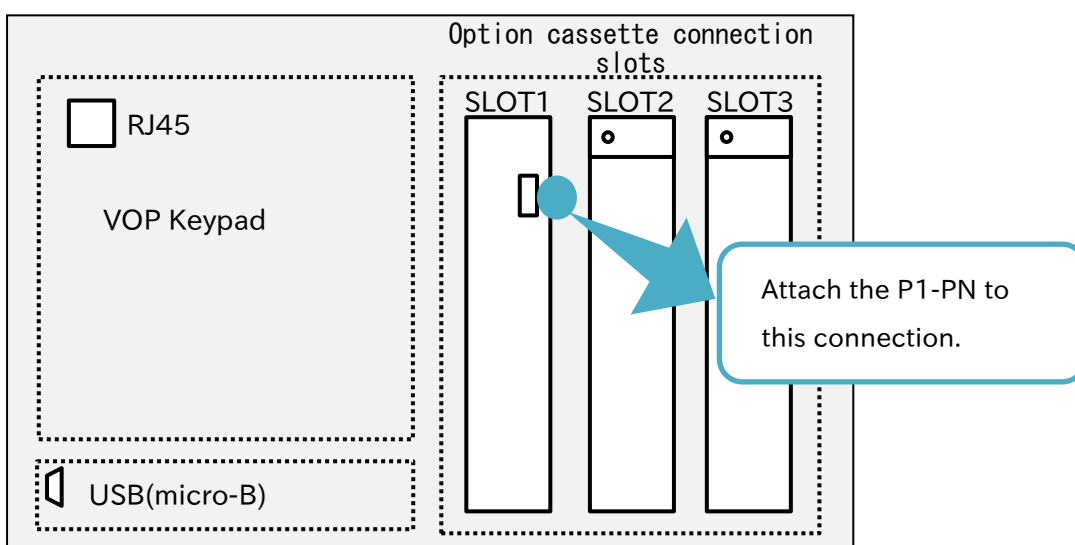

(3) Secure the P1-PN with the screw removed in procedure (1).

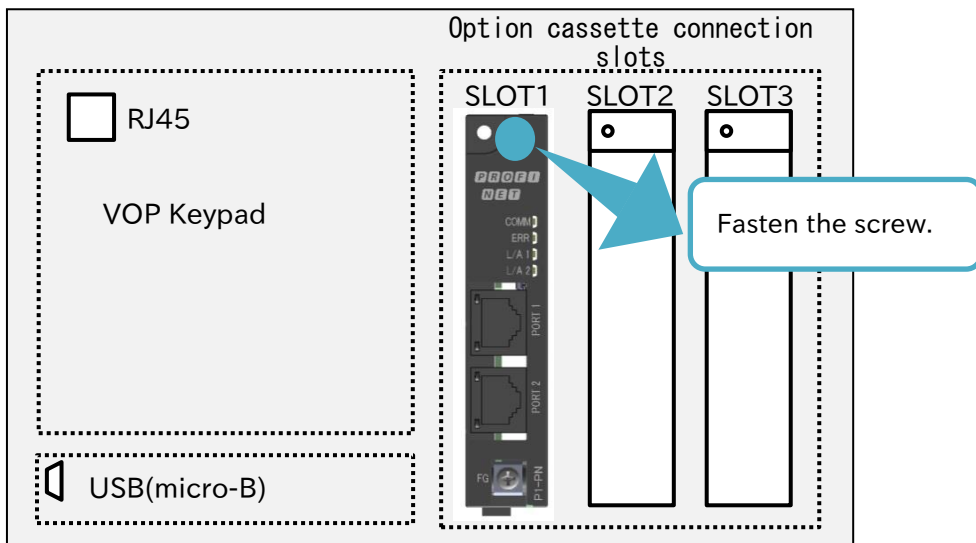

(4) Connect the FG terminal to functional ground.

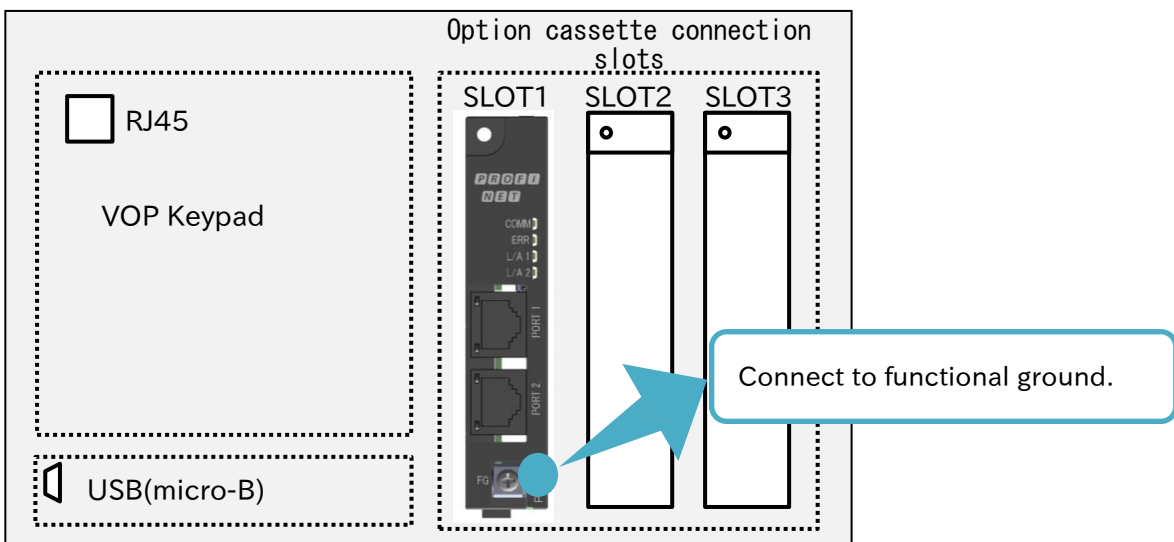

## 6.4 Attach the ferrite cores

Attach the included ferrite cores to the PROFINET cable. These cores should be attached as close as possible to the P1-PN RJ-45 connection.



Depending on the PROFINET cable the ferrite core cannot be correctly fixed to the cable and it may slip along the cable, despite having an anti-slip claw. In these cases the ferrite core can be fixed by attaching something like a clamping band or a wire to the PROFINET cable on one or both sides of the ferrite core. Keep in mind that the cores should be attached as close as possible to the P1-PN RJ-45 connection.

## 6.5 About the connection

- Make sure that the communication line and the power line are placed as far as possible from each other. If the power line and the communication line are placed close to each other, the communication line will pick up noise from the power line that can interfere with the transmission.
- Make sure to set up the system, so that in an event of a network failure, the inverter output stops immediately.
  - (1) In case the master detects an abnormality in the connection, shut down the inverter primary power supply.
  - (2) Allocate functions such as “free run” or “reset” to the input terminals, so when the master detects a connection abnormality it is capable of turning on these terminals.
  - (3) Configure the inverter so in case of a connection abnormality, it stops, free run stops or trip. (When the operation command is received through PROFINET, the inverter shipment settings are configured so that if there is any abnormality in the connection the inverter will immediately stop)



Connect the communication cable (Ethernet cable), so it minimizes the tension and stress over the connector.

For other information concerning the installation, please refer to the inverter user's guide.



(Memo)

## 7

# Chapter 7 Parameter Settings

## Contents

7.1 About this chapter.....	7-1
7.2 Parameter settings .....	7-2
7.2.1 Parameters that must be configured .....	7-2
7.2.2 Parameters that must be set as required by the application. ....	7-2
7.2.3 Parameters correlating the Inverter and the P1-PN.....	7-4
7.2.4 Other parameters .....	7-5

## 7.1 About this chapter

This chapter contains the information about the inverter settings that must be done when using the P1-PN.

Symbol	Definition
	Precautions

## 7.2 Parameter settings

This chapter explains how to configure the SJ-P1 inverter parameters in order to use the P1-PN.



- When [oH-34] and [oJ-\*\*] parameters are configured, P1-PN must be turned off and on to enable the configuration. The other parameters will be effective immediately after the change.

### 7.2.1 Parameters that must be configured



#### ■ List of parameters.

Item	Parameter No	Data	Description
Main speed input source selection, 1st motor	[AA101]	9 (Option-1) 10 (Option-2) 11 (Option-3)	Select the slot in which the P1-PN was installed.
Run-command input source selection, 1st motor	[AA111]	4 (Option-1) 5 (Option-2) 6 (Option-3)	

### 7.2.2 Parameters that must be set as required by the application.

#### ■ List of parameters.

Item	Parameter No	Data	Description	Caution
Deceleration time setting 2, 1st motor	[AC126]	0.00~ 3600.00(s)	Set the Quick stop deceleration time. This parameter setting is needed in case the Quick stop function is going to be used.	
Jogging frequency	[AG-20]	0.00~ 10.00(Hz)	Set the jogging frequency. This parameter setting is needed in case the Jogging function is going to be used.	
Jogging stop mode selection	[AG-21]	00~05	Set the jogging stop mode. This parameter setting is needed in case the Jogging function is going to be used. There is no difference between "Enable at run" and "Disable at run", because [JG] terminal becomes ON first. "00" and "03", "01" and "04", "02" and "05" are same action.	

Item	Parameter No	Data	Description	Caution
Arrival frequency setting during acceleration 1	[CE-10]	0.00~ 590.00(Hz)	Set the arrival frequency to turn on ZSW1 bit10 (f Or n Reached Or Exceeded / f Or n Not Reached) during acceleration. When 0.00(Hz) is set, this bit doesn' t turn on.	
Arrival frequency setting during deceleration 1	[CE-11]	0.00~ 590.00(Hz)	Set the arrival frequency to turn off ZSW1 bit10 during deceleration 1.	
Communication Watch Dog Timer	[oA-11] [oA-21] [oA-31]	0.00~ 100.00(s)	Set the communication watchdog timer of PROFINET. This watchdog timer is to monitor non communication after watchdog that is set by PROFINET configuration tool to the PROFINET master occurs. If 0.00(s) is set, P1-PN doesn' t monitor non communication.	
Action selection at communication error	[oA-12] [oA-22] [oA-32]	00~04	Set inverter action on communication error.	
Setpoint telegram/Actual value telegram Gr. Selection	[oH-34]	00~02	Set the group of Flexible command registration writing / reading register. Gr.A [oJ-01] ~ [oJ-10], [oJ-11] ~ [oJ-20] Gr.B [oJ-21] ~ [oJ-30], [oJ-31] ~ [oJ-40] Gr.C [oJ-41] ~ [oJ-50], [oJ-51] ~ [oJ-60]	
Flexible command registration writing register, Gr.A	[oJ-01] ~ [oJ-10]	0x0000~ 0xFFFF	Set the Modbus register number of parameters that P1-PN is received by Telegram 103, 104, and 105. Please refer to "9.6 Telegram" for details.	
Flexible command registration writing register, Gr.B	[oJ-21] ~ [oJ-30]			
Flexible command registration writing register, Gr.C	[oJ-41] ~ [oJ-50]			
Flexible command registration Reading register, Gr.A	[oJ-11] ~ [oJ-20]	0x0000~ 0xFFFF	Set the Modbus register number of parameters that P1-PN is sent by Telegram 103, 104, and 105. Please refer to "9.6 Telegram" for details.	
Flexible command registration Reading register, Gr.B	[oJ-31] ~ [oJ-40]			
Flexible command registration Reading register, Gr.C	[oJ-51] ~ [oJ-60]			

### 7.2.3 Parameters correlating the Inverter and the P1-PN

The parameters described in the following table control the action taken by the inverter when there is a problem with the P1-PN or when the P1-PN is connected.

#### Parameter

Code	Parameter name	Selection	Initial value
oA-10	Operation mode on option card error (SLOT-1)	00(Error)/ 01(Ignore error (Keep running))	00
oA-20	Operation mode on option card error (SLOT-2)	00(Error)/ 01(Ignore error (Keep running))	00
oA-30	Operation mode on option card error (SLOT-3)	00(Error)/ 01(Ignore error (Keep running))	00

- [oA-10]: Operation mode on option card error (SLOT-1)
- [oA-20]: Operation mode on option card error (SLOT-2)
- [oA-30]: Operation mode on option card error (SLOT-3)

These parameters can select whether to ignore the option error trip or not in cases where there are connection failures between the P1-PN and the inverter.

Let the inverter trip: 00 (error).

Ignore the error and continue with the operation: 01(Ignore error (Keep running)).

Please make sure to configure the parameter corresponding to the slot in which the P1-PN is attached.



In the event there is a communication failure between the inverter and the P1-PN, and the option 01 (Ignore error (Keep running)) is selected, the inverter operation will not stop. Additionally, in case there is a communication failure between the P1-PN and the inverter, the higher-level device (master) stop command will not be received. Thus, safety measures and precautions are recommended.

### 7.2.4 Other parameters

In addition to the configurations explained in sections 7.2.2 and 7.2.3, please verify the configuration of the following parameters when using the P1-PN.

- [CF-11]: Function for transforming the register data from A, V to %  
When using the P1-PN please select the 00(A, V) setting.
- [oA-13]: Run command selection at start up (SLOT-1)
- [oA-23]: Run command selection at start up (SLOT-2)
- [oA-33]: Run command selection at start up (SLOT-3)  
Please do not change these settings

(Memo)

## 8

# Chapter 8 About PROFINET

## Contents

8.1 About this chapter.....	8-1
8.2 GSDML File.....	8-2
8.3 PROFINET .....	8-2
8.4 Device Name (NameOfStation) and IP address .....	8-3
8.5 MAC address .....	8-3
8.6 LLDP .....	8-4
8.6.1 chassis ID.....	8-4
8.6.2 port ID .....	8-4
8.6.3 Time To Live .....	8-5
8.6.4 LLDP_PNIO_PORTSTATUS.....	8-5
8.6.5 LLDP_PNIO_CHASSIS_MAC.....	8-5
8.6.6 LLDP8023MACPHY .....	8-6
8.6.7 LLDPManagement.....	8-6
8.6.8 End .....	8-7
8.7 SNMP.....	8-8
8.7.1 MIB-2 .....	8-9
8.7.2 LLDP-MIB.....	8-10
8.7.3 LLDP-EXT-PNIO-MIB .....	8-11
8.7.4 LLDP-EXT-DOT3-MIB .....	8-12
8.8 MRP .....	8-12

## 8.1 About this chapter

This chapter contains a general explanation about PROFINET.



## 8.2 GSDML File

In order to use the P1-PN, it is necessary to install the P1-PN GSDML file into the PROFINET IO controller Configuration tool. The GSDML file is a text file that has the specific information of the PROFINET IO device.

The GSDML file can be obtained through our website. In case is not available or cannot be downloaded please contact the nearest sales office.

## 8.3 PROFINET

The P1-PN supports below function about PROFINET.

Item	Specification
PROFINET protocol	PROFINET IO Ver.2.33
Unit type	PROFINET IO device
Conformance class	B
Protocol	DCP (Discovery and basic Configuration Protocol) LLDP (Link Layer Discovery Protocol) SNMP (Simple Network Management Protocol) MRP (Media Redundancy Protocol)
Netload	I
RT / IRT	only RT
Profile	PROFIdrive
Device ID	0x0302
LLDP Support TLV	chassis ID port ID Time To Live LLDP_PNIO_PORTSTATUS LLDP_PNIO_CHASSIS_MAC LLDP8023MACPHY LLDPManagement End TLV
SNMP Support MIB	MIB-2 LLDP-MIB LLDP-EXT-PNIO-MIB LLDP-EXT-DOT3-MIB
Physical layer	Auto negotiation (100BASE-TX (IEEE802.3) only)
port	2 ports
MAC address	3 (Host, Port 1 / 2)

## 8.4 Device Name (NameOfStation) and IP address

You need to set device name (NameOfStation) and IP address to P1-PN with engineering tool.

Please refer to the manual of the engineering tool for the usage.

## 8.5 MAC address

P1-PN has 3 MAC addresses of host, port1, and port2.

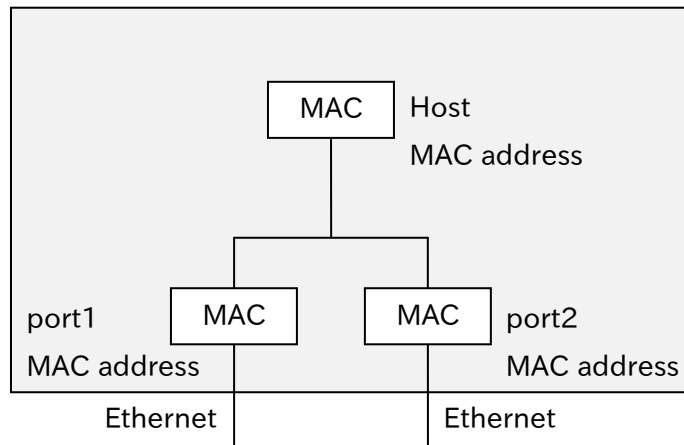

## 8.6 LLDP

LLDP (Link Layer Discovery Protocol) is a function to transmit own device information to the neighbor devices at a fixed interval.

LLDP packet consists of multiple TLV (type-length-value). A TLV consists of 3 fields (type, length, and value) and expresses a kind of information. In the case of following figure, length is n.

Type	Length	Value
7 bits	9 bits	n bit

Please refer to the following subsection about the details of TLV of P1-PN, and IEEE802.1AB-2009 about LLDP.

### 8.6.1 chassis ID

This data indicates the P1-PN information.

Item		Length	Value
Type		7 bits	1
Length		9 bits	n+1
Value	chassis ID subtype	1 byte	4 : MAC address of this port 7 : Device name (NameOfStation)
	chassis ID	n bytes	When the device name (NameOfStation) is set to P1-PN, this data is device name (NameOfStation). When the device name (NameOfStation) isn't set to P1-PN, this data is MAC address of this port.

### 8.6.2 port ID

This data indicates the port information at which P1-PN transmits LLDP packet.

Item		Length	Value
Type		7 bits	2
Length		9 bits	9
Value	port ID subtype	1 byte	7
	port ID	8 bytes	port 1 : port-001 port 2 : port-002

### 8.6.3 Time To Live

This data indicates the seconds which is retention time.

Item		Length	Value
Type		7 bits	3
Length		9 bits	9
Value	Time To Live	1 byte	20

### 8.6.4 LLDP\_PNIO\_PORTSTATUS

This data is particular TLV to PROFINET, and indicates the PROFINET port information.

OUI (Organizationally Unique Identifier) is the unique identifier. OUI which is 0x00 0x0E 0xCF indicates PROFINET.

P1-PN doesn't support RTClass2 and RTClass3.

Item		Length	Value
Type		7 bits	0x7F
Length		9 bits	8
Value	OUI	3 bytes	0x00 0x0E 0xCF
	subtype	1 byte	2
	RTClass2 port status	2 bytes	0
	RTClass3 port status	2 bytes	0

### 8.6.5 LLDP\_PNIO\_CHASSIS\_MAC

This data is particular TLV to PROFINET, and indicates the device information.

Item		Length	Value
Type		7 bits	0x7F
Length		9 bits	10
Value	OUI	3 bytes	0x00 0x0E 0Xcf
	subtype	1 byte	5
	MAC address	6 bytes	MAC address of host

### 8.6.6 LLDP8023MACPHY

This data is particular TLV to IEEE802.3 (Ethernet), and indicates the information about Ethernet. OUI which is 0x00 0x12 0x0F indicates IEEE802.3.

Item		Length	Value
Type		7 bits	0x7F
Length		9 bits	9
Value	OUI	3 bytes	0x00 0x12 0x0F
	subtype	1 byte	1
	auto negotiation	1 byte	3 Bit 0 indicates that P1-PN supports Auto negotiation. Bit 1 indicates that Auto negotiation is active.
	transmission speed	2 bytes	0x0400 Bit 11 indicates that P1-PN supports 100BASE-TX. The other bits indicate that P1-PN doesn't support the other transmission speed.
	actually transmission speed	2 bytes	0x0010 This indicates that the transmission speed is 100BASE-TX Full.

### 8.6.7 LLDPManagement

This data indicates the management information. OID (Object Identifier) is enterprise number of PI.

Item		Length	Value
Type		7 bits	1
Length		9 bits	n+1
Value	Management address length	1 byte	5
	Management address subtype	1 byte	1
	Management address	4 bytes	IP address
	Interface numbering subtype	1 byte	2
	Interface number	4 bytes	1
	OID length	1 byte	8
	OID	8 bytes	0x2B 0x06 0x01 0x04 0x01 0x81 0xC0 0x6E This indicates that OID is '1.3.6.1.4.1.24686' .

**8.6.8** End

This data indicates the end of LLDP packet.

Item	Length	Value
Type	7 bits	0
Length	9 bits	0

## 8.7 SNMP

Please refer to following section about the OIDs (Object Identifier) that P1-PN supports. The “access” and “type” shall be as follows.

Access	Meaning
R	Read only
W	Write only
RW	Read and write
N	Not accessible

Data type	Expression in tables	Meaning
Integer	INT*	Singed integer. "*" indicates bit length.
Octet string	OS[*]	Byte strings. "*" indicates the number of characters. No "*" means read only data.
Object identifier	OID	Object identifier
IpAddress	IpAddress	IP address. This is Octet string has 4 characters.
Counter32	Counter32	From 0 to 4294967295.
Unsigned32	UINT32	From 0 to 4294967295.
Gauge32	Gauge32	From 0 to 4294967295.
TimeTicks	TimeTicks	From 0 to 4294967295. This indicates the time in hundredths of a second between two epochs.
Opaque	Opaque	Octet string
Counter64	Counter64	From 0 to 18446744073709551615.

## 8.7.1 MIB-2

OID	Object name	Access	Type
1.3.6.1.2.1.1.1	sysDescr	R	OS
1.3.6.1.2.1.1.2	sysObjectID	R	OID
1.3.6.1.2.1.1.3	sysUpTime	R	TimeTicks
1.3.6.1.2.1.1.4	sysContact	RW	OS[255]
1.3.6.1.2.1.1.5	sysName	RW	OS[255]
1.3.6.1.2.1.1.6	sysLocation	RW	OS[255]
1.3.6.1.2.1.1.7	sysServices	R	INT
1.3.6.1.2.1.2.1	ifNumber	R	INT32
1.3.6.1.2.1.2.2	ifTable	N	
1.3.6.1.2.1.2.2.1	ifEntry	N	
1.3.6.1.2.1.2.2.1.1	ifIndex	R	INT32
1.3.6.1.2.1.2.2.1.2	ifDescr	R	OS
1.3.6.1.2.1.2.2.1.3	ifType	R	INT
1.3.6.1.2.1.2.2.1.4	ifMtu	R	INT32
1.3.6.1.2.1.2.2.1.5	ifSpeed	R	Gauge32
1.3.6.1.2.1.2.2.1.6	ifPhysAddress	R	OS[6]
1.3.6.1.2.1.2.2.1.7	ifAdminStatus	R	INT
1.3.6.1.2.1.2.2.1.8	ifOperStatus	R	INT
1.3.6.1.2.1.2.2.1.9	ifLastChange	R	TimeTicks
1.3.6.1.2.1.2.2.1.10	ifInOctets	R	Counter32
1.3.6.1.2.1.2.2.1.11	ifInUcastPkts	R	Counter32
1.3.6.1.2.1.2.2.1.12	ifInNUcastPkts	R	Counter32
1.3.6.1.2.1.2.2.1.13	ifInDiscards	R	Counter32
1.3.6.1.2.1.2.2.1.14	ifInErrors	R	Counter32
1.3.6.1.2.1.2.2.1.15	ifInUnknownProtos	R	Counter32
1.3.6.1.2.1.2.2.1.16	ifOutOctets	R	Counter32
1.3.6.1.2.1.2.2.1.17	ifOutUcastPkts	R	Counter32
1.3.6.1.2.1.2.2.1.18	ifOutNUcastPkts	R	Counter32
1.3.6.1.2.1.2.2.1.19	ifOutDiscards	R	Counter32
1.3.6.1.2.1.2.2.1.20	ifOutErrors	R	Counter32
1.3.6.1.2.1.2.2.1.21	ifOutQLen	R	Gauge32
1.3.6.1.2.1.2.2.1.22	ifSpecific	R	OID



## 8.7.2 LLDP-MIB

OID	Object name	Access	Type
1.0.8802.1.1.2	IldpMIB	N	
1.0.8802.1.1.2.1	IldpObjects	N	
1.0.8802.1.1.2.1.1	IldpConfiguration	N	
1.0.8802.1.1.2.1.1.7	IldpConfigManAddrTable	N	
1.0.8802.1.1.2.1.1.7.1	IldpConfigManAddrEntry	N	
1.0.8802.1.1.2.1.1.7.1.1	IldpConfigManAddrPortsTxEnable	R	OS[1]
1.0.8802.1.1.2.1.3	IldpLocalSystemData	N	
1.0.8802.1.1.2.1.3.1	IldpLocChassisIdSubtype	R	INT
1.0.8802.1.1.2.1.3.2	IldpLocChassisId	R	OS[255]
1.0.8802.1.1.2.1.3.3	IldpLocSysName	R	OS[255]
1.0.8802.1.1.2.1.3.4	IldpLocSysDesc	R	OS[255]
1.0.8802.1.1.2.1.3.5	IldpLocSysCapSupported	R	OS[1]
1.0.8802.1.1.2.1.3.6	IldpLocSysCapEnabled	R	OC[1]
1.0.8802.1.1.2.1.3.7	IldpLocPortTable	N	
1.0.8802.1.1.2.1.3.7.1	IldpLocPortTableEntry	N	
1.0.8802.1.1.2.1.3.7.1.1	IldpLocPortNum	N	INT32
1.0.8802.1.1.2.1.3.7.1.2	IldpLocPortIdSubtype	R	INT
1.0.8802.1.1.2.1.3.7.1.3	IldpLocPortId	R	OS[255]
1.0.8802.1.1.2.1.3.7.1.4	IldpLocPortDesc	R	OS[255]
1.0.8802.1.1.2.1.3.8	IldpLocManAddrTable	N	
1.0.8802.1.1.2.1.3.8.1	IldpLocManAddrEntry	N	
1.0.8802.1.1.2.1.3.8.1.1	IldpLocManAddrSubtype	N	INT
1.0.8802.1.1.2.1.3.8.1.2	IldpLocManAddr	N	OS[31]
1.0.8802.1.1.2.1.3.8.1.3	IldpLocManAddrLen	R	INT32
1.0.8802.1.1.2.1.3.8.1.4	IldpLocManAddrIfSubtype	R	INT
1.0.8802.1.1.2.1.3.8.1.5	IldpLocManAddrIfId	R	INT32
1.0.8802.1.1.2.1.3.8.1.6	IldpLocManAddrOID	R	OID
1.0.8802.1.1.2.1.4	IldpRemoteSystemsData	N	
1.0.8802.1.1.2.1.4.1	IldpRemTable	N	
1.0.8802.1.1.2.1.4.1.1	IldpRemEntry	N	
1.0.8802.1.1.2.1.4.1.1.1	IldpRemTimeMark	N	TimeTicks
1.0.8802.1.1.2.1.4.1.1.2	IldpRemLocalPortNum	N	INT32
1.0.8802.1.1.2.1.4.1.1.3	IldpRemIndex	N	INT32
1.0.8802.1.1.2.1.4.1.1.4	IldpRemChassisIdSubtype	R	INT
1.0.8802.1.1.2.1.4.1.1.5	IldpRemChassisId	R	OS[255]
1.0.8802.1.1.2.1.4.1.1.6	IldpRemPortIdSubtype	R	INT
1.0.8802.1.1.2.1.4.1.1.7	IldpRemPortId	R	OS[255]
1.0.8802.1.1.2.1.4.1.1.8	IldpRemPortDesc	R	OS[255]
1.0.8802.1.1.2.1.4.1.1.9	IldpRemSysName	R	OS[255]
1.0.8802.1.1.2.1.4.1.1.10	IldpRemSysDesc	R	OS[255]
1.0.8802.1.1.2.1.4.1.1.11	IldpRemSysCapSupported	R	OS[1]
1.0.8802.1.1.2.1.4.1.1.12	IldpRemSysCapEnabled	R	OS[1]
1.0.8802.1.1.2.1.4.2	IldpRemManAddrTable	N	
1.0.8802.1.1.2.1.4.2.1	IldpRemManAddrEntry	N	
1.0.8802.1.1.2.1.4.2.1.1	IldpRemManAddrSubtype	N	INT

OID	Object name	Access	Type
1.0.8802.1.1.2.1.4.2.1.2	IldpRemManAddr	N	OS[31]
1.0.8802.1.1.2.1.4.2.1.3	IldpRemManAddrIfSubtype	R	INT
1.0.8802.1.1.2.1.4.2.1.4	IldpRemManAddrIfId	R	INT32
1.0.8802.1.1.2.1.4.2.1.5	IldpRemManAddrOID	R	OID

### 8.7.3 LLDP-EXT-PNIO-MIB

OID	Object name	Access	Type
1.0.8802.1.1.2.1.5	IldpExtensions	N	
1.0.8802.1.1.2.1.5.3791	IldpXPnoMIB	N	
1.0.8802.1.1.2.1.5.3791.1	IldpXPnoObjects	N	
1.0.8802.1.1.2.1.5.3791.1.2	IldpXPnoLocalData		
1.0.8802.1.1.2.1.5.3791.1.2.1	IldpXPnoLocTable	N	
1.0.8802.1.1.2.1.5.3791.1.2.1.1	IldpXPnoLocEntry	N	
1.0.8802.1.1.2.1.5.3791.1.2.1.1.1	IldpXPnoLocLPDValue	R	UINT32
1.0.8802.1.1.2.1.5.3791.1.2.1.1.2	IldpXPnoLocPortTxDValue	R	UINT32
1.0.8802.1.1.2.1.5.3791.1.2.1.1.3	IldpXPnoLocPortRxDValue	R	UINT32
1.0.8802.1.1.2.1.5.3791.1.2.1.1.6	IldpXPnoLocPortNoS	R	OS[255]
1.0.8802.1.1.2.1.5.3791.1.3	IldpXPnoRemoteData		
1.0.8802.1.1.2.1.5.3791.1.3.1	IldpXPnoRemTable	N	
1.0.8802.1.1.2.1.5.3791.1.3.1.1	IldpXPnoRemEntry	N	
1.0.8802.1.1.2.1.5.3791.1.3.1.1.1	IldpXPnoRemLPDValue	R	UINT32
1.0.8802.1.1.2.1.5.3791.1.3.1.1.2	IldpXPnoRemPortTxDValue	R	UINT32
1.0.8802.1.1.2.1.5.3791.1.3.1.1.3	IldpXPnoRemPortRxDValue	R	UINT32
1.0.8802.1.1.2.1.5.3791.1.3.1.1.6	IldpXPnoRemPortNoS	R	OS[255]

### 8.7.4 LLDP-EXT-DOT3-MIB

OID	Object name	Access	Type
1.0.8802.1.1.2.1.5.4623	IldpXdot3MIB	N	
1.0.8802.1.1.2.1.5.4623.1	IldpXdot3Objects	N	
1.0.8802.1.1.2.1.5.4623.1.2	IldpXdot3LocalData		
1.0.8802.1.1.2.1.5.4623.1.2.1	IldpXdot3LocPortTable	N	
1.0.8802.1.1.2.1.5.4623.1.2.1.1	IldpXdot3LocPortEntry	N	
1.0.8802.1.1.2.1.5.4623.1.2.1.1.1	IldpXdot3LocPortAutoNegSupported	R	INT
1.0.8802.1.1.2.1.5.4623.1.2.1.1.2	IldpXdot3LocPortAutoNegEnabled	R	INT
1.0.8802.1.1.2.1.5.4623.1.2.1.1.3	IldpXdot3LocPortAutoNegAdvertisedCa p	R	OS[2]
1.0.8802.1.1.2.1.5.4623.1.2.1.1.4	IldpXdot3LocPortOperMauType	R	INT32
1.0.8802.1.1.2.1.5.4623.1.3	IldpXdot3RemoteData	N	
1.0.8802.1.1.2.1.5.4623.1.3.1	IldpXdot3RemPortTable	N	
1.0.8802.1.1.2.1.5.4623.1.3.1.1	IldpXdot3RemPortEntry	N	
1.0.8802.1.1.2.1.5.4623.1.3.1.1.1	IldpXdot3RemPortAutoNegSupported	R	INT
1.0.8802.1.1.2.1.5.4623.1.3.1.1.2	IldpXdot3RemPortAutoNegEnabled	R	INT
1.0.8802.1.1.2.1.5.4623.1.3.1.1.3	IldpXdot3RemPortAutoNegAdvertisedC ap	R	OS[2]
1.0.8802.1.1.2.1.5.4623.1.3.1.1.4	IldpXdot3RemPortOperMauType	R	INT32

## 8.8 MRP

MRP (Media Redundancy Protocol) is defined in IEC 62439. If the network is ring topology and a network error occurs, transmission path is automatically switched and PROFINET transmission is continued.

When you use MRP, a MRP manager is needed in this network.

## 9



# Chapter 9 About the PROFIdrive

## Contents

9.1 About this chapter.....	9-1
9.2 PROFIdrive.....	9-2
9.3 State machine on PROFIdrive.....	9-3
9.3.1 State diagram.....	9-3
9.3.2 Description each state .....	9-5
9.4 STW1 (Control word 1).....	9-5
9.5 ZSW1 (Status word 1) .....	9-6
9.6 NSOLL_A / NIST_A .....	9-8
9.7 Telegram .....	9-9
9.7.1 Standard telegram 1 .....	9-9
9.7.2 P1-PN telegram 103 - 105.....	9-9
9.8 Parameter access .....	9-11
9.8.1 write data record and read data record .....	9-11
9.8.2 Parameter access on PROFIdrive.....	9-12
9.9 Fault.....	9-17
9.10 Warning .....	9-18
9.11 Operation example .....	9-19

## 9.1 About this chapter

This chapter contains the explanation about the PROFIdrive.

Symbol	Definition
	Questions about a particular situation.
	Solution/Answer
	Precautions

## 9.2 PROFIdrive

The P1-PN supports below function about PROFIdrive.

Item	Specification
Version	4.2
Application class	AC1 (Standard Drive)
Telegram	Standard telegram 1 P1-PN telegram 103 (same as PPO3 of PROFIdrive version 2) P1-PN telegram 104 (same as PPO4 of PROFIdrive version 2) P1-PN telegram 105 (like PPO5 of PROFIdrive version 2)
Configuring of telegram	Supported From oJ-01 to oJ-60 of SJ-P1 parameters
Operating mode	Speed control mode
Jogging	Only jogging 1 is supported.

The size of send and receive data of each telegram are the following.

P1-PN telegrams are the device specific telegrams and compatible with PPOs of PROFIdrive version 2. However, P1-PN telegram doesn't have PKW (parameter area) and has only PZD (process data area).

Telegram	Setpoint	Actual value
Standard telegram 1	2 word	2 word
P1-PN telegram 103 (same as PPO3 of PROFIdrive version 2)	2 word	2 word
P1-PN telegram 104 (same as PPO4 of PROFIdrive version 2)	6 word	6 word
P1-PN telegram 105 (like PPO5 of PROFIdrive version 2)	10 word	10 word

(\*) Setpoint : data from Master to Slave

Actual value : data from Slave to Master

Please refer to "9.7 Telegram" for details of each telegram.

### 9.3 State machine on PROFIdrive

#### 9.3.1 State diagram

The state diagram of P1-PN is below.

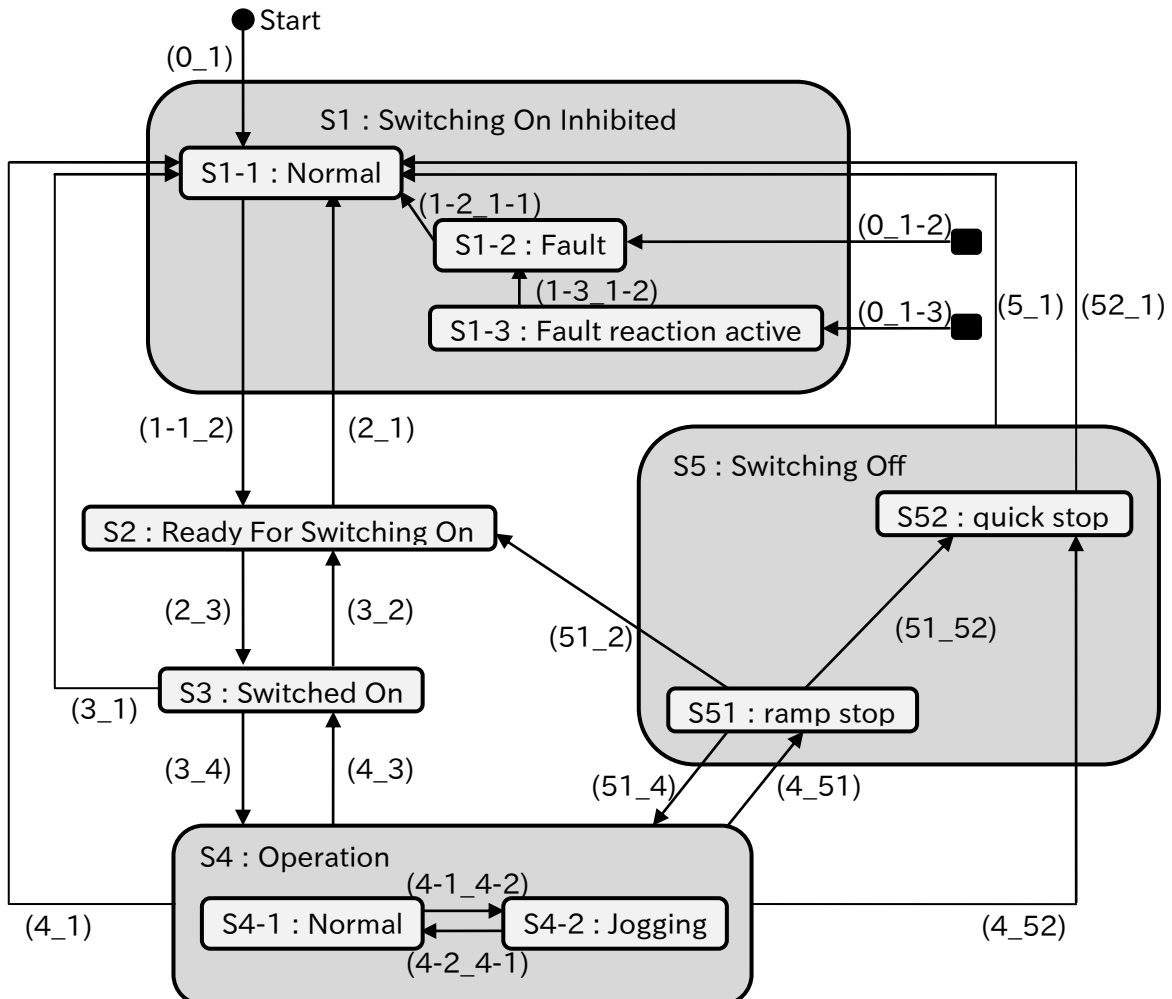

Note : The black rounded rectangles means every states. The states of "S1-2 : Fault" and "S1-3 : Fault reaction active" can be transitioned from any states.

Each transition is the following. Upper transition is given priority.

Transition source	Transition	Condition
From initial state	(0_1)	Power on, or reset.
In case of error.	(0_1-3)	When SJ-P1 is on the operation and either of the following conditions are satisfied. <ul style="list-style-type: none"> <li>- The communication error is occurred between P1-PN and SJ-P1.</li> <li>- The communication timeout error that it has been the time of oA-11 / 21 / 31 since previous communication occurs on PROFINET and oA-12 / 22 / 32 = 1.</li> </ul>
	(0_1-2)	When except the above error occurs.
From S1-1	(1-1_2)	When all of the following conditions of STW1 are satisfied. Bit0 = OFF, Bit1 = ON, Bit2 = ON
From S1-2	(1-2_1-1)	When STW1 Bit7 becomes from OFF to ON and keeps ON for at least 20ms.
From S1-3	(1-3_1-2)	When oA-11 / 21 / 31 = 1 and any errors occur, SJ-P1 decelerates and the output frequency of SJ-P1 becomes 0.00 [Hz].
From S2	(2_1)	When either of the following conditions of STW1 is satisfied. Bit1 = OFF, Bit2 = OFF
	(2_3)	STW1 Bit0 = ON
From S3	(3_1)	When either of the following conditions of STW1 is satisfied. Bit1 = OFF, Bit2 = OFF
	(3_2)	STW1 Bit0 = OFF
	(3_4)	STW1 Bit3 = ON
From S4	(4_1)	STW1 Bit1 = OFF
	(4_52)	When either of the following conditions are satisfied. <ul style="list-style-type: none"> <li>- STW1 Bit2 = OFF</li> <li>- STW1 Bit0 = ON ƒ Bit4 = OFF</li> </ul>
	(4_51)	STW1 Bit0 = OFF
	(4_3)	STW1 Bit3 = OFF
From S4-1	(4-1_4-2)	When all of the following conditions are satisfied. <ul style="list-style-type: none"> <li>- The output frequency of SJ-P1 is 0.00 [Hz].</li> <li>- All of STW1 Bit 4- 6 are OFF.</li> <li>- STW1 Bit 8 is ON</li> </ul>
From S4-2	(4-2_4-1)	When all of the following conditions are satisfied. <ul style="list-style-type: none"> <li>- The output frequency of SJ-P1 is 0.00 [Hz].</li> <li>- Either of STW1 Bit 4- 6 is ON.</li> <li>- STW1 Bit 8 is OFF</li> </ul>
From S5	(5_1)	STW1 Bit1 = OFF
From S51	(51_52)	STW1 Bit2 = OFF
	(51_2)	When either of the following conditions are satisfied. <ul style="list-style-type: none"> <li>- The output frequency of SJ-P1 is 0.00 [Hz].</li> <li>- STW1 Bit 3 = OFF.</li> </ul>
	(51_4)	STW1 Bit0 = ON
From S52	(52_1)	When either of the following conditions are satisfied. <ul style="list-style-type: none"> <li>- The output frequency of SJ-P1 is 0.00 [Hz].</li> <li>- STW1 Bit 3 = OFF.</li> </ul>

### 9.3.2 Description each state

State		Description
S1	Switching On Inhibited	Inverter is stopping.
S1-1	Normal	Errors don't occur in inverter.
S1-2	Fault	An error occurs in inverter and the error isn't cleared.
S1-3	Fault reaction active	P1-PN detects an error, and inverter is during deceleration. When inverter stops, P1-PN makes inverter trip and changes the state to S1-2.
S2	Ready For Switching On	Inverter is stopping.
S3	Switched On	Inverter is stopping.
S4	Operation	Inverter can be operated.
S4-1	Normal	Inverter is running normally.
S4-2	Jogging	Inverter is running by jogging.
S5	Switching Off	Inverter is decelerating.
S51	ramp stop	Inverter is decelerating by ramp stop.
S52	quick stop	Inverter is decelerating by quick stop (2ch function of SJ-P1).

The state S\*-\* aren't defined at the figure of General State Diagram in the PROFIdrive specification.

## 9.4 STW1 (Control word 1)

The size of STW1 is 16 bits.

The specification of each bit is the following.

Bit	Value	Significance	Description
0	1	ON	When the state is in "Ready For Switching On", the state is changed to "Switched On". When the state is in "ramp stop", the state is changed to "Operation".
	0	OFF (OFF 1)	When the state is in "Switched On", the state is changed to "Ready For Switching On". When the state is in "Operation", the state is changed to "ramp stop" and inverter decelerates by ramp stop.
1	1	No Coast Stop (no OFF 2)	When the state is in "Switching On Inhibited" and STW1 bit2 is ON, the state is changed to "Ready For Switching On".
	0	Coast Stop (OFF 2)	When the state is in "Ready For Switching On" or "Switched On", the state is changed to "Switching On Inhibited". When the state is in "Operation" or "Switching Off (ramp stop or quick stop)", the state is changed to "Switching On Inhibited" and inverter stops by coast stop.
2	1	No Quick Stop (no OFF 3)	When the state is in "Switching On Inhibited" and STW1 bit1 is ON, the state is changed to "Ready For Switching On".
	0	Quick Stop (OFF 3)	When the state is in "Ready For Switching On" or "Switched On", the state is changed to "Switching On Inhibited". When the state is in "Operation" or "ramp stop", the state is changed to "quick stop" and inverter decelerates by 2ch function of SJ-P1.



Bit	Value	Significance	Description
3	1	Enable Operation	When the state is in “Switched On” , the state is changed to “Operation” .
	0	Disable Operation	When the state is in “ramp stop” , the state is changed to “Ready For Switching On” . When the state is in “quick stop” , the state is changed to “Switching On Inhibited” .
4	1	Enable Ramp Generator	The output frequency is set Speed Setpoint A (NSOLL_A) and inverter accelerates.
	0	Reset Ramp Generator	The output frequency is set 0.00 [Hz]. When inverter is running and both this bit and bit 0 are changed from 1 to 0, inverter decelerates by 2CH function of SJ-P1.
5	1	Unfreeze Ramp Generator	The output frequency isn't held.
	0	Freeze Ramp Generator	The output frequency is held.
6	1	Enable Setpoint	The output frequency is set Speed Setpoint A (NSOLL_A).
	0	Disable Setpoint	The output frequency is set 0.00 [Hz].
7	1	Fault Acknowledge (0 -> 1)	When this bit is changed from 0 to 1, errors are cleared.
	0	No significance	Do nothing.
8	1	Jog 1 ON	When the state is “Operation” , the output frequency is 0.00 [Hz] and bit4 - 6 are 0, inverter runs by jogging.
	0	Jog 1 OFF	When inverter runs by jogging, Inverter stops.
9	1	Jog 2 ON	Not supported
	0	Jog 2 OFF	
10	1	Control By PLC	Inverter can be controled by PLC.
	0	No Control By PLC	Inverter can't be controled by PLC.
11	1	Reverse	Inverter runs in reverse direction.
	0	Forward	Inverter runs in forward direction.
12 - 15			Reserved

Bit 11 is device specific.

## 9.5 ZSW1 (Status word 1)

The size of ZSW1 is 16 bits.

The specification of each bit is the following.

Bit	Value	Significance	Description
0	1	Ready To Switch On	When the state isn't “Switching On Inhibited” , this bit is ON.
	0	Not Ready To Switch On	When the state is “Switching On Inhibited” , this bit is OFF.
1	1	Ready To Operate	When the state is “Switched On” , “Operation” or “Switching Off (ramp stop or quick stop)” , this bit is ON.
	0	Not Ready To Operate	When the state is “Switching On Inhibited” or “Ready For Switching On” , this bit is OFF.

Bit	Value	Significance	Description
2	1	Operation Enabled	When the state is "Operation" , this bit is ON.
	0	Operation Disabled	When the state isn't "Operation" , this bit is OFF.
3	1	Fault Present	When error occurs in inverter or P1-PN, this bit is ON.
	0	No Fault	No error occurs in inverter or P1-PN.
4	1	Coast Stop Not Activated (No OFF 2)	When STW1 bit1 is ON, this bit is ON.
	0	Coast Stop Activated (OFF 2)	When STW1 bit1 is OFF, this bit is OFF.
5	1	Quick Stop Not Activated (No OFF 3)	When STW2 bit1 is ON, this bit is ON.
	0	Quick Stop Activated (OFF 3)	When STW2 bit1 is OFF, this bit is OFF.
6	1	Switching On Inhibited	When the state is "Switching On Inhibited" , this bit is ON.
	0	Switching On Not Inhibit	When the state isn't "Switching On Inhibited" , this bit is OFF.
7	1	Warning Present	When warning occurs in inverter or P1-PN, this bit is ON.
	0	No Warning	No warning occurs in inverter or P1-PN.
8	1	Speed Error Within Tolerance Range	When the output frequency reaches the set frequency, this bit is ON.
	0	Speed Error Out Of Tolerance Range	When the output frequency doesn't reach the set frequency, this bit is OFF.
9	1	Control Requested	P1-PN can accept data that is communicated by PROFINET.
	0	No Control Requested	P1-PN can't accept data that is communicated by PROFINET.
10	1	fOr n Reached Or Exceeded	When the output frequency reaches or exceeds the set frequency, this bit is ON. This bit is same as FA2 of SJ-P1. You need to set CE-10 and CE-11.
	0	fOr n Not Reached	When the output frequency doesn't reach and exceed the set frequency, this bit is ON. This bit is same as FA2 of SJ-P1. You need to set CE-10 and CE-11.
11 - 15			Reserved

## 9.6 NSOLL\_A / NIST\_A

NSOLL\_A is Speed setpoint A, means the setting of output frequency. Inverter runs this setting at not jogging but normal operation. When inverter runs at jogging, inverter runs not NSOLL\_A but AG-20 of SJ-P1 parameter.

NIST\_A is Speed actual value A, means the actual output frequency. This value means the actual output frequency at both normal and jogging operations.

The size of these is signed 16 bits data. The sign means direction. The positive value means forward, the negative value means reverse. However, the actual direction depends on both the sign of NSOLL\_A and STW1 bit11.

NSOLL_A	STW1 bit11	ON	OFF
	Positive		Reverse
Negative		Forward	Reverse

The data type of these is N2. The value of N2 means the following.

Value	Significance
-32768 (0x8000)	-200 %
-32767 ~ -1 (0x8001 ~ 0xFFFF)	-199.993896484375 % ~ -0.0061 %
-16384 (0xC000)	-100 %
0 (0x0)	0 %
16384 (0x4000)	100 %
1 ~ 32766 (0x1 ~ 0x7FFE)	0.0061 % ~ 199.98779296875 %
32767 (0x7FFF)	199.993896484375 %

The base frequency of these is set Hb105 / Hd105 of SJ-P1 parameter. The referenced parameter is determined by AA121 automatically.

(Example)

When AA121 = 00, Hb105 = 60.00 [Hz],  
NSOLL\_A = 8192 (0x2000 : 50%), SJ-P1 runs  
30.00 [Hz].

When the absolute value of NSOLL\_A is over 100%, inverter runs 100%.



NIST\_A always depends on A004 even if inverter runs at jogging operation. Therefore, when the output frequency reaches the jogging frequency (AG-20), NIST\_A doesn't equal NSOLL\_A. However, STW1 Bit8 becomes ON.

(Example)

When AA121 = 00, Hb105 = 60.00 [Hz], AG-20 = 6.00 [Hz], NSOLL\_A = 16384 (0x4000 : 100%), SJ-P1 runs 6.00 [Hz] by Jogging and NIST\_A becomes 1638 (0x666 : 10%).

## 9.7 Telegram

### 9.7.1 Standard telegram 1

Setpoint and actual value of Standard telegram 1 are the Following.

I/O Data No.	Setpoint	Actual value
1	STW1	ZSW1
2	NSOLL_A	NIST_A

(\*) Setpoint : data from Master to Slave  
Actual value : data from Slave to Master

### 9.7.2 P1-PN telegram 103 - 105

Setpoint and Actual value of P1-PN telegram 103 - 105 are the following. Send and receive data are the data that you set oJ-01 - oJ-60.

oJ-01 - oJ-60 are divided into 3 groups from Gr.A to Gr.C.  
The group is set by oH-34.

oH-34	Gr.	oJ-**
0	Gr.A	oJ-01 - oJ-20
1	Gr.B	oJ-21 - oJ-40
2	Gr.C	oJ-41 - oJ-60

I/O Data No.	Setpoint	Actual value	P1-PN telegram		
			103	104	105
1	oJ-01 / oJ-21 / oJ-41	oJ-11 / oJ-31 / oJ-51	○	○	○
2	oJ-02 / oJ-22 / oJ-42	oJ-12 / oJ-32 / oJ-52	○	○	○
3	oJ-03 / oJ-23 / oJ-43	oJ-13 / oJ-33 / oJ-53		○	○
4	oJ-04 / oJ-24 / oJ-44	oJ-14 / oJ-34 / oJ-54		○	○
5	oJ-05 / oJ-25 / oJ-45	oJ-15 / oJ-35 / oJ-55		○	○
6	oJ-06 / oJ-26 / oJ-46	oJ-16 / oJ-36 / oJ-56		○	○
7	oJ-07 / oJ-27 / oJ-47	oJ-17 / oJ-37 / oJ-57			○
8	oJ-08 / oJ-28 / oJ-48	oJ-18 / oJ-38 / oJ-58			○
9	oJ-09 / oJ-29 / oJ-49	oJ-19 / oJ-39 / oJ-59			○
10	oJ-10 / oJ-30 / oJ-50	oJ-20 / oJ-40 / oJ-60			○

(\*) Setpoint : data from Master to Slave  
Actual value : data from Slave to Master

You need to set oJ-01 - oJ-60 to 0 or Modbus register number of SJ-P1. If you don't use oJ-\*3 - oJ-\*0 (\* = 0 - 6), you need to set these to 0.

When you set oJ-01 / oJ-21 / oJ-41 to 0, setpoint data is STW1.

When you set oJ-02 / oJ-22 / oJ-42 to 0, setpoint data is NSOLL\_A.

When you set oJ-11 / oJ-31 / oJ-51 to 0, actual value data is ZSW1.

When you set oJ-12 / oJ-32 / oJ-52 to 0, actual value data is NIST\_A.

When you want to set 32bit length data to oJ-01 - oJ-60, you need to set consecutively.

The only row word of 32bit length data can be set, but the only high word of it can't be set.

If you don't set consecutively or the only high word, this parameters aren't sent and received, and PNU 954 bit 4 becomes ON.

The byte order of 32bit length data depends on the setting of oJ-01 - oJ-60.

When you set oJ-\*1 and oJ-\*2 (\* = 0 - 6) to the value that are non-existent Modbus register number, or oJ-\*3 - oJ-\*0 (\* = 0 - 6) to 0 or the value that are non-existent Modbus register number, P1-PN doesn't read and write data to SJ-P1. Therefore P1-PN received data from the master, but P1-PN doesn't set to SJ-P1. Also, since P1-PN doesn't read data from SJ-P1, P1-PN sends 0 to the master.



I want to send the high word of 32bit length data from the master first.



For example, when you want to send FA-10 (Modbus register number 0x2B02 and 0x2B03) on 3rd and 4th word of P1-PN telegram 105, please set the following.

oJ-03 = 0x2B02

oJ-04 = 0x2B03



I want to send the only row word of 32bit length data from P1-PN.



For example, when you want to send the row word of FA-10 (Modbus register number 0x2B03) on 3rd word of P1-PN telegram 105, please set the following.

oJ-03 = 0x2B03



The only high word of 32bit length data can't be sent and received.

## 9.8 Parameter access

You can access the parameter by Record Data CR.

### 9.8.1 write data record and read data record

First you need to send a request of parameter read or write to P1-PN by write data record (e.g. WRREC) from PROFINET IO controller or supervisor.

Next you need to send a request to read the response to P1-PN by read data record (e.g. RDREC) from PROFINET IO controller or supervisor. If there is an error, the reply to a Read or Write service is an error response.

When you access the parameter, you need to set 0xB02E to index.

Please refer to the PROFIdrive specification or a manual of PROFINET IO controller or supervisor that you use.

### 9.8.2 Parameter access on PROFIdrive

The request data frame to parameter access on PROFIdrive is the following.

Word offset	Block	Byte n	Byte n+1
0	Request header	Request reference	Request ID
1		Axis-No. / DO-ID	The number of parameters = i
2	1st Parameter address	Attribute	The number of elements
3		PNU	
4		Subindex	
~ 3i + 1	ith Parameter address		
3i + 2	1st Parameter value	Format	The number of values
3i + 3		value	
		...	
	ith Parameter value		

Nth Parameter values need to be set only for request "Change parameter" . These don't need to be set for request "Request parameter" .

The response data frame to parameter access on PROFIdrive is the following.

Word offset	Block	Byte n	Byte n+1
0	Response header	Request reference = (*)	Request ID
1		Axis-No. / DO-ID = (*)	The number of parameters = i
2	1st Parameter value	Format	The number of values
3		Value or error code	
		...	
	ith Parameter value		

(\*)These are same as the request.

Nth Parameter values exist only for request “Request parameter” .

You can access multi parameters at a request message. However, when an error occurs, there are cases that the process is stopped and returns the response. This depends on kind of errors. You need to resolve/investigate what process has been done by checking the returned message, because P1-PN will stop the internal transaction immediately and return the message when the requested command/address was wrong. For example, when you set the wrong data type like the right column request, the process is stopped and returns the response. The following values are hexadecimal.

[The request] (\*) The underline part is the wrong data.

```
01 02 01 03 10 01 04 19 00 AF 10 01 07 FB 00
59 10 01 07 FB 00 5B 06 01 02 58 06 01 00 00
0B B8 07 01 00 00 0B B8
```

[The response] (\*) The underline parts show error.

```
01 82 01 02 40 00 44 01 00 05
```



The descriptions of data are the following.

Block	Field	Data type	Description
Request Header	Request Reference	Unsigned8	The message ID. Unique ID of the request / response pair for the master. Reserved : 0x00 ID : 0x01 - 0xFF
	Request ID	Unsigned8	The type of request data. Request parameter : 0x01 Change parameter : 0x02
	Response ID	Unsigned8	The type of response data. Request parameter (+) : 0x01 Request parameter (-) : 0x81 Change parameter (+) : 0x02 Change parameter (-) : 0x82 Unsupported service : 0x80 (Request ID is 0x00, 0x80 and more)
	Axis-No. / DO-ID	Unsigned8	Axis-No. / DO-ID that you access. You need to set 0x00 or 0x01 in P1-PN.
	No. of Parameters	Unsigned8	The number of parameters. You can set from 1 to 39 in PROFINET.
Parameter Address	Attribute	Unsigned8	The type of parameter that you access. Value : 0x10 Description : 0x20 Text : 0x30
	Number of Elements	Unsigned8	When the parameter that you access is Array or String, this parameter means the number of elements. You can set from 1 to 234. When the parameter that you access is the other, you need to set 0.
	Parameter Number	Unsigned16	Parameter number Reserved : 0x0000 Parameter number : 0x0001 - 0xFFFF
	Subindex	Unsigned16	The subindex of parameter : 0x0000 - 0xFFFE
Parameter Value	Format	Unsigned8	The data type of values. Unsigned16 : 0x06 Unsigned32 : 0x07 Octet string : 0x0A V2 (*) : 0x73 Zero : 0x40 (The response value doesn't exist.) Byte : 0x41 Word : 0x42 Double word : 0x43 Error : 0x44
	Number of Values	Unsigned8	The number of values. This value is from 0 to 234.

Block	Field	Data type	Description
	Values	Depend on data	The value that you read or change.
	Error value 1	Unsigned16	Error code : 0x0000 - 0x00FF (The lower byte is the error code.)
	Error value 2	Unsigned16	It depends on an error value 1 whether this data exist. This value shows the subindex of the first array element where the error occurs.

(\*) V2 is boolean variables are combined in two octets. Refer to the specification of PROFIdrive for detail.

The error codes are the following.

Error No. = Error value 1	Meaning	Used at	Additional info = Error value 2
0x00	Impermissible parameter number	Access to unavailable parameter	0
0x01	Parameter value cannot be changed	Change access to a parameter value that cannot be changed	Subindex
0x02	Low or high limit exceeded	Change access with value outside the value limits	Subindex
0x03	Faulty subindex	Access to unavailable subindex of array or string parameter. Shall not be used for single parameters	Subindex
0x04	No array	Access with subindex to non-indexed Parameter	0
0x05	Incorrect data type	Change access with value that does not match the data type of the parameter	0
0x06	Setting not permitted (may only be reset)	Change access with value unequal to 0 where this is not permitted	Subindex
0x07	Description element cannot be Changed	Change access to a description element that cannot be changed	Subindex
0x09	No description data available	Access to unavailable description (parameter value is available)	0
0x0B	No operation priority	Change access without rights to change Parameters	0
0x0F	No text array available	Access to text array that is not available (parameter value is available)	0
0x11	Request cannot be executed because of operating state	Access is temporarily not possible for reasons that are not specified in detail. When the parameter of SJ-P1 is accessed, please check whether the inverter can accept change access.	0
0x14	Value impermissible	Change access with a value that is within the value limits, but is not permissible for other long-term reasons (parameter with defined single values)	Subindex

Error No. = Error value 1	Meaning	Used at	Additional info = Error value 2
0x15	Response too long	The length of the current response exceeds the maximum transmittable length of the response transport block. In case of a multi parameter request, the response block was shortened by omitting of parameter requests.	0
0x16	Parameter address impermissible	Illegal value (reserved) or value which is not supported for the attribute, illegal or not supported number of elements, illegal parameter number or illegal subindex or a combination	0
0x17	Illegal format	Write request: Illegal format or format of the parameter data which is not supported	0
0x18	Number of values are not consistent	Write request: Number of the values of the parameter data do not match the number of elements in the parameter address	0
0x19	Axis/DO nonexistent	Access to an Axis/DO which does not exist	0
0x20	Parameter text element cannot be Changed	Change access to a parameter text element that cannot be changed	Subindex
0x21	Service not supported	Illegal or unknown Request ID (Response ID = 0x80)	-
0x22	Too much parameter requests	Multi parameter request: The response block does not contain all parameter responses because of maximum number of supported parameter requests per multi parameter request was exceeded.	-
0x23	Multi parameter access not Supported	Device parameter manager does not support multi parameter requests. Request is discarded.	-
0x65 0x67	Error of access to SJ-P1 (Manufacturer-specific)	It is an error of access to SJ-P1. You access while SJ-P1 is initializing or changing the mode. If P1-PN returns these values while SJ-P1 isn't initializing or changing the mode, please contact the nearest business contact.	-

## 9.9 Fault

When P1-PN detects a fault, P1-PN stores the fault code into the fault buffer.

[The sequence to store the fault code into the fault buffer]

- The fault code is stored into PNU 947's the smallest subindex that hasn't still been stored from 0 to 7. When subindex 0 - 7 have already been stored to, subindex 7 is overwritten.
- PNU 944 is increased by 1.
- ZSW1 bit3 is changed to ON.

[The sequence to acknowledge the fault buffer]

- When STW1 bit 7 is changed from OFF to ON and is ON for 20ms or more, to acknowledge the fault buffer starts.
- The data of subindex 48 - 55 of PNU 947 are copied to subindex 56 - 63.
- The data of subindex 40 - 47 of PNU 947 are copied to subindex 48 - 55.
- The data of subindex 32 - 39 of PNU 947 are copied to subindex 40 - 47.
- The data of subindex 24 - 31 of PNU 947 are copied to subindex 32 - 39.
- The data of subindex 16 - 23 of PNU 947 are copied to subindex 24 - 31.
- The data of subindex 8 - 15 of PNU 947 are copied to subindex 16 - 23.
- The data of subindex 0 - 7 of PNU 947 are copied to subindex 8 - 15.
- 0 is stored into subindex 0 - 7 of PNU 947.
- PNU 952 is increased by 1.
- PNU 944 is increased by 1.
- If trip is occurred in SJ-P1, trip reset is sent to SJ-P1.
- ZSW1 bit3 is changed to OFF.

[The sequence to clear the fault buffer]

- When PNU952 is written 0, to clear the fault buffer starts.
- The data of all subindices of PNU 947 are cleared to 0.
- PNU 944 is changed to 0.

The fault codes are the following.

Fault	Fault code	Description
Trip of SJ-P1	Trip code	Trip was occurred in SJ-P1.
Timeout error of PROFINET	Trip code 63 / 73 / 83	The timeout error was occurred on PROFINET.
The rotary switches error	Trip code 65 / 75 / 85	The rotary switches of P1-PN couldn't be read normally.
Communication error between P1-PN and SJ-P1	0xFF01	Communication error was occurred between P1-PN and SJ-P1.

Please refer to the PROFIdrive specification for details of the fault mechanism.

## 9.10 Warning

When P1-PN detects warning, the warning code is stored to PNU 953 and PNU 954, and ZSW1 bit 7 is changed to ON.

The specification of PNU953 is same as dE-50 of SJ-P1.

The specification that each bit of PNU954 becomes ON is the following.

PNU 954 bit	Conditions
3	The Modbus register number that doesn't exist is assigned in oJ-01 - oJ-60.
4	The 32bit length Modbus register number isn't assigned in oJ-01 - oJ-60 consecutively, or the high word of 32bit length Modbus register number is assigned in oJ-01 - oJ-60.
7	$oJ-11 / oJ-31 / oJ-51 = 0$ (ZSW1), but $oJ-01 / oJ-21 / oJ-41 \neq 0$ (STW1)
8	The sequence of upper and lower of the 32bit length Modbus register No. differ in selected telegram.
9	The read only parameter is assigned in oJ-01 - oJ-10 / oJ-21 - oJ-30 / oJ-41 - oJ-50.

Please refer to the user's guide of SJ-P1 about PNU953.

Even if the warning about PNU954 occurs, the inverter can run.

## 9.11 Operation example

The following is an example of operation with the following settings.

- [AA121] = 00 (VF control (Constant torque))
- [Hb105] = 60.00 [Hz] (Maximum frequency)
- Telegram = Standard Telegram 1
- The others parameter = Default value

[Setpoint (Master -> Slave)]

- ① Setting STW1 to 0x0406.
- ② Setting STW1 to 0x0407.
- ③ Setting STW1 to 0x047F.
- ④ Setting NSOLL\_A to 0x4000 (100%).
- ⑤ Setting NSOLL\_A to 0x1000 (25%).
- ⑥ Setting NSOLL\_A to 0x0 (0%).
- ⑦ Setting NSOLL\_A to 0xC000 (-100%).
- ⑧ Setting NSOLL\_A to 0x0 (0%).

[Actual value (Slave -> Master)]

- ⑨ Stopping state, PROFIdrive transition to “Ready For switching On” .
- ⑩ Stopping state, PROFIdrive transition to “Switching On” .
- ⑪ Driving with 0x0 (0% : 0.00 [Hz]) state, PROFIdrive transition to “Operation” .
- ⑫ Accelerating in forward direction, “XXXX” indicates NIST\_A during acceleration.
- ⑬ Driving at a constant speed state, NIST\_A is equal to 0x4000 (100% : 60.00 [Hz]).
- ⑭ Deceleration state, “XXXX” indicates NIST\_A during deceleration.
- ⑮ Driving at a constant speed state, NIST\_A is equal to 0x1000 (25% : 15.00 [Hz]).
- ⑯ Deceleration state, “XXXX” indicates NIST\_A during deceleration.
- ⑰ Driving at a constant speed state, NIST\_A is equal to 0x0 (0% : 0.00 [Hz]).
- ⑱ Accelerating in reverse direction, “XXXX” indicates NIST\_A during deceleration.
- ⑲ Driving at a constant speed state, NIST\_A is equal to 0xC000 (-100% : -60.00 [Hz]).
- ⑳ Deceleration state, “XXXX” indicates NIST\_A during deceleration.
- ㉑ Driving at a constant speed state, NIST\_A is equal to 0x0 (0% : 0.00 [Hz]).

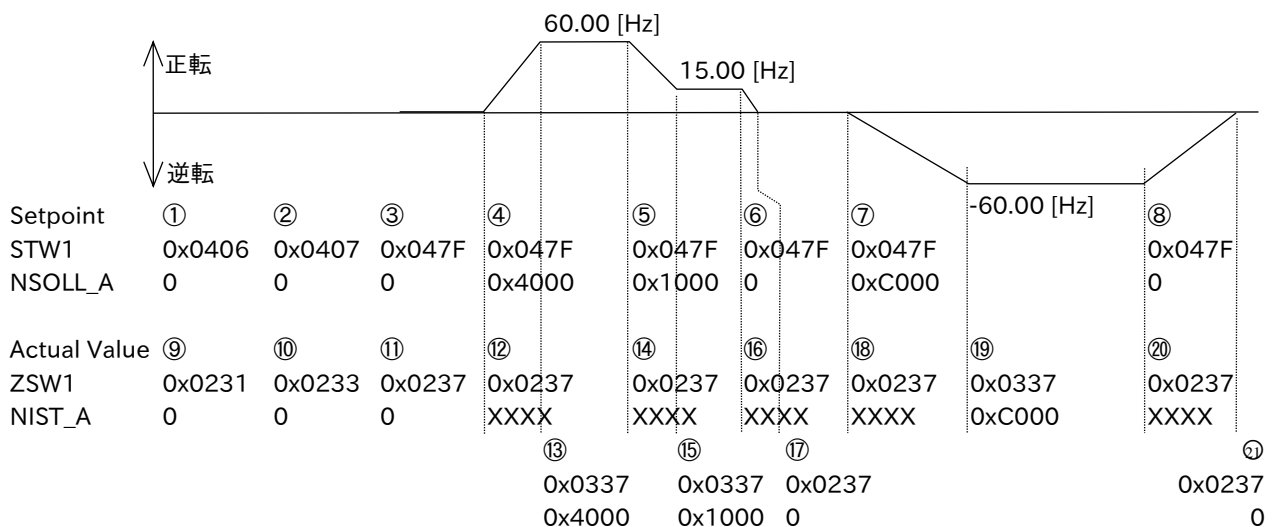

(Memo)

# Chapter 10 PNU (Parameter number)

10

## Contents

10.1 About this chapter .....	10-1
10.2 PNU (Parameter number) .....	10-2
10.3 Data types .....	10-2
10.4 Access .....	10-2
10.5 PROFIdrive area .....	10-3
10.6 Device specific area (Inverter parameter area) .....	10-9

## 10.1 About this chapter

This chapter contains information about the PNU (Parameter number).



## 10.2 PNU (Parameter number)

The parameter number is assigned to each parameter. The number range of the parameters is specified for 0 - 65535. The details are the following.

PNU	Area	Description
0 – 899	Device specific	Unused
900 – 999	For PROFIdrive	Parameters for PROFIdrive
1000 – 59999	Device specific (inverter parameter area)	These are parameters to access the parameters of SJ-P1 in P1-PN.
60000 – 60999	Reserved for PROFIdrive	Unused
61000 – 63999	Reserved for PROFIdrive (PROFINET I/O)	Unused
64000 – 65535	Reserved for PROFIdrive	Unused

## 10.3 Data types

The data types shown in the following table are used in this profile.

Data type	Code	Size	Range
Unsigned16	UINT	2 Bytes	0 to 65,535
Unsigned32	UDINT	4 Bytes	0 to 4,294,967,295
V2	V2	2 Bytes	0x0000 to 0xFFFF
Octet string	STR	–	–
Array	ARRAY	–	–

## 10.4 Access

The access methods shown in the following table are used in this profile. It indicates whether the object is read or write only, or read and write.

Access	Description
R	Read only
W	Write only
RW	Read and write

## 10.5 PROFIdrive area

## ■ 915

Sub-index	Item	Description
-	Name	Selection switch for DO IO Data in the setpoint telegram
	Data type	ARRAY of UINT
	Access	R
	Default setting	0
	Detail	This area displays oJ-01 - oJ-10 / oJ-21 - oJ-30 / oJ-41 - oJ-50 of SJ-P1 parameters.
0x00	Detail	0x0000 : STW1 The others : Modbus register No. of SJ-P1
0x01	Detail	0x0000 : NSOLL_A The others : Modbus register No. of SJ-P1
0x02 - 0x09	Detail	0x0000 : Unused The others : Modbus register No. of SJ-P1

## ■ 916

Sub-index	Item	Description
-	Name	Selection switch for DO IO Data in the actual value telegram
	Data type	ARRAY of UINT
	Access	R
	Default setting	0
	Detail	This area displays oJ-01 - oJ-10 / oJ-21 - oJ-30 / oJ-41 - oJ-50 of SJ-P1 parameters.
0x00	Detail	0x0000 : ZSW1 The others : Modbus register No. of SJ-P1
0x01	Detail	0x0000 : NIST_A The others : Modbus register No. of SJ-P1
0x02 - 0x09	Detail	0x0000 : Unused The others : Modbus register No. of SJ-P1

## ■ 922

Sub-index	Item	Description
-	Name	Telegram selection
	Data type	UINT
	Access	R
	Default setting	1
	Detail	This area displays telegram number that P1-PN is communicating. 1 : Standard telegram 1 103 : P1-PN telegram 103 104 : P1-PN telegram 104 105 : P1-PN telegram 105

## ■ 930

Sub-index	Item	Description
-	Name	Operating mode
	Data type	UINT
	Access	R
	Default setting	1
	Detail	This area displays the operating mode that P1-PN is supported. 1 : Speed control mode

## ■ 944

Sub-index	Item	Description
-	Name	Fault message counter
	Data type	UINT
	Access	R
	Default setting	0
	Detail	This area displays the number of times that the fault buffer has been changed. When the fault buffer is changed, this value is increased by 1. When you write PNU952 0, the fault buffer is cleared and this value becomes 0.

## ■ 947

Sub-index	Item	Description
0x00	Name	Fault number
-	Data type	ARRAY of UINT
0x3F	Access	R
	Default setting	0
	Detail	This area displays the fault number list that occurred in SJ-P1 and P1-PN.

## ■ 950

Sub-index	Item	Description
-	Name	Scaling of the fault buffer
	Data type	ARRAY of UINT
	Access	R
	Detail	This area displays about the fault buffer.
0x00	Name	the number of fault situation
	Default setting	8
	Detail	This area displays the number of fault situation in the fault buffer.
0x01	Name	the number of fault messages in a fault situation
	Default setting	8
	Detail	This area displays the number of fault messages in a fault situation.

## ■ 952

Sub-index	Item	Description
-	Name	Fault situation counter
	Data type	UINT
	Access	RW
	Default setting	0
	Detail	<p>This area displays the number of fault situation since power on or the last reset.</p> <p>Fault situation isn't the number of times that error occurred but the number of times that you have acknowledged errors. You can acknowledge some errors. Therefore, this value differs from the number of times that error occurred.</p> <p>[Write]</p> <p>This parameter can be written only 0.</p> <p>When you write this PNU 0, PNU944, PNU952 and PNU947 are cleared.</p>

## ■ 953

Sub-index	Item	Description
-	Name	Warning parameters
	Data type	V2
	Access	R
	Default setting	0
	Detail	<p>This area displays the warning of SJ-P1.</p> <p>This parameter is same as dE-50 of SJ-P1.</p>

## ■ 954

Sub-index	Item	Description
-	Name	Warning parameters
	Data type	V2
	Access	R
	Default setting	0
	Detail	This area displays the warning of P1-PN. Please refer to “9.9 Warning” for details.

## ■ 964

Sub-index	Item	Description
-	Name	Drive Unit identification
	Data type	ARRAY of UINT
	Access	R
	Detail	This area displays the information of P1-PN.
0x00	Name	Manufacturer
	Default setting	617
	Detail	This area displays the vendor code.
0x01	Name	Drive Unit type
	Default setting	0x0302
	Detail	This area displays drive unit type code that is the product code of P1-PN
0x02	Name	Version (Software)
	Default setting	This value depends on shipment time.
	Detail	This area displays software version of P1-PN. When version is xx.yy, this parameter is xxyy (decimal).
0x03	Name	Firmware date (year)
	Default setting	This value depends on shipment time.
	Detail	This area displays year (decimal) that firmware of P1-PN was created.
0x04	Name	Firmware date (day/month)
	Default setting	This value depends on shipment time.
	Detail	This area displays day/month (ddmm : decimal) that firmware of P1-PN was created.

## ■ 965

Sub-index	Item	Description
-	Name	Profile identification number
	Data type	STR (2 characters)
	Access	R
	Default setting	0x032A
	Detail	This area displays profile number and profile version that P1-PN supports. The 1st byte means profile number and PROFIdrive is 3. The 2nd byte means profile version. This value is 42, because P1-PN supports PROFIdrive Ver.4.2. Therefore, this value is 0x032A.

## ■ 61000

Sub-index	Item	Description
0x00	Name	NameOfStation
-	Data type	STR (0 - 240 characters)
0xEF	Access	R
	Default setting	-
	Detail	This area displays the NameOfStation of this device.

## ■ 61001

Sub-index	Item	Description
0x00	Name	IpOfStation
-	Data type	STR (4 characters)
0x03	Access	R
	Default setting	-
	Detail	This area displays the IP address of this device.

## ■ 61002

Sub-index	Item	Description
0x00	Name	MacOfStation
-	Data type	STR (6 characters)
0x05	Access	R
	Default setting	-
	Detail	This area displays the MAC address of this device.

## ■ 61003

Sub-index	Item	Description
0x00	Name	StandardGatewayOfStation
-	Data type	STR (4 characters)
0x03	Access	R
	Default setting	-
	Detail	This area displays the default gateway address of this device.

## ■ 61004

Sub-index	Item	Description
0x00	Name	SubnetMaskOfStation
-	Data type	STR (4 characters)
0x03	Access	R
	Default setting	-
	Detail	This area displays the subnet mask of this device.

## 10.6 Device specific area

### (Inverter parameter area)

Inverter parameters are allocated to objects 1003 to 1099 and 2003 to 2099. 1003 to 1099 are 2-byte parameters and 2003 to 2099 are 4-byte parameters.

PNU and Sub-index can be calculated from the Modbus register number.

$(\text{Modbus register number} / 254)$  is the Integer part after the inverter register number is divided by 254.

$(\text{Modbus register number} \% 254)$  is the remainder after the inverter register number is divided by 254.

$$\begin{aligned} \text{PNU :} & & 1000 + (\text{Modbus register number} / 254) \\ & & 2000 + (\text{Modbus register number} / 254) \\ \text{Sub-Index :} & & 1 + (\text{Modbus register number} \% 254) \end{aligned}$$

[Example] dA-01

Modbus register number = 10001

$$\begin{aligned} \text{PNU} &= 1000 + (\text{Modbus register number} / 254) \\ &= 1000 + (10001 / 254) \\ &= 1000 + 39 \\ &= 1039 \end{aligned}$$

$$\begin{aligned} \text{Sub-index} &= 1 + (\text{Modbus register number} \% 254) \\ &= 1 + (10001 \% 254) \\ &= 1 + 95 \\ &= 96 \end{aligned}$$



(Memo)

# Chapter 11 FAQ and Troubleshooting



# 11

## Contents

11.1 About this chapter.....	11-1
11.2 Self-diagnosis.....	11-2
11.3 P1-PN troubleshooting.....	11-3
11.3.1 Verify the LED .....	11-3
11.3.2 Verifying using PROFINET .....	11-5
11.3.3 Capturing packet data.....	11-6
11.4 Inverter troubleshooting .....	11-7
11.4.1 Inverter error information .....	11-7

## 11.1 About this chapter

This chapter contains the troubleshooting of cases such as errors detected by the protection function, warnings given by the warning function, or some cases in which the device is not working properly.

Symbol	Definition
	Questions about a particular situation.
	Solution/Answer
	Precautions



- When the device is not working properly or there is any trouble, first of all read this chapter. Use the following sections as a reference when dealing with these situations.

## 11.2 Self-diagnosis

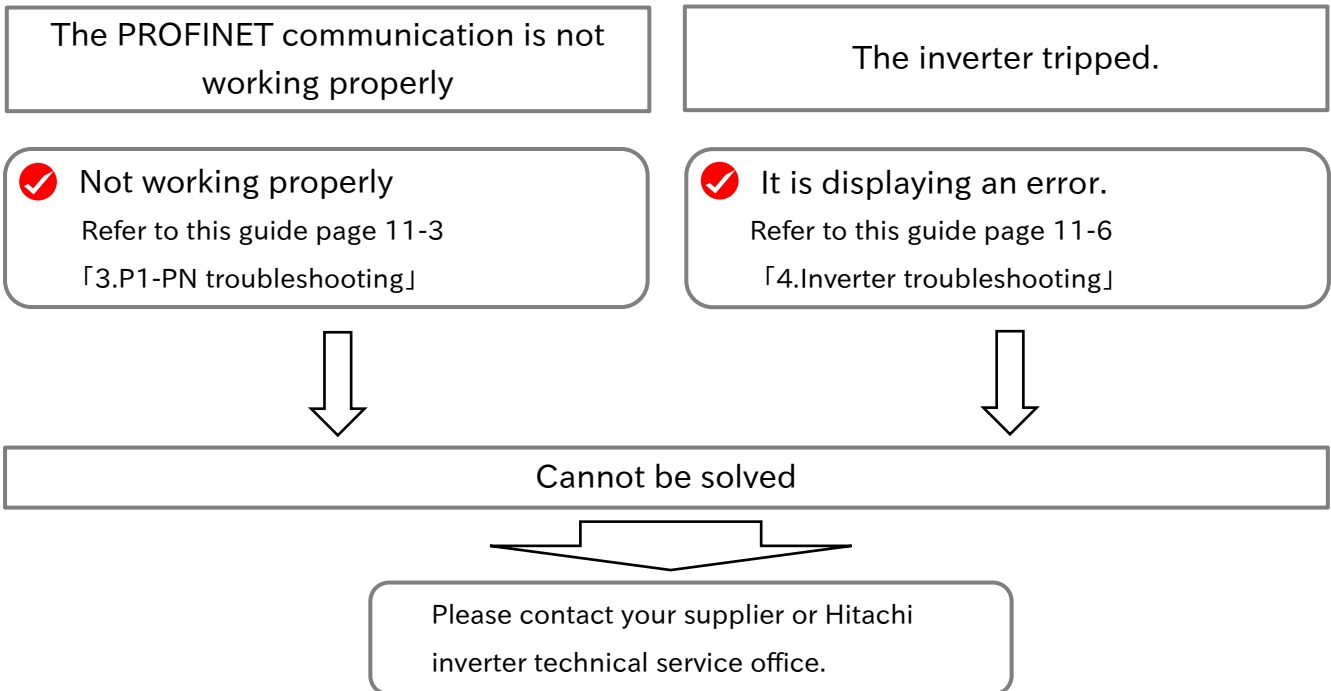

Before contacting the technical service, please confirm the items on the right.

- (1) Inverter model,
- (2) Inverter manufacture number (MFG No.),
- (3) Option device model (P1-PN),
- (4) P1-PN manufacture number (MFG No.),
- (5) Date of purchase,
- (6) Inquiry contents,

For information about how to check the inverter model and the manufacture number (MFG No.) please refer to the inverter user's manual.  
For information about how to check the P1-PN model and the manufacture number (MFG No.) please refer to the chapter 4.

Furthermore, if the inquiry is about a P1-PN communication problem please provide us with the following additional information.

- (7) Current problem or abnormality
- (8) Frequency of occurrence
- (9) The PROFINET IO controller being used
- (10) The PROFINET network configuration
- (11) Packet data when the problem occurs (if possible)

For further information regarding the communication log please refer to “11.3 P1-PN troubleshooting” .

## 11.3 P1-PN troubleshooting

### 11.3.1 Verify the LED

#### ■ LED status

abbreviation	Description · status
ON	The LED is turned ON
OFF	The LED is turned OFF
B	Blinking The LED turns ON (1[s]) and OFF (1[s]).
-	Undefined

■ Probable cause and its solution

COMM	ERR	L/A (1 / 2)	Description	Probable cause	Solution
ON	OFF	-	Communicating by the set telegram	P1-PN is communicating by the set telegram.	-
OFF	OFF	OFF	Power supply fault	The inverter power is not turned ON.	Please turn on the inverter power supply.
				The P1-PN is not correctly attached.	Turn off the inverter, then detach and attach again the P1-PN. After this, turn on the inverter again.
			P1-PN is damaged	P1-PN broke down	Please exchange the P1-PN.
OFF	-	-	PROFINET IO controller not available	P1-PN isn't connected to the PROFINET IO controller unit yet.	Check that the PROFINET IO controller unit is operating correctly.
					Check that the communications cable is connected correctly to the connector or wired correctly.
			Cable failure	The cable does not meet the required specifications.	Please exchange the cable for a cable that meets the specifications described in the section 4.2.4.
				The cable is broken.	Please exchange the cable.
Parameter fault	The parameter (NameOfStation, etc.) of P1-PN that is set in the PROFINET IO controller unit is wrong.	Check that the parameter is set in the PROFINET IO controller unit.			
OFF	B	-	Disconnection of PROFINET	The power of a PROFINET IO controller or a device on communication path is turned off.	Check the power of a PROFINET IO controller or a device on communication path.
				The cable is disconnected.	Check the cable connecting.
OFF	ON	-	P1-PN is damaged	P1-PN broke down	Please exchange the P1-PN.
B	OFF	-	Parameter is being set	P1-PN is being set parameter to from PROFINET IO controller.	Please wait, because PROFINET communication is started after parameter set is finished.
B	-	-	Flash LED	When you operate Flash LED with an engineering tool, COMM LED is blinking for 3 seconds with a frequency of 1Hz (500ms ON and 500ms OFF).	Please wait, because it takes 3 seconds to finish Flash LED.
-	-	-	Noise	There is an equipment close by that is generating noise.	Please implement measures to prevent noise.

### 11.3.2 Verifying using PROFINET

**Q**

- How do I use PROFINET to check system abnormalities.

**A**

- Inverter trips and warning notifications can be verified using ZSW1.
- In the event the inverter trips, the PROFIdrive state will shift to the Fault state. By using ZSW1 it can be checked if the state has shifted to the Fault state or not.
- In case there is an inverter warning notification, ZSW1 bit 7 will turn on.

**A**

- Any failure can be verified with PNU944, 947, and 952. Please refer to “9.9 Fault” for details.

**!**

- In case there is a PROFINET communication abnormality, if oA-12 / 22 / 32 = 0 (Error) or 1 (Trip after Deceleration stop), the status will shift to the Fault state. However, since the problem is the PROFINET communication, ZSW1 cannot be read until the communication gets restored.
- In case there are abnormalities between the inverter and the P1-PN communication, warning notifications cannot be verified.
- In case there are abnormalities between the inverter and the P1-PN communication, one of the trips between the E060, E069, E070, E079, E080 or E089 will occur.
- After the state have changed to the Fault state, it will remain in the Fault state even if the trip is restored by the trip reset. In order to change this status, perform the fault reset by turning on the bit 7 of STW1.

**!**

- PNU 944, 947, and 952 can be read by using the parameter access. In case the PROFINET IO controller can read this parameter, please refer to “9.8 parameter access” and the PROFINET IO controller manual.

### 11.3.3 Capturing packet data



- How can I capture PROFINET communication packet data.



- You can capture and analyze PROFINET communication packet data using a network protocol analyzer. It is useful to investigate the unexpected phenomenon. Recommended network protocol analyzers are the following. Please refer to each product manual about how to use them.

Product name	Manufacturer	Type
Wireshark (PC Application)	The Wireshark team	-
ET2000	Beckhoff	ET2000

## 11.4 Inverter troubleshooting

### 11.4.1 Inverter error information

#### E060 / E069

#### Option 1 Error 0 / 9

#### E070 / E079

#### Option 2 Error 0 / 9

#### E080 / E089

#### Option 3 Error 0 / 9

E060 / E069  
E070 / E079  
E080 / E089

When there is a communication error between the P1-PN and the inverter, an inverter error will occur.

In case the communication error was detected by the P1-PN, the error number will be E060, E070 or E080.

In case the communication error was detected by the inverter, the error number will be E069, E079 or E089.

The error code will depend on the slot in which the P1-PN is attached.

Issue▶	Possible cause▶	Possible solution
<p>An error occurred in the communication between the P1-PN and the inverter</p>	<ul style="list-style-type: none"> <li>· The P1-PN is not correctly attached.</li> <li>· There is an intruding object in between the P1-PN and the inverter connector</li> </ul>	<ul style="list-style-type: none"> <li>· Turn off the inverter, then detach the P1-PN and attach it again. After this, turn on the inverter again.</li> <li>· Remove the intruding object</li> </ul>



**E063****Option 1 Error 3****E073****Option 2 Error 3****E083****Option 3 Error 3****E063****E073****E083**

The P1-PN detected a PROFINET communication failure.

The error code will depend on the slot in which the P1-PN is attached.

Issue ▶	Possible cause ▶	Possible solution
There is a PROFINET communication error.	<ul style="list-style-type: none"> <li>· The PROFINET IO controller stopped.</li> </ul>	<ul style="list-style-type: none"> <li>· Verify that the PROFINET IO controller did not stop.</li> </ul>
	<ul style="list-style-type: none"> <li>· The cable got disconnected.</li> </ul>	<ul style="list-style-type: none"> <li>· Verify that the cable is connected correctly.</li> <li>· Check if the cable specification meets the required specifications. If it doesn't, please exchange the cable.</li> </ul>



---

# Chapter 12 Specifications

---

## Contents

12.1 About this chapter .....12-1  
12.2 Device specifications.....12-2

## 12.1 About this chapter

This chapter contains information about the P1-PN specifications.

## 12.2 Device specifications

### ■ Specifications

Item		Specification	
Model		P1-PN	
Weight		170g	
Environment	Ambient operating temperature	-10~50°C	No icing or condensation conditions.
	Ambient operating humidity	20~90%RH	
	Storage temperature	-20~65°C	
	Vibration resistance	5.9m/s <sup>2</sup> (0.6G)、10~55Hz	
	Conformance to EMC and electrical safety standards	IEC/EN61800-3 Second environment, Category C3 IEC/EN61800-5-1 SELV	
	Enclosure rating	IP00	
PROFINET Interface	Communications protocol	PROFINET IO Ver.2.33	
	Device type	PROFINET IO device	
	Conformance class	B	
	Protocol	DCP (Discovery and basic Configuration Protocol) LLDP (Link Layer Discovery Protocol) SNMP (Simple Network Management Protocol) MRP (Media Redundancy Protocol)	
	Netload	I	
	RT / IRT	only RT	
	Profile	PROFIdrive	
	Device ID	0x0302	
	LLDP Support TLV	chassis ID port ID Time To Live LLDP_PNIO_PORTSTATUS LLDP_PNIO_CHASSIS_MAC LLDP8023MACPHY LLDPManagement End TLV	
	SNMP Support MIB	MIB-2 LLDP-MIB LLDP-EXT-PNIO-MIB LLDP-EXT-DOT3-MIB	
	Physical layer	100BASE-TX (IEEE802.3) Auto MDI-X function is supported.	
	port	2 ports	
	MAC address	3 (Host, Port 1 / 2)	
	Cable	100BX-TX support (category 5e or higher) STP(Shield twist pair) cable (Straight or Crossed).	
	Communication speed	Auto negotiation. However, 100BASE-TX full duplex (IEEE802.3) only	
	Communication distance	Distance between nodes(between devices): 100[m]max	

	Item	Specification
PROFIdrive	PROFIdrive version	4.2
	Application class	AC1 (Standard Drive)
	Telegram	Standard telegram 1 P1-PN telegram 103 (PPO3 of PROFIdrive version 2) P1-PN telegram 104 (PPO4 of PROFIdrive version 2) P1-PN telegram 105 (like PPO5 of PROFIdrive version 2)
	Configuring of telegram	oH-24 and From oJ-01 to oJ-60 of SJ-P1 parameters
	Operating mode	Speed control mode
	Jogging	Only jogging 1 is supported.

(Memo)

## 13

# Chapter 13 Parameter List

## Contents

13.1 About this chapter .....	13-1
13.2 Parameter list.....	13-2
13.2.1 Code-d.....	13-2
13.2.2 Code-F.....	13-19
13.2.3 Code-A.....	13-19
13.2.4 Code-b.....	13-38
13.2.5 Code-C .....	13-47
13.2.6 Code-H .....	13-60
13.2.7 Code-o.....	13-71
13.2.8 Code-P.....	13-85
13.2.9 Code-U .....	13-86
13.2.10 Others.....	13-95

## 13.1 About this chapter

This chapter contains the list of PNU and Sub-index of inverter parameter.

## 13.2 Parameter list

This is the list of parameters of SJ-P1 Ver.2.00.  
Please check the user's guide of inverter about the parameters that are added later than Ver.2.00.  
For PNU and Sub-index of the parameters that are added later than Ver.2.00, please calculate that yourself, because PNU and Sub-index can be calculated from the modbus register number.  
Please refer to “10.6 Inverter parameter area “ for details.

For information about the PROFIdrive area, please refer to the chapter 10 “PNU (Parameter number)” .

### ■ Items on the List

Item	Description
PNU	Parameter number Necessary when accessing the parameter through PROFINET.
Sub-index	PNU sub-index. Necessary when accessing the parameter through PROFINET.
Func code	Parameter function code.
Function name	Parameter name.
Type	Parameter type UINT : (16 bits) UDINT : (32 bits)
Access	R : Read only W : Write only RW : Read-Write
Setting Items	Range of Values
Data resolution·units	Resolution and units

### 13.2.1 Code-d

Index	Sub-index	Func code	Function name	Type	Access	Setting Items	Data resolution·units
1039	0x60	dA-01	Output frequency monitor	UINT	R	0 ~ 59000	0.01Hz
1039	0x61	dA-02	Output current monitor	UINT	R	0 ~ 65535	0.01A
1039	0x62	dA-03	Rotation direction monitor	UINT	R	0 ~ 3	1
2039	0x63	dA-04	Frequency reference monitor(After calculation)	UDINT	R	-59000 ~ 59000	0.01Hz

Index	Sub-index	Func code	Function name	Type	Access	Setting Items	Data resolution· units
2039	0x65	dA-06	Output frequency scale conversion monitor	UDINT	R	0 ~ 5900000	0.01
2039	0x67	dA-08	Detect speed monitor	UDINT	R	-59000 ~ 59000	0.01Hz
2039	0x6B	dA-12	Output frequency (+/-)	UDINT	R	-59000 ~ 59000	0.01Hz
1039	0x6D	dA-14	Frequency upper limit monitor	UINT	R	0 ~ 59000	0.01Hz
1039	0x6E	dA-15	Torque reference monitor(After calculation)	UINT	R	-10000 ~ 10000	0.1%
1039	0x6F	dA-16	Torque limit monitor	UINT	R	0 ~ 5000	0.1%
1039	0x70	dA-17	Output Torque monitor	UINT	R	-10000 ~ 10000	0.1%
1039	0x71	dA-18	Output Voltage monitor	UINT	R	0 ~ 8000	0.1v
2039	0x73	dA-20	Current position monitor	UDINT	R	-268435455 ~ 268435455 High resolution mode : -1073741823 ~ 1073741823	1pls
2039	0x79	dA-26	Pulse train position deviation monitor	UDINT	R	-2147483647 ~ 2147483647	1pls
2039	0x7B	dA-28	Pulse counter monitor	UDINT	R	0 ~ 2147483647	1pls
1039	0x7D	dA-30	Input power monitor	UINT	R	0 ~ 60000 (~132kW) 0~20000 (160kW~)	0.01kWh 0.1kWh
2039	0x7F	dA-32	Accumulation input power monitor	UDINT	R	0 ~ 10000000	0.1kWh
1039	0x81	dA-34	Output power monitor	UINT	R	0 ~ 60000 (~132kW) 0~20000 (160kW~)	0.01kWh 0.1kWh
2039	0x83	dA-36	Accumulation output power monitor	UDINT	R	0 ~ 10000000	0.1kWh
1039	0x85	dA-38	Motor temperature monitor	UINT	R	-200 ~ 2000	0.1℃
1039	0x87	dA-40	DC-bus voltage monitor	UINT	R	0 ~ 10000	0.1Vdc
1039	0x88	dA-41	BRD Load rating monitor	UINT	R	0 ~ 10000	0.01%
1039	0x89	dA-42	Electronic thermal Load rating monitor (MTR)	UINT	R	0 ~ 10000	0.01%
1039	0x8A	dA-43	Electronic thermal Load rating monitor (CTL)	UINT	R	0 ~ 10000	0.01%



Index	Sub-index	Func code	Function name	Type	Access	Setting Items	Data resolution· units
1039	0x8C	dA-45	Safety STO monitor	UINT	R	0 ~ 7	1
1039	0x8D	dA-46	Safety option hardware monitor	UINT	R	0 ~ 0xFFFF	1
1039	0x8E	dA-47	Safety option monitor	UINT	R	0 ~ 6	1
1039	0x91	dA-50	Control terminal status	UINT	R	0 ~ 15	1
1039	0x92	dA-51	Input terminal monitor	UINT	R	0 ~ 0xFFFF	1
1039	0x95	dA-54	Output terminal monitor	UINT	R	0 ~ 0xFF	1
1039	0x9B	dA-60	Analog input/output status monitor	UINT	R	0 ~ 0xFF	1
1039	0x9C	dA-61	Analog input Ai1 monitor	UINT	R	0 ~ 10000	0.01%
1039	0x9D	dA-62	Analog input Ai2 monitor	UINT	R	0 ~ 10000	0.01%
1039	0x9E	dA-63	Analog input Ai3 monitor	UINT	R	-10000 ~ 10000	0.01%
1039	0x9F	dA-64	Extension Analog input [Ai4] monitor	UINT	R	0 ~ 10000	0.01%
1039	0xA0	dA-65	Extension Analog input [Ai5] monitor	UINT	R	0 ~ 10000	0.01%
1039	0xA1	dA-66	Extension Analog input [Ai6] monitor	UINT	R	-10000 ~ 10000	0.01%
1039	0xA5	dA-70	Pulse train input monitor (internal)	UINT	R	-10000 ~ 10000	0.01%
1039	0xA6	dA-71	Pulse train input monitor (Option)	UINT	R	-10000 ~ 10000	0.01%
1039	0xB0	dA-81	Option slot-1 status	UINT	R	0 ~ 48	1
1039	0xB1	dA-82	Option slot-2 status	UINT	R	0 ~ 48	1
1039	0xB2	dA-83	Option slot-3 status	UINT	R	0 ~ 48	1
1039	0xC4	db-01	Program download monitor	UINT	R	0 ~ 1	1
1039	0xC5	db-02	Program No. monitor	UINT	R	0 ~ 9999	1
1039	0xC6	db-03	Program counter (Task-1)	UINT	R	1 ~ 1024	1
1039	0xC7	db-04	Program counter (Task-2)	UINT	R	1 ~ 1024	1
1039	0xC8	db-05	Program counter (Task-3)	UINT	R	1 ~ 1024	1
1039	0xC9	db-06	Program counter (Task-4)	UINT	R	1 ~ 1024	1

Index	Sub-index	Func code	Function name	Type	Access	Setting Items	Data resolution· units
1039	0xCA	db-07	Program counter (Task-5)	UINT	R	1 ~ 1024	1
2039	0xCB	db-08	User monitor-0	UDINT	R	-2147483647 ~ 2147483647	1
2039	0xCD	db-10	User monitor-1	UDINT	R	-2147483647 ~ 2147483647	1
2039	0xCF	db-12	User monitor-2	UDINT	R	-2147483647 ~ 2147483647	1
2039	0xD1	db-14	User monitor-3	UDINT	R	-2147483647 ~ 2147483647	1
2039	0xD3	db-16	User monitor-4	UDINT	R	-2147483647 ~ 2147483647	1
1039	0xD5	db-18	Analog output monitor YA0	UINT	R	0 ~ 10000	0.01%
1039	0xD6	db-19	Analog output monitor YA1	UINT	R	0 ~ 10000	0.01%
1039	0xD7	db-20	Analog output monitor YA2	UINT	R	0 ~ 10000	0.01%
1039	0xD8	db-21	Analog output monitor YA3	UINT	R	0 ~ 10000	0.01%
1039	0xD9	db-22	Analog output monitor YA4	UINT	R	0 ~ 10000	0.01%
1039	0xDA	db-23	Analog output monitor YA5	UINT	R	0 ~ 10000	0.01%
2039	0xE1	db-30	PID1 Feedback value 1 monitor	UDINT	R	-10000 ~ 10000	Depends on AH-06
2039	0xE3	db-32	PID1 Feedback value 2 monitor	UDINT	R	-10000 ~ 10000	Depends on AH-06
2039	0xE5	db-34	PID1 Feedback value 3 monitor	UDINT	R	-10000 ~ 10000	Depends on AH-06
2039	0xE7	db-36	PID2 Feedback value monitor	UDINT	R	-10000 ~ 10000	Depends on AJ-06
2039	0xE9	db-38	PID3 Feedback value monitor	UDINT	R	-10000 ~ 10000	Depends on AJ-26
2039	0xEB	db-40	PID4 Feedback value monitor	UDINT	R	-10000 ~ 10000	Depends on AJ-46
2039	0xED	db-42	PID1 SV	UDINT	R	-10000 ~ 10000	Depends on AH-06
2039	0xEF	db-44	PID1 PV	UDINT	R	-10000 ~ 10000	Depends on AH-06
1039	0xF5	db-50	PID1 Output monitor	UINT	R	-10000 ~ 10000	0.01%
1039	0xF6	db-51	PID1 Deviation monitor	UINT	R	-10000 ~ 10000	0.01%
1039	0xF7	db-52	PID1 Deviation 1 monitor	UINT	R	-10000 ~ 10000	0.01%
1039	0xF8	db-53	PID1 Deviation 2 monitor	UINT	R	-10000 ~ 10000	0.01%
1039	0xF9	db-54	PID1 Deviation 3 monitor	UINT	R	-10000 ~ 10000	0.01%
1039	0xFA	db-55	PID2 Output monitor	UINT	R	-10000 ~ 10000	0.01%
1039	0xFB	db-56	PID2 Deviation monitor	UINT	R	-10000 ~ 10000	0.01%
1039	0xFC	db-57	PID3 Output monitor	UINT	R	-10000 ~ 10000	0.01%
1039	0xFD	db-58	PID3 Deviation monitor	UINT	R	-10000 ~ 10000	0.01%

Index	Sub-index	Func code	Function name	Type	Access	Setting Items	Data resolution· units
1039	0xFE	db-59	PID4 Output monitor	UINT	R	-10000 ~ 10000	0.01%
1040	0x1	db-60	PID4 Deviation monitor	UINT	R	-10000 ~ 10000	0.01%
1040	0x2	db-61	Current PID P-Gain monitor	UINT	R	0 ~ 1000	0.1 times
1040	0x3	db-62	Current PID I-Gain monitor	UINT	R	0 ~ 36000	0.1s
1040	0x4	db-63	Current PID D-Gain monitor	UINT	R	0 ~ 10000	0.01s
1040	0x5	db-64	PID FeedForward monitor	UINT	R	0 ~ 10000	0.01%
1040	0x2A	dC-01	Inverter Load type status	UINT	R	0 ~ 2	1
1040	0x2B	dC-02	Rated current monitor	UINT	R	0 ~ 65535	0.1a
1040	0x30	dC-07	Main speed input source monitor	UINT	R	0 ~ 34	1
1040	0x31	dC-08	Sub speed input source monitor	UINT	R	0 ~ 34	1
1040	0x33	dC-10	RUN command input source monitor	UINT	R	0 ~ 6	1
1040	0x38	dC-15	Cooling-fin temperature monitor	UINT	R	-200 ~ 2000	0.1°C
1040	0x39	dC-16	Life assessment monitor	UINT	R	0 ~ 0xFF	1
1040	0x3D	dC-20	Accumulation Start number monitor	UINT	R	1 ~ 65535	1
1040	0x3E	dC-21	Accumulation Power-on number monitor	UINT	R	1 ~ 65535	1
2040	0x3F	dC-22	Accumulated time monitor in RUN status monitor	UDINT	R	0 ~ 1000000	1hr
2040	0x41	dC-24	Accumulation power-on time monitor	UDINT	R	0 ~ 1000000	1hr
2040	0x43	dC-26	Cooling fan accumulation running time monitor	UDINT	R	0 ~ 1000000	1hr
1040	0x4E	dC-37	Icon2 LIM monitor	UINT	R	0 ~ 6	1
1040	0x4F	dC-38	Icon2 ALT monitor	UINT	R	0 ~ 4	1
1040	0x50	dC-39	Icon2 RETRY monitor	UINT	R	0 ~ 2	1
1040	0x51	dC-40	Icon2 NRDY monitor	UINT	R	0 ~ 9	1

Index	Sub-index	Func code	Function name	Type	Access	Setting Items	Data resolution· units
1040	0x56	dC-45	IM/SM monitor	UINT	R	0 ~ 1	1
1040	0x5B	dC-50	Firmware Ver. Monitor	UINT	R	0 ~ 0xFFFF Top byte : Major Low Byte : Minor	1
1040	0x5E	dC-53	Firmware Gr.	UINT	R	0 ~ 1	1
1040	0xF2	dE-01	Trip number monitor	UINT	R	0 ~ 65535	1
1003	0xF0	dE-11	Trip monitor 1 Factor	UINT	R	1 ~ 255	1
2003	0xF1	dE-11	Trip monitor 1 Output frequency (+/-)	UDINT	R	-59000 ~ 59000	0.01Hz
1003	0xF3	dE-11	Trip monitor 1 Output current	UINT	R	0 ~ 65535	0.01A
1003	0xF4	dE-11	Trip monitor 1 DC-bus voltage	UINT	R	0 ~ 10000	0.1Vdc
1003	0xF5	dE-11	Trip monitor 1 Inverter status	UINT	R	0 ~ 8	1
1003	0xF6	dE-11	Trip monitor 1 LAD status	UINT	R	0 ~ 5	1
1003	0xF7	dE-11	Trip monitor 1 Control mode	UINT	R	0 ~ 11	1
1003	0xF8	dE-11	Trip monitor 1 Limit status	UINT	R	0 ~ 6	1
1003	0xF9	dE-11	Trip monitor 1 Specific status	UINT	R	0 ~ 6	1
2003	0xFB	dE-11	Trip monitor 1 Running time	UDINT	R	0 ~ 1000000	1hr
2003	0xFD	dE-11	Trip monitor 1 Power-on time	UDINT	R	0 ~ 1000000	1hr
1004	0x1	dE-11	Trip monitor 1 Time (Year/Month)	UINT	R	00 ~ 99 (BCD code) 01 ~ 12 (BCD code)	1 1
1004	0x2	dE-11	Trip monitor 1 Time (Day)	UINT	R	01 ~ 31 (BCD code) 00 ~ 06 (BCD code)	1 1
1004	0x3	dE-11	Trip monitor 1 Time (Hour/Minute)	UINT	R	00 ~ 23 (BCD code) 00 ~ 59 (BCD code)	1 1
1004	0x6	dE-12	Trip monitor 2 Factor	UINT	R	1 ~ 255	1
2004	0x7	dE-12	Trip monitor 2 Output frequency (+/-)	UDINT	R	-59000 ~ 59000	0.01Hz
1004	0x9	dE-12	Trip monitor 2 Output current	UINT	R	0 ~ 65535	0.01A
1004	0xA	dE-12	Trip monitor 2 DC-bus voltage	UINT	R	0 ~ 10000	0.1Vdc
1004	0xB	dE-12	Trip monitor 2 Inverter status	UINT	R	0 ~ 8	1
1004	0xC	dE-12	Trip monitor 2 LAD status	UINT	R	0 ~ 5	1
1004	0xD	dE-12	Trip monitor 2 Control mode	UINT	R	0 ~ 11	1

Index	Sub-index	Func code	Function name	Type	Access	Setting Items	Data resolution· units
1004	0xE	dE-12	Trip monitor 2 Limit status	UINT	R	0 ~ 6	1
1004	0xF	dE-12	Trip monitor 2 Specific status	UINT	R	0 ~ 6	1
2004	0x11	dE-12	Trip monitor 2 Running time	UDINT	R	0 ~ 1000000	1hr
2004	0x13	dE-12	Trip monitor 2 Power-on time	UDINT	R	0 ~ 1000000	1hr
1004	0x15	dE-12	Trip monitor 2 Time (Year/Month)	UINT	R	00 ~ 99 (BCD code) 01 ~ 12 (BCD code)	1 1
1004	0x16	dE-12	Trip monitor 2 Time (Day)	UINT	R	01 ~ 31 (BCD code) 00 ~ 06 (BCD code)	1 1
1004	0x17	dE-12	Trip monitor 2 Time (Hour/Minute)	UINT	R	00 ~ 23 (BCD code) 00 ~ 59 (BCD code)	1 1
1004	0x1A	dE-13	Trip monitor 3 Factor	UINT	R	1 ~ 255	1
2004	0x1B	dE-13	Trip monitor 3 Output frequency (+/-)	UDINT	R	-59000 ~ 59000	0.01Hz
1004	0x1D	dE-13	Trip monitor 3 Output current	UINT	R	0 ~ 65535	0.01A
1004	0x1E	dE-13	Trip monitor 3 DC-bus voltage	UINT	R	0 ~ 10000	0.1Vdc
1004	0x1F	dE-13	Trip monitor 3 Inverter status	UINT	R	0 ~ 8	1
1004	0x20	dE-13	Trip monitor 3 LAD status	UINT	R	0 ~ 5	1
1004	0x21	dE-13	Trip monitor 3 Control mode	UINT	R	0 ~ 11	1
1004	0x22	dE-13	Trip monitor 3 Limit status	UINT	R	0 ~ 6	1
1004	0x23	dE-13	Trip monitor 3 Specific status	UINT	R	0 ~ 6	1
2004	0x25	dE-13	Trip monitor 3 Running time	UDINT	R	0 ~ 1000000	1hr
2004	0x27	dE-13	Trip monitor 3 Power-on time	UDINT	R	0 ~ 1000000	1hr
1004	0x29	dE-13	Trip monitor 3 Time (Year/Month)	UINT	R	00 ~ 99 (BCD code) 01 ~ 12 (BCD code)	1 1
1004	0x2A	dE-13	Trip monitor 3 Time (Day)	UINT	R	01 ~ 31 (BCD code) 00 ~ 06 (BCD code)	1 1
1004	0x2B	dE-13	Trip monitor 3 Time (Hour/Minute)	UINT	R	00 ~ 23 (BCD code) 00 ~ 59 (BCD code)	1 1
1004	0x2E	dE-14	Trip monitor 4 Factor	UINT	R	1 ~ 255	1
2004	0x2F	dE-14	Trip monitor 4 Output frequency (+/-)	UDINT	R	-59000 ~ 59000	0.01Hz
1004	0x31	dE-14	Trip monitor 4 Output current	UINT	R	0 ~ 65535	0.01A

Index	Sub-index	Func code	Function name	Type	Access	Setting Items	Data resolution· units
1004	0x32	dE-14	Trip monitor 4 DC-bus voltage	UINT	R	0 ~ 10000	0.1Vdc
1004	0x33	dE-14	Trip monitor 4 Inverter status	UINT	R	0 ~ 8	1
1004	0x34	dE-14	Trip monitor 4 LAD status	UINT	R	0 ~ 5	1
1004	0x35	dE-14	Trip monitor 4 Control mode	UINT	R	0 ~ 11	1
1004	0x36	dE-14	Trip monitor 4 Limit status	UINT	R	0 ~ 6	1
1004	0x37	dE-14	Trip monitor 4 Specific status	UINT	R	0 ~ 6	1
2004	0x39	dE-14	Trip monitor 4 Running time	UDINT	R	0 ~ 1000000	1hr
2004	0x3B	dE-14	Trip monitor 4 Power-on time	UDINT	R	0 ~ 1000000	1hr
1004	0x3D	dE-14	Trip monitor 4 Time (Year/Month)	UINT	R	00 ~ 99 (BCD code) 01 ~ 12 (BCD code)	1 1
1004	0x3E	dE-14	Trip monitor 4 Time (Day)	UINT	R	01 ~ 31 (BCD code) 00 ~ 06 (BCD code)	1 1
1004	0x3F	dE-14	Trip monitor 4 Time (Hour/Minute)	UINT	R	00 ~ 23 (BCD code) 00 ~ 59 (BCD code)	1 1
1004	0x42	dE-15	Trip monitor 5 Factor	UINT	R	1 ~ 255	1
2004	0x43	dE-15	Trip monitor 5 Output frequency (+/-)	UDINT	R	-59000 ~ 59000	0.01Hz
1004	0x45	dE-15	Trip monitor 5 Output current	UINT	R	0 ~ 65535	0.01A
1004	0x46	dE-15	Trip monitor 5 DC-bus voltage	UINT	R	0 ~ 10000	0.1Vdc
1004	0x47	dE-15	Trip monitor 5 Inverter status	UINT	R	0 ~ 8	1
1004	0x48	dE-15	Trip monitor 5 LAD status	UINT	R	0 ~ 5	1
1004	0x49	dE-15	Trip monitor 5 Control mode	UINT	R	0 ~ 11	1
1004	0x4A	dE-15	Trip monitor 5 Limit status	UINT	R	0 ~ 6	1
1004	0x4B	dE-15	Trip monitor 5 Specific status	UINT	R	0 ~ 6	1
2004	0x4D	dE-15	Trip monitor 5 Running time	UDINT	R	0 ~ 1000000	1hr
2004	0x4F	dE-15	Trip monitor 5 Power-on time	UDINT	R	0 ~ 1000000	1hr
1004	0x51	dE-15	Trip monitor 5 Time (Year/Month)	UINT	R	00 ~ 99 (BCD code) 01 ~ 12 (BCD code)	1 1
1004	0x52	dE-15	Trip monitor 5 Time (Day)	UINT	R	01 ~ 31 (BCD code) 00 ~ 06 (BCD code)	1 1

Index	Sub-index	Func code	Function name	Type	Access	Setting Items	Data resolution· units
1004	0x53	dE-15	Trip monitor 5 Time (Hour/Minute)	UINT	R	00 ~ 23 (BCD code) 00 ~ 59 (BCD code)	1 1
1004	0x56	dE-16	Trip monitor 6 Factor	UINT	R	1 ~ 255	1
2004	0x57	dE-16	Trip monitor 6 Output frequency (+/-)	UDINT	R	-59000 ~ 59000	0.01Hz
1004	0x59	dE-16	Trip monitor 6 Output current	UINT	R	0 ~ 65535	0.01A
1004	0x5A	dE-16	Trip monitor 6 DC-bus voltage	UINT	R	0 ~ 10000	0.1Vdc
1004	0x5B	dE-16	Trip monitor 6 Inverter status	UINT	R	0 ~ 8	1
1004	0x5C	dE-16	Trip monitor 6 LAD status	UINT	R	0 ~ 5	1
1004	0x5D	dE-16	Trip monitor 6 Control mode	UINT	R	0 ~ 11	1
1004	0x5E	dE-16	Trip monitor 6 Limit status	UINT	R	0 ~ 6	1
1004	0x5F	dE-16	Trip monitor 6 Specific status	UINT	R	0 ~ 6	1
2004	0x61	dE-16	Trip monitor 6 Running time	UDINT	R	0 ~ 1000000	1hr
2004	0x63	dE-16	Trip monitor 6 Power-on time	UDINT	R	0 ~ 1000000	1hr
1004	0x65	dE-16	Trip monitor 6 Time (Year/Month)	UINT	R	00 ~ 99 (BCD code) 01 ~ 12 (BCD code)	1 1
1004	0x66	dE-16	Trip monitor 6 Time (Day)	UINT	R	01 ~ 31 (BCD code) 00 ~ 06 (BCD code)	1 1
1004	0x67	dE-16	Trip monitor 6 Time (Hour/Minute)	UINT	R	00 ~ 23 (BCD code) 00 ~ 59 (BCD code)	1 1
1004	0x6A	dE-17	Trip monitor 7 Factor	UINT	R	1 ~ 255	1
2004	0x6B	dE-17	Trip monitor 7 Output frequency (+/-)	UDINT	R	-59000 ~ 59000	0.01Hz
1004	0x6D	dE-17	Trip monitor 7 Output current	UINT	R	0 ~ 65535	0.01A
1004	0x6E	dE-17	Trip monitor 7 DC-bus voltage	UINT	R	0 ~ 10000	0.1Vdc
1004	0x6F	dE-17	Trip monitor 7 Inverter status	UINT	R	0 ~ 8	1
1004	0x70	dE-17	Trip monitor 7 LAD status	UINT	R	0 ~ 5	1
1004	0x71	dE-17	Trip monitor 7 Control mode	UINT	R	0 ~ 11	1
1004	0x72	dE-17	Trip monitor 7 Limit status	UINT	R	0 ~ 6	1
1004	0x73	dE-17	Trip monitor 7 Specific status	UINT	R	0 ~ 6	1

Index	Sub-index	Func code	Function name	Type	Access	Setting Items	Data resolution· units
2004	0x75	dE-17	Trip monitor 7 Running time	UDINT	R	0 ~ 1000000	1hr
2004	0x77	dE-17	Trip monitor 7 Power-on time	UDINT	R	0 ~ 1000000	1hr
1004	0x79	dE-17	Trip monitor 7 Time (Year/Month)	UINT	R	00 ~ 99 (BCD code) 01 ~ 12 (BCD code)	1 1
1004	0x7A	dE-17	Trip monitor 7 Time (Day)	UINT	R	01 ~ 31 (BCD code) 00 ~ 06 (BCD code)	1 1
1004	0x7B	dE-17	Trip monitor 7 Time (Hour/Minute)	UINT	R	00 ~ 23 (BCD code) 00 ~ 59 (BCD code)	1 1
1004	0x7E	dE-18	Trip monitor 8 Factor	UINT	R	1 ~ 255	1
2004	0x7F	dE-18	Trip monitor 8 Output frequency (+/-)	UDINT	R	-59000 ~ 59000	0.01Hz
1004	0x81	dE-18	Trip monitor 8 Output current	UINT	R	0 ~ 65535	0.01A
1004	0x82	dE-18	Trip monitor 8 DC-bus voltage	UINT	R	0 ~ 10000	0.1Vdc
1004	0x83	dE-18	Trip monitor 8 Inverter status	UINT	R	0 ~ 8	1
1004	0x84	dE-18	Trip monitor 8 LAD status	UINT	R	0 ~ 5	1
1004	0x85	dE-18	Trip monitor 8 Control mode	UINT	R	0 ~ 11	1
1004	0x86	dE-18	Trip monitor 8 Limit status	UINT	R	0 ~ 6	1
1004	0x87	dE-18	Trip monitor 8 Specific status	UINT	R	0 ~ 6	1
2004	0x89	dE-18	Trip monitor 8 Running time	UDINT	R	0 ~ 1000000	1hr
2004	0x8B	dE-18	Trip monitor 8 Power-on time	UDINT	R	0 ~ 1000000	1hr
1004	0x8D	dE-18	Trip monitor 8 Time (Year/Month)	UINT	R	00 ~ 99 (BCD code) 01 ~ 12 (BCD code)	1 1
1004	0x8E	dE-18	Trip monitor 8 Time (Day)	UINT	R	01 ~ 31 (BCD code) 00 ~ 06 (BCD code)	1 1
1004	0x8F	dE-18	Trip monitor 8 Time (Hour/Minute)	UINT	R	00 ~ 23 (BCD code) 00 ~ 59 (BCD code)	1 1
1004	0x92	dE-19	Trip monitor 9 Factor	UINT	R	1 ~ 255	1
2004	0x93	dE-19	Trip monitor 9 Output frequency (+/-)	UDINT	R	-59000 ~ 59000	0.01Hz
1004	0x95	dE-19	Trip monitor 9 Output current	UINT	R	0 ~ 65535	0.01A
1004	0x96	dE-19	Trip monitor 9 DC-bus voltage	UINT	R	0 ~ 10000	0.1Vdc
1004	0x97	dE-19	Trip monitor 9 Inverter status	UINT	R	0 ~ 8	1



Index	Sub-index	Func code	Function name	Type	Access	Setting Items	Data resolution· units
1004	0x98	dE-19	Trip monitor 9 LAD status	UINT	R	0 ~ 5	1
1004	0x99	dE-19	Trip monitor 9 Control mode	UINT	R	0 ~ 11	1
1004	0x9A	dE-19	Trip monitor 9 Limit status	UINT	R	0 ~ 6	1
1004	0x9B	dE-19	Trip monitor 9 Specific status	UINT	R	0 ~ 6	1
2004	0x9D	dE-19	Trip monitor 9 Running time	UDINT	R	0 ~ 1000000	1hr
2004	0x9F	dE-19	Trip monitor 9 Power-on time	UDINT	R	0 ~ 1000000	1hr
1004	0xA1	dE-19	Trip monitor 9 Time (Year/Month)	UINT	R	00 ~ 99 (BCD code) 01 ~ 12 (BCD code)	1 1
1004	0xA2	dE-19	Trip monitor 9 Time (Day)	UINT	R	01 ~ 31 (BCD code) 00 ~ 06 (BCD code)	1 1
1004	0xA3	dE-19	Trip monitor 9 Time (Hour/Minute)	UINT	R	00 ~ 23 (BCD code) 00 ~ 59 (BCD code)	1 1
1004	0xA6	dE-20	Trip monitor 10 Factor	UINT	R	1 ~ 255	1
2004	0xA7	dE-20	Trip monitor 10 Output frequency (+/-)	UDINT	R	-59000 ~ 59000	0.01Hz
1004	0xA9	dE-20	Trip monitor 10 Output current	UINT	R	0 ~ 65535	0.01A
1004	0xAA	dE-20	Trip monitor 10 DC-bus voltage	UINT	R	0 ~ 10000	0.1Vdc
1004	0xAB	dE-20	Trip monitor 10 Inverter status	UINT	R	0 ~ 8	1
1004	0xAC	dE-20	Trip monitor 10 LAD status	UINT	R	0 ~ 5	1
1004	0xAD	dE-20	Trip monitor 10 Control mode	UINT	R	0 ~ 11	1
1004	0xAE	dE-20	Trip monitor 10 Limit status	UINT	R	0 ~ 6	1
1004	0xAF	dE-20	Trip monitor 10 Specific status	UINT	R	0 ~ 6	1
2004	0xB1	dE-20	Trip monitor 10 Running time	UDINT	R	0 ~ 1000000	1hr
2004	0xB3	dE-20	Trip monitor 10 Power-on time	UDINT	R	0 ~ 1000000	1hr
1004	0xB5	dE-20	Trip monitor 10 Time (Year/Month)	UINT	R	00 ~ 99 (BCD code) 01 ~ 12 (BCD code)	1 1
1004	0xB6	dE-20	Trip monitor 10 Time (Day)	UINT	R	01 ~ 31 (BCD code) 00 ~ 06 (BCD code)	1 1
1004	0xB7	dE-20	Trip monitor 10 Time (Hour/Minute)	UINT	R	00 ~ 23 (BCD code) 00 ~ 59 (BCD code)	1 1
1004	0xBA	dE-31	Retry monitor 1 Factor	UINT	R	1 ~ 255	1

Index	Sub-index	Func code	Function name	Type	Access	Setting Items	Data resolution· units
2004	0xBB	dE-31	Retry monitor 1 Output frequency (+/-)	UDINT	R	-59000 ~ 59000	0.01Hz
1004	0xBD	dE-31	Retry monitor 1 Output current	UINT	R	0 ~ 65535	0.01A
1004	0xBE	dE-31	Retry monitor 1 DC-bus voltage	UINT	R	0 ~ 10000	0.1Vdc
1004	0xBF	dE-31	Retry monitor 1 Inverter status	UINT	R	0 ~ 8	1
1004	0xC0	dE-31	Retry monitor 1 LAD status	UINT	R	0 ~ 5	1
1004	0xC1	dE-31	Retry monitor 1 Control mode	UINT	R	0 ~ 11	1
1004	0xC2	dE-31	Retry monitor 1 Limit status	UINT	R	0 ~ 6	1
1004	0xC3	dE-31	Retry monitor 1 Specific status	UINT	R	0 ~ 6	1
2004	0xC5	dE-31	Retry monitor 1 Running time	UDINT	R	0 ~ 1000000	1hr
2004	0xC7	dE-31	Retry monitor 1 Power-on time	UDINT	R	0 ~ 1000000	1hr
1004	0xC9	dE-31	Retry monitor 1 Time (Year/Month)	UINT	R	00 ~ 99 (BCD code) 01 ~ 12 (BCD code)	1 1
1004	0xCA	dE-31	Retry monitor 1 Time (Day)	UINT	R	01 ~ 31 (BCD code) 00 ~ 06 (BCD code)	1 1
1004	0xCB	dE-31	Retry monitor 1 Time (Hour/Minute)	UINT	R	00 ~ 23 (BCD code) 00 ~ 59 (BCD code)	1 1
1004	0xCE	dE-32	Retry monitor 2 Factor	UINT	R	1 ~ 255	1
2004	0xCF	dE-32	Retry monitor 2 Output frequency (+/-)	UDINT	R	-59000 ~ 59000	0.01Hz
1004	0xD1	dE-32	Retry monitor 2 Output current	UINT	R	0 ~ 65535	0.01A
1004	0xD2	dE-32	Retry monitor 2 DC-bus voltage	UINT	R	0 ~ 10000	0.1Vdc
1004	0xD3	dE-32	Retry monitor 2 Inverter status	UINT	R	0 ~ 8	1
1004	0xD4	dE-32	Retry monitor 2 LAD status	UINT	R	0 ~ 5	1
1004	0xD5	dE-32	Retry monitor 2 Control mode	UINT	R	0 ~ 11	1
1004	0xD6	dE-32	Retry monitor 2 Limit status	UINT	R	0 ~ 6	1
1004	0xD7	dE-32	Retry monitor 2 Specific status	UINT	R	0 ~ 6	1
2004	0xD9	dE-32	Retry monitor 2 Running time	UDINT	R	0 ~ 1000000	1hr
2004	0xDB	dE-32	Retry monitor 2 Power-on time	UDINT	R	0 ~ 1000000	1hr

Index	Sub-index	Func code	Function name	Type	Access	Setting Items	Data resolution· units
1004	0xDD	dE-32	Retry monitor 2 Time (Year/Month)	UINT	R	00 ~ 99 (BCD code) 01 ~ 12 (BCD code)	1 1
1004	0xDE	dE-32	Retry monitor 2 Time (Day)	UINT	R	01 ~ 31 (BCD code) 00 ~ 06 (BCD code)	1 1
1004	0xDF	dE-32	Retry monitor 2 Time (Hour/Minute)	UINT	R	00 ~ 23 (BCD code) 00 ~ 59 (BCD code)	1 1
1004	0xE2	dE-33	Retry monitor 3 Factor	UINT	R	1 ~ 255	1
2004	0xE3	dE-33	Retry monitor 3 Output frequency (+/-)	UDINT	R	-59000 ~ 59000	0.01Hz
1004	0xE5	dE-33	Retry monitor 3 Output current	UINT	R	0 ~ 65535	0.01A
1004	0xE6	dE-33	Retry monitor 3 DC-bus voltage	UINT	R	0 ~ 10000	0.1Vdc
1004	0xE7	dE-33	Retry monitor 3 Inverter status	UINT	R	0 ~ 8	1
1004	0xE8	dE-33	Retry monitor 3 LAD status	UINT	R	0 ~ 5	1
1004	0xE9	dE-33	Retry monitor 3 Control mode	UINT	R	0 ~ 11	1
1004	0xEA	dE-33	Retry monitor 3 Limit status	UINT	R	0 ~ 6	1
1004	0xEB	dE-33	Retry monitor 3 Specific status	UINT	R	0 ~ 6	1
2004	0xED	dE-33	Retry monitor 3 Running time	UDINT	R	0 ~ 1000000	1hr
2004	0xEF	dE-33	Retry monitor 3 Power-on time	UDINT	R	0 ~ 1000000	1hr
1004	0xF1	dE-33	Retry monitor 3 Time (Year/Month)	UINT	R	00 ~ 99 (BCD code) 01 ~ 12 (BCD code)	1 1
1004	0xF2	dE-33	Retry monitor 3 Time (Day)	UINT	R	01 ~ 31 (BCD code) 00 ~ 06 (BCD code)	1 1
1004	0xF3	dE-33	Retry monitor 3 Time (Hour/Minute)	UINT	R	00 ~ 23 (BCD code) 00 ~ 59 (BCD code)	1 1
1004	0xF6	dE-34	Retry monitor 4 Factor	UINT	R	1 ~ 255	1
2004	0xF7	dE-34	Retry monitor 4 Output frequency (+/-)	UDINT	R	-59000 ~ 59000	0.01Hz
1004	0xF9	dE-34	Retry monitor 4 Output current	UINT	R	0 ~ 65535	0.01A
1004	0xFA	dE-34	Retry monitor 4 DC-bus voltage	UINT	R	0 ~ 10000	0.1Vdc
1004	0xFB	dE-34	Retry monitor 4 Inverter status	UINT	R	0 ~ 8	1
1004	0xFC	dE-34	Retry monitor 4 LAD status	UINT	R	0 ~ 5	1
1004	0xFD	dE-34	Retry monitor 4 Control mode	UINT	R	0 ~ 11	1

Index	Sub-index	Func code	Function name	Type	Access	Setting Items	Data resolution· units
1004	0xFE	dE-34	Retry monitor 4 Limit status	UINT	R	0 ~ 6	1
1005	0x1	dE-34	Retry monitor 4 Specific status	UINT	R	0 ~ 6	1
2005	0x3	dE-34	Retry monitor 4 Running time	UDINT	R	0 ~ 1000000	1hr
2005	0x5	dE-34	Retry monitor 4 Power-on time	UDINT	R	0 ~ 1000000	1hr
1005	0x7	dE-34	Retry monitor 4 Time (Year/Month)	UINT	R	00 ~ 99 (BCD code) 01 ~ 12 (BCD code)	1 1
1005	0x8	dE-34	Retry monitor 4 Time (Day)	UINT	R	01 ~ 31 (BCD code) 00 ~ 06 (BCD code)	1 1
1005	0x9	dE-34	Retry monitor 4 Time (Hour/Minute)	UINT	R	00 ~ 23 (BCD code) 00 ~ 59 (BCD code)	1 1
1005	0xC	dE-35	Retry monitor 5 Factor	UINT	R	1 ~ 255	1
2005	0xD	dE-35	Retry monitor 5 Output frequency (+/-)	UDINT	R	-59000 ~ 59000	0.01Hz
1005	0xF	dE-35	Retry monitor 5 Output current	UINT	R	0 ~ 65535	0.01A
1005	0x10	dE-35	Retry monitor 5 DC-bus voltage	UINT	R	0 ~ 10000	0.1Vdc
1005	0x11	dE-35	Retry monitor 5 Inverter status	UINT	R	0 ~ 8	1
1005	0x12	dE-35	Retry monitor 5 LAD status	UINT	R	0 ~ 5	1
1005	0x13	dE-35	Retry monitor 5 Control mode	UINT	R	0 ~ 11	1
1005	0x14	dE-35	Retry monitor 5 Limit status	UINT	R	0 ~ 6	1
1005	0x15	dE-35	Retry monitor 5 Specific status	UINT	R	0 ~ 6	1
2005	0x17	dE-35	Retry monitor 5 Running time	UDINT	R	0 ~ 1000000	1hr
2005	0x19	dE-35	Retry monitor 5 Power-on time	UDINT	R	0 ~ 1000000	1hr
1005	0x1B	dE-35	Retry monitor 5 Time (Year/Month)	UINT	R	00 ~ 99 (BCD code) 01 ~ 12 (BCD code)	1 1
1005	0x1C	dE-35	Retry monitor 5 Time (Day)	UINT	R	01 ~ 31 (BCD code) 00 ~ 06 (BCD code)	1 1
1005	0x1D	dE-35	Retry monitor 5 Time (Hour/Minute)	UINT	R	00 ~ 23 (BCD code) 00 ~ 59 (BCD code)	1 1
1005	0x20	dE-36	Retry monitor 6 Factor	UINT	R	1 ~ 255	1
2005	0x21	dE-36	Retry monitor 6 Output frequency (+/-)	UDINT	R	-59000 ~ 59000	0.01Hz
1005	0x23	dE-36	Retry monitor 6 Output current	UINT	R	0 ~ 65535	0.01A

Index	Sub-index	Func code	Function name	Type	Access	Setting Items	Data resolution· units
1005	0x24	dE-36	Retry monitor 6 DC-bus voltage	UINT	R	0 ~ 10000	0.1Vdc
1005	0x25	dE-36	Retry monitor 6 Inverter status	UINT	R	0 ~ 8	1
1005	0x26	dE-36	Retry monitor 6 LAD status	UINT	R	0 ~ 5	1
1005	0x27	dE-36	Retry monitor 6 Control mode	UINT	R	0 ~ 11	1
1005	0x28	dE-36	Retry monitor 6 Limit status	UINT	R	0 ~ 6	1
1005	0x29	dE-36	Retry monitor 6 Specific status	UINT	R	0 ~ 6	1
2005	0x2B	dE-36	Retry monitor 6 Running time	UDINT	R	0 ~ 1000000	1hr
2005	0x2D	dE-36	Retry monitor 6 Power-on time	UDINT	R	0 ~ 1000000	1hr
1005	0x2F	dE-36	Retry monitor 6 Time (Year/Month)	UINT	R	00 ~ 99 (BCD code) 01 ~ 12 (BCD code)	1 1
1005	0x30	dE-36	Retry monitor 6 Time (Day)	UINT	R	01 ~ 31 (BCD code) 00 ~ 06 (BCD code)	1 1
1005	0x31	dE-36	Retry monitor 6 Time (Hour/Minute)	UINT	R	00 ~ 23 (BCD code) 00 ~ 59 (BCD code)	1 1
1005	0x34	dE-37	Retry monitor 7 Factor	UINT	R	1 ~ 255	1
2005	0x35	dE-37	Retry monitor 7 Output frequency (+/-)	UDINT	R	-59000 ~ 59000	0.01Hz
1005	0x37	dE-37	Retry monitor 7 Output current	UINT	R	0 ~ 65535	0.01A
1005	0x38	dE-37	Retry monitor 7 DC-bus voltage	UINT	R	0 ~ 10000	0.1Vdc
1005	0x39	dE-37	Retry monitor 7 Inverter status	UINT	R	0 ~ 8	1
1005	0x3A	dE-37	Retry monitor 7 LAD status	UINT	R	0 ~ 5	1
1005	0x3B	dE-37	Retry monitor 7 Control mode	UINT	R	0 ~ 11	1
1005	0x3C	dE-37	Retry monitor 7 Limit status	UINT	R	0 ~ 6	1
1005	0x3D	dE-37	Retry monitor 7 Specific status	UINT	R	0 ~ 6	1
2005	0x3F	dE-37	Retry monitor 7 Running time	UDINT	R	0 ~ 1000000	1hr
2005	0x41	dE-37	Retry monitor 7 Power-on time	UDINT	R	0 ~ 1000000	1hr
1005	0x43	dE-37	Retry monitor 7 Time (Year/Month)	UINT	R	00 ~ 99 (BCD code) 01 ~ 12 (BCD code)	1 1
1005	0x44	dE-37	Retry monitor 7 Time (Day)	UINT	R	01 ~ 31 (BCD code) 00 ~ 06 (BCD code)	1 1

Index	Sub-index	Func code	Function name	Type	Access	Setting Items	Data resolution· units
1005	0x45	dE-37	Retry monitor 7 Time (Hour/Minute)	UINT	R	00 ~ 23 (BCD code) 00 ~ 59 (BCD code)	1 1
1005	0x48	dE-38	Retry monitor 8 Factor	UINT	R	1 ~ 255	1
2005	0x49	dE-38	Retry monitor 8 Output frequency (+/-)	UDINT	R	-59000 ~ 59000	0.01Hz
1005	0x4B	dE-38	Retry monitor 8 Output current	UINT	R	0 ~ 65535	0.01A
1005	0x4C	dE-38	Retry monitor 8 DC-bus voltage	UINT	R	0 ~ 10000	0.1Vdc
1005	0x4D	dE-38	Retry monitor 8 Inverter status	UINT	R	0 ~ 8	1
1005	0x4E	dE-38	Retry monitor 8 LAD status	UINT	R	0 ~ 5	1
1005	0x4F	dE-38	Retry monitor 8 Control mode	UINT	R	0 ~ 11	1
1005	0x50	dE-38	Retry monitor 8 Limit status	UINT	R	0 ~ 6	1
1005	0x51	dE-38	Retry monitor 8 Specific status	UINT	R	0 ~ 6	1
2005	0x53	dE-38	Retry monitor 8 Running time	UDINT	R	0 ~ 1000000	1hr
2005	0x55	dE-38	Retry monitor 8 Power-on time	UDINT	R	0 ~ 1000000	1hr
1005	0x57	dE-38	Retry monitor 8 Time (Year/Month)	UINT	R	00 ~ 99 (BCD code) 01 ~ 12 (BCD code)	1 1
1005	0x58	dE-38	Retry monitor 8 Time (Day)	UINT	R	01 ~ 31 (BCD code) 00 ~ 06 (BCD code)	1 1
1005	0x59	dE-38	Retry monitor 8 Time (Hour/Minute)	UINT	R	00 ~ 23 (BCD code) 00 ~ 59 (BCD code)	1 1
1005	0x5C	dE-39	Retry monitor 9 Factor	UINT	R	1 ~ 255	1
2005	0x5D	dE-39	Retry monitor 9 Output frequency (+/-)	UDINT	R	-59000 ~ 59000	0.01Hz
1005	0x5F	dE-39	Retry monitor 9 Output current	UINT	R	0 ~ 65535	0.01A
1005	0x60	dE-39	Retry monitor 9 DC-bus voltage	UINT	R	0 ~ 10000	0.1Vdc
1005	0x61	dE-39	Retry monitor 9 Inverter status	UINT	R	0 ~ 8	1
1005	0x62	dE-39	Retry monitor 9 LAD status	UINT	R	0 ~ 5	1
1005	0x63	dE-39	Retry monitor 9 Control mode	UINT	R	0 ~ 11	1
1005	0x64	dE-39	Retry monitor 9 Limit status	UINT	R	0 ~ 6	1
1005	0x65	dE-39	Retry monitor 9 Specific status	UINT	R	0 ~ 6	1

Index	Sub-index	Func code	Function name	Type	Access	Setting Items	Data resolution· units
2005	0x67	dE-39	Retry monitor 9 Running time	UDINT	R	0 ~ 1000000	1hr
2005	0x69	dE-39	Retry monitor 9 Power-on time	UDINT	R	0 ~ 1000000	1hr
1005	0x6B	dE-39	Retry monitor 9 Time (Year/Month)	UINT	R	00 ~ 99 (BCD code) 01 ~ 12 (BCD code)	1 1
1005	0x6C	dE-39	Retry monitor 9 Time (Day)	UINT	R	01 ~ 31 (BCD code) 00 ~ 06 (BCD code)	1 1
1005	0x6D	dE-39	Retry monitor 9 Time (Hour/Minute)	UINT	R	00 ~ 23 (BCD code) 00 ~ 59 (BCD code)	1 1
1005	0x70	dE-40	Retry monitor 10 Factor	UINT	R	1 ~ 255	1
2005	0x71	dE-40	Retry monitor 10 Output frequency (+/-)	UDINT	R	-59000 ~ 59000	0.01Hz
1005	0x73	dE-40	Retry monitor 10 Output current	UINT	R	0 ~ 65535	0.01A
1005	0x74	dE-40	Retry monitor 10 DC-bus voltage	UINT	R	0 ~ 10000	0.1Vdc
1005	0x75	dE-40	Retry monitor 10 Inverter status	UINT	R	0 ~ 8	1
1005	0x76	dE-40	Retry monitor 10 LAD status	UINT	R	0 ~ 5	1
1005	0x77	dE-40	Retry monitor 10 Control mode	UINT	R	0 ~ 11	1
1005	0x78	dE-40	Retry monitor 10 Limit status	UINT	R	0 ~ 6	1
1005	0x79	dE-40	Retry monitor 10 Specific status	UINT	R	0 ~ 6	1
2005	0x7B	dE-40	Retry monitor 10 Running time	UDINT	R	0 ~ 1000000	1hr
2005	0x7D	dE-40	Retry monitor 10 Power-on time	UDINT	R	0 ~ 1000000	1hr
1005	0x7F	dE-40	Retry monitor 10 Time (Year/Month)	UINT	R	00 ~ 99 (BCD code) 01 ~ 12 (BCD code)	1 1
1005	0x80	dE-40	Retry monitor 10 Time (Day)	UINT	R	01 ~ 31 (BCD code) 00 ~ 06 (BCD code)	1 1
1005	0x81	dE-40	Retry monitor 10 Time (Hour/Minute)	UINT	R	00 ~ 23 (BCD code) 00 ~ 59 (BCD code)	1 1
1005	0xE7	dE-50	Warning monitor	UINT	R	0 ~ 65535	1

## 13.2.2 Code-F

Index	Sub-index	Func code	Function name	type	Access	Setting Items	Data resolution·units
1043	0x50	FA-01	Main Speed reference monitor	UINT	RW	0 ~ 59000	0.01Hz
2043	0x51	FA-02	Sub Speed reference monitor	UDINT	RW	-59000 ~ 59000 (monitor) 0 ~ 59000 (setting)	0.01Hz
2043	0x59	FA-10	Acceleration time monitor	UDINT	RW	0 ~ 360000	0.01s
2043	0x5B	FA-12	Deceleration time monitor	UDINT	RW	0 ~ 360000	0.01s
1043	0x5E	FA-15	Torque reference monitor	UINT	RW	-5000 ~ 5000	0.1%
1043	0x5F	FA-16	Torque bias monitor	UINT	RW	-5000 ~ 5000	0.1%
2043	0x63	FA-20	Position reference monitor	UDINT	RW	-268435455 ~ 268435455 High resolution mode : -1073741823 ~ 1073741823	1
2043	0x6D	FA-30	PID1 Set Value 1 monitor	UDINT	RW	-10000 ~ 10000	Depends on AH-06
2043	0x6F	FA-32	PID1 Set Value 2 monitor	UDINT	RW	-10000 ~ 10000	Depends on AH-06
2043	0x71	FA-34	PID1 Set Value 3 monitor	UDINT	RW	-10000 ~ 10000	Depends on AH-06
2043	0x73	FA-36	PID2 Set Value monitor	UDINT	RW	-10000 ~ 10000	Depends on AH-06
2043	0x75	FA-38	PID3 Set Value monitor	UDINT	RW	-10000 ~ 10000	Depends on AH-26
2043	0x77	FA-40	PID4 Set Value monitor	UDINT	RW	-10000 ~ 10000	Depends on AH-46

## 13.2.3 Code-A

Index	Sub-index	Func code	Function name	Type	Access	Setting Items	Data resolution·units
1047	0x40	AA101	Main speed input source selection, 1st-motor	UINT	RW	1 ~ 16	1
1047	0x41	AA102	Sub frequency input source selection, 1st-motor	UINT	RW	0 ~ 16	1
1047	0x43	AA104	Sub speed setting, 1st-motor	UINT	RW	0 ~ 59000	0.01Hz



Index	Sub-index	Func code	Function name	Type	Access	Setting Items	Data resolution· units
1047	0x44	AA105	Calculation symbol selection for Speed reference, 1st-motor	UINT	RW	0 ~ 3	1
2047	0x45	AA106	Add frequency setting, 1st-motor	UDINT	RW	-59000 ~ 59000	0.01Hz
1047	0x4A	AA111	Run-command input source selection, 1st-motor	UINT	RW	0 ~ 6	1
1047	0x4B	AA-12	RUN-key Direction of Keypad, 1st-motor	UINT	RW	0 ~ 1	1
1047	0x4C	AA-13	STOP-key enable at RUN-command from terminal, 1st-motor	UINT	RW	0 ~ 2	1
1047	0x4D	AA114	RUN-direction restriction, 1st-motor	UINT	RW	0 ~ 2	1
1047	0x4E	AA115	STOP mode selection, 1st-motor	UINT	RW	0 ~ 1	1
1047	0x54	AA121	Control mode selection, 1st-motor	UINT	RW	0 ~ 12	1
1047	0x56	AA123	Vector control mode selection, 1st-motor	UINT	RW	0 ~ 3	1
1086	0x9E	AA201	Main speed input source selection, 2nd-motor	UINT	RW	1 ~ 16	1
1086	0x9F	AA202	Sub speed input source selection, 2nd-motor	UINT	RW	0 ~ 16	1
1086	0xA1	AA204	Sub speed setting, 2nd-motor	UINT	RW	0 ~ 59000	0.01Hz
1086	0xA2	AA205	Calculation symbol selection for Speed reference, 2nd-motor	UINT	RW	0 ~ 3	1
2086	0xA3	AA206	Add frequency setting, 2nd-motor	UDINT	RW	-59000 ~ 59000	0.01Hz
1086	0xA8	AA211	Run-command input source selection, 2nd-motor	UINT	RW	0 ~ 6	1

Index	Sub-index	Func code	Function name	Type	Access	Setting Items	Data resolution· units
1086	0xAB	AA214	RUN-direction restriction, 1st-motor	UINT	RW	0 ~ 2	1
1086	0xAC	AA215	STOP mode selection, 1st-motor	UINT	RW	0 ~ 1	1
1086	0xB2	AA221	Control mode selection, 2nd-motor	UINT	RW	0 ~ 11	1
1086	0xB4	AA223	Vector control mode selection, 2nd-motor	UINT	RW	0 ~ 3	1
1047	0xA4	Ab-01	Frequency conversion gain	UINT	RW	1 ~ 10000	0.01
1047	0xA6	Ab-03	Multispeed operation selection	UINT	RW	0 ~ 1	1
1047	0xAD	Ab110	Multispeed-0 setting, 1st-motor	UINT	RW	0 ~ 59000	0.01Hz
1047	0xAE	Ab-11	Multispeed-1 setting	UINT	RW	0 ~ 59000	0.01Hz
1047	0xAF	Ab-12	Multispeed-2 setting	UINT	RW	0 ~ 59000	0.01Hz
1047	0xB0	Ab-13	Multispeed-3 setting	UINT	RW	0 ~ 59000	0.01Hz
1047	0xB1	Ab-14	Multispeed-4 setting	UINT	RW	0 ~ 59000	0.01Hz
1047	0xB2	Ab-15	Multispeed-5 setting	UINT	RW	0 ~ 59000	0.01Hz
1047	0xB3	Ab-16	Multispeed-6 setting	UINT	RW	0 ~ 59000	0.01Hz
1047	0xB4	Ab-17	Multispeed-7 setting	UINT	RW	0 ~ 59000	0.01Hz
1047	0xB5	Ab-18	Multispeed-8 setting	UINT	RW	0 ~ 59000	0.01Hz
1047	0xB6	Ab-19	Multispeed-9 setting	UINT	RW	0 ~ 59000	0.01Hz
1047	0xB7	Ab-20	Multispeed-10 setting	UINT	RW	0 ~ 59000	0.01Hz
1047	0xB8	Ab-21	Multispeed-11 setting	UINT	RW	0 ~ 59000	0.01Hz
1047	0xB9	Ab-22	Multispeed-12 setting	UINT	RW	0 ~ 59000	0.01Hz
1047	0xBA	Ab-23	Multispeed-13 setting	UINT	RW	0 ~ 59000	0.01Hz
1047	0xBB	Ab-24	Multispeed-14 setting	UINT	RW	0 ~ 59000	0.01Hz
1047	0xBC	Ab-25	Multispeed-15 setting	UINT	RW	0 ~ 59000	0.01Hz
1087	0xD	Ab210	Multispeed-0 setting, 2nd-motor	UINT	RW	0 ~ 59000	0.01Hz

Index	Sub-index	Func code	Function name	Type	Access	Setting Items	Data resolution· units
1048	0xA	AC-01	Acceleration/ Deceleration Time input selection	UINT	RW	0 ~ 4	1
1048	0xB	AC-02	Acceleration/ Deceleration Selection	UINT	RW	0 ~ 1	1
1048	0xC	AC-03	Acceleration curve selection	UINT	RW	0 ~ 4	1
1048	0xD	AC-04	Deceleration curve selection	UINT	RW	0 ~ 4	1
1048	0xE	AC-05	Acceleration curve constant setting	UINT	RW	1 ~ 10	1
1048	0xF	AC-06	Deceleration curve constant setting	UINT	RW	1 ~ 10	1
1048	0x11	AC-08	EL-S-curve ratio @start of acceleration	UINT	RW	0 ~ 100	1%
1048	0x12	AC-09	EL-S-curve ratio @end of acceleration	UINT	RW	0 ~ 100	1%
1048	0x13	AC-10	EL-S-curve ratio @start of deceleration	UINT	RW	0 ~ 100	1%
1048	0x14	AC-11	EL-S-curve ratio @end of deceleration	UINT	RW	0 ~ 100	1%
1048	0x18	AC115	Select method to switch to Accel2/Decel2 Profile, 1st-motor	UINT	RW	0 ~ 2	1
1048	0x19	AC116	Accel1 to Accel2 Frequency transition point, 1st-motor	UINT	RW	0 ~ 59000	0.01Hz
1048	0x1A	AC117	Decel1 to Decel2 Frequency transition point, 1st-motor	UINT	RW	0 ~ 59000	0.01Hz
2048	0x1D	AC120	Acceleration time setting 1, 1st-motor	UDINT	RW	0 ~ 360000	0.01s
2048	0x1F	AC122	Deceleration time setting 1, 1st-motor	UDINT	RW	0 ~ 360000	0.01s
2048	0x21	AC124	Acceleration time setting 2 1st-motor	UDINT	RW	0 ~ 360000	0.01s
2048	0x23	AC126	Deceleration time setting 2, 1st-motor	UDINT	RW	0 ~ 360000	0.01s

Index	Sub-index	Func code	Function name	Type	Access	Setting Items	Data resolution· units
2048	0x27	AC-30	Acceleration time setting for Multispeed-1	UDINT	RW	0 ~ 360000	0.01s
2048	0x29	AC-32	Deceleration time setting for Multispeed-1	UDINT	RW	0 ~ 360000	0.01s
2048	0x2B	AC-34	Acceleration time setting for Multispeed-2	UDINT	RW	0 ~ 360000	0.01s
2048	0x2D	AC-36	Deceleration time setting for Multispeed-2	UDINT	RW	0 ~ 360000	0.01s
2048	0x2F	AC-38	Acceleration time setting for Multispeed-3	UDINT	RW	0 ~ 360000	0.01s
2048	0x31	AC-40	Deceleration time setting for Multispeed-3	UDINT	RW	0 ~ 360000	0.01s
2048	0x33	AC-42	Acceleration time setting for Multispeed-4	UDINT	RW	0 ~ 360000	0.01s
2048	0x35	AC-44	Deceleration time setting for Multispeed-4	UDINT	RW	0 ~ 360000	0.01s
2048	0x37	AC-46	Acceleration time setting for Multispeed-5	UDINT	RW	0 ~ 360000	0.01s
2048	0x39	AC-48	Deceleration time setting for Multispeed-5	UDINT	RW	0 ~ 360000	0.01s
2048	0x3B	AC-50	Acceleration time setting for Multispeed-6	UDINT	RW	0 ~ 360000	0.01s
2048	0x3D	AC-52	Deceleration time setting for Multispeed-6	UDINT	RW	0 ~ 360000	0.01s
2048	0x3F	AC-54	Acceleration time setting for Multispeed-7	UDINT	RW	0 ~ 360000	0.01s
2048	0x41	AC-56	Deceleration time setting for Multispeed-7	UDINT	RW	0 ~ 360000	0.01s
2048	0x43	AC-58	Acceleration time setting for Multispeed-8	UDINT	RW	0 ~ 360000	0.01s
2048	0x45	AC-60	Deceleration time setting for Multispeed-8	UDINT	RW	0 ~ 360000	0.01s
2048	0x47	AC-62	Acceleration time setting for Multispeed-9	UDINT	RW	0 ~ 360000	0.01s
2048	0x49	AC-64	Deceleration time setting for Multispeed-9	UDINT	RW	0 ~ 360000	0.01s

Index	Sub-index	Func code	Function name	Type	Access	Setting Items	Data resolution· units
2048	0x4B	AC-66	Acceleration time setting for Multispeed-10	UDINT	RW	0 ~ 360000	0.01s
2048	0x4D	AC-68	Deceleration time setting for Multispeed-10	UDINT	RW	0 ~ 360000	0.01s
2048	0x4F	AC-70	Acceleration time setting for Multispeed-11	UDINT	RW	0 ~ 360000	0.01s
2048	0x51	AC-72	Deceleration time setting for Multispeed-11	UDINT	RW	0 ~ 360000	0.01s
2048	0x53	AC-74	Acceleration time setting for Multispeed-12	UDINT	RW	0 ~ 360000	0.01s
2048	0x55	AC-76	Deceleration time setting for Multispeed-12	UDINT	RW	0 ~ 360000	0.01s
2048	0x57	AC-78	Acceleration time setting for Multispeed-13	UDINT	RW	0 ~ 360000	0.01s
2048	0x59	AC-80	Deceleration time setting for Multispeed-13	UDINT	RW	0 ~ 360000	0.01s
2048	0x5B	AC-82	Acceleration time setting for Multispeed-14	UDINT	RW	0 ~ 360000	0.01s
2048	0x5D	AC-84	Deceleration time setting for Multispeed-14	UDINT	RW	0 ~ 360000	0.01s
2048	0x5F	AC-86	Acceleration time setting for Multispeed-15	UDINT	RW	0 ~ 360000	0.01s
2048	0x61	AC-88	Deceleration time setting for Multispeed-15	UDINT	RW	0 ~ 360000	0.01s
1087	0x76	AC215	Select method to switch to Accel2/Decel2 Profile, 2nd-motor	UINT	RW	0 ~ 2	1
1087	0x77	AC216	Accel1 to Accel2 Frequency transition point, 2nd-motor	UINT	RW	0 ~ 59000	0.01Hz
1087	0x78	AC217	Decel1 to Decel2 Frequency transition point, 2nd-motor	UINT	RW	0 ~ 59000	0.01Hz
2087	0x7B	AC220	Acceleration time setting 1, 2nd-motor	UDINT	RW	0 ~ 360000	0.01s

Index	Sub-index	Func code	Function name	Type	Access	Setting Items	Data resolution· units
2087	0x7D	AC222	Deceleration time setting 1, 2nd-motor	UDINT	RW	0 ~ 360000	0.01s
2087	0x7F	AC224	Acceleration time setting 2, 2nd-motor	UDINT	RW	0 ~ 360000	0.01s
2087	0x81	AC226	Deceleration time setting 2, 2nd-motor	UDINT	RW	0 ~ 360000	0.01s
1048	0x6E	Ad-01	Torque reference input source selection	UINT	RW	1 ~ 15	1
1048	0x6F	Ad-02	Torque reference value setting	UINT	RW	-5000 ~ 5000	0.1%
1048	0x70	Ad-03	Polarity selection for torque reference	UINT	RW	0 ~ 1	1
1048	0x71	Ad-04	Switching time of Speed control to Torque control	UINT	RW	0 ~ 1000	1ms
1048	0x78	Ad-11	Torque bias input source selection	UINT	RW	0 ~ 15	1
1048	0x79	Ad-12	Torque bias value setting	UINT	RW	-5000 ~ 5000	0.1%
1048	0x7A	Ad-13	Polarity selection for torque bias	UINT	RW	0 ~ 1	1
1048	0x7B	Ad-14	Term.[TBS] sel.	UINT	RW	0 ~ 1	1
1048	0x95	Ad-40	Input selection for speed limit at torque control	UINT	RW	1 ~ 13	1
1048	0x96	Ad-41	Speed limit at torque control (at Forward rotation)	UINT	RW	0 ~ 59000	0.01Hz
1048	0x97	Ad-42	Speed limit at torque control (at Reverse rotation)	UINT	RW	0 ~ 59000	0.01Hz
1048	0xD2	AE-01	Electronic gear setting point selection	UINT	RW	0 ~ 1	1
1048	0xD3	AE-02	Electronic gear ratio numerator	UINT	RW	1 ~ 10000	1
1048	0xD4	AE-03	Electronic gear ratio denominator	UINT	RW	1 ~ 10000	1
1048	0xD5	AE-04	Positioning complete range setting	UINT	RW	0 ~ 10000	1pls
1048	0xD6	AE-05	Positioning complete delay time setting	UINT	RW	0 ~ 1000	0.01s

Index	Sub-index	Func code	Function name	Type	Access	Setting Items	Data resolution· units
1048	0xD7	AE-06	Position feed-forward gain setting	UINT	RW	0 ~ 65535	0.01
1048	0xD8	AE-07	Position loop gain setting	UINT	RW	0 ~ 10000	0.01
1048	0xD9	AE-08	Position bias setting	UINT	RW	-2048 ~ 2048	1pls
1048	0xDB	AE-10	Stop position selection of Home search function	UINT	RW	0 ~ 3	1
1048	0xDC	AE-11	Stop position of Home search function	UINT	RW	0 ~ 4095	1
1048	0xDD	AE-12	Speed reference of Home search function	UINT	RW	0 ~ 12000	0.01Hz
1048	0xDE	AE-13	Direction of Home search function	UINT	RW	0 ~ 1	1
2048	0xE5	AE-20	Position reference 0 setting	UDINT	RW	-268435455 ~ 268435455 High resolution mode : -1073741823 ~ 1073741823	1pls
2048	0xE7	AE-22	Position reference 1 setting	UDINT	RW	-268435455 ~ 268435455 High resolution mode : -1073741823 ~ 1073741823	1pls
2048	0xE9	AE-24	Position reference 2 setting	UDINT	RW	-268435455 ~ 268435455 High resolution mode : -1073741823 ~ 1073741823	1pls
2048	0xEB	AE-26	Position reference 3 setting	UDINT	RW	-268435455 ~ 268435455 High resolution mode : -1073741823 ~ 1073741823	1pls
2048	0xED	AE-28	Position reference 4 setting	UDINT	RW	-268435455 ~ 268435455 High resolution mode : -1073741823 ~ 1073741823	1pls
2048	0xEF	AE-30	Position reference 5 setting	UDINT	RW	-268435455 ~ 268435455 High resolution mode : -1073741823 ~ 1073741823	1pls
2048	0xF1	AE-32	Position reference 6 setting	UDINT	RW	-268435455 ~ 268435455 High resolution mode : -1073741823 ~ 1073741823	1pls
2048	0xF3	AE-34	Position reference 7 setting	UDINT	RW	-268435455 ~ 268435455 High resolution mode : -1073741823 ~ 1073741823	1pls
2048	0xF5	AE-36	Position reference 8 setting	UDINT	RW	-268435455 ~ 268435455 High resolution mode : -1073741823 ~ 1073741823	1pls
2048	0xF7	AE-38	Position reference 9 setting	UDINT	RW	-268435455 ~ 268435455 High resolution mode : -1073741823 ~ 1073741823	1pls
2048	0xF9	AE-40	Position reference 10 setting	UDINT	RW	-268435455 ~ 268435455 High resolution mode : -1073741823 ~ 1073741823	1pls

Index	Sub-index	Func code	Function name	Type	Access	Setting Items	Data resolution· units
2048	0xFB	AE-42	Position reference 11 setting	UDINT	RW	-268435455 ~ 268435455 High resolution mode : -1073741823 ~ 1073741823	1pls
2048	0xFD	AE-44	Position reference 12 setting	UDINT	RW	-268435455 ~ 268435455 High resolution mode : -1073741823 ~ 1073741823	1pls
2049	0x1	AE-46	Position reference 13 setting	UDINT	RW	-268435455 ~ 268435455 High resolution mode : -1073741823 ~ 1073741823	1pls
2049	0x3	AE-48	Position reference 14 setting	UDINT	RW	-268435455 ~ 268435455 High resolution mode : -1073741823 ~ 1073741823	1pls
2049	0x5	AE-50	Position reference 15 setting	UDINT	RW	-268435455 ~ 268435455 High resolution mode : -1073741823 ~ 1073741823	1pls
2049	0x7	AE-52	Position control range setting(forward)	UDINT	RW	0 ~ 268435455 High resolution mode : 0 ~ 1073741823	1pls
2049	0x9	AE-54	Position control range setting(reverse)	UDINT	RW	-268435455 ~ 0 High resolution mode : -1073741823 ~ 0	1pls
1049	0xB	AE-56	Position control mode selection	UINT	RW	0 ~ 1	1
1049	0xF	AE-60	Teach-in function target selection	UINT	RW	0 ~ 15	1
1049	0x10	AE-61	Current position saving at power-off	UINT	RW	0 ~ 1	1
2049	0x11	AE-62	Preset position data	UDINT	RW	-268435455 ~ 268435455 High resolution mode : -1073741823 ~ 1073741823	1pls
1049	0x13	AE-64	Deceleration stop distance calculation Gain	UINT	RW	5000 ~ 20000	0.01%
1049	0x14	AE-65	Deceleration stop distance calculation Bias	UINT	RW	0 ~ 65535	0.01%
1049	0x15	AE-66	Speed Limit in APR control	UINT	RW	0 ~ 10000	0.01%
1049	0x16	AE-67	APR start speed	UINT	RW	0 ~ 10000	0.01%
1049	0x19	AE-70	Homing function selection	UINT	RW	0 ~ 2	1
1049	0x1A	AE-71	Direction of Homing function	UINT	RW	0 ~ 1	1
1049	0x1B	AE-72	Low-speed of homing function	UINT	RW	0 ~ 1000	0.01Hz
1049	0x1C	AE-73	High-Speed of homing function	UINT	RW	0 ~ 59000	0.01Hz
1049	0x38	AF101	DC braking selection, 1st-motor	UINT	RW	0 ~ 2	1
1049	0x39	AF102	Braking type selection, 1st-motor	UINT	RW	0 ~ 2	1



Index	Sub-index	Func code	Function name	Type	Access	Setting Items	Data resolution· units
1049	0x3A	AF103	DC braking frequency, 1st-motor	UINT	RW	0 ~ 59000	0.01Hz
1049	0x3B	AF104	DC braking delay time, 1st-motor	UINT	RW	0 ~ 500	0.01s
1049	0x3C	AF105	DC braking force setting, 1st-motor	UINT	RW	0 ~ 100	1%
1049	0x3D	AF106	DC braking active time at stop, 1st-motor	UINT	RW	0 ~ 6000	0.01s
1049	0x3E	AF107	DC braking operation method selection, 1st-motor	UINT	RW	0 ~ 1	1
1049	0x3F	AF108	DC braking force at start, 1st-motor	UINT	RW	0 ~ 100	1%
1049	0x40	AF109	DC braking active time at start, 1st-motor	UINT	RW	0 ~ 6000	0.01s
1049	0x4B	AF120	ContactoControl Enable, 1st-motor	UINT	RW	0 ~ 2	1
1049	0x4C	AF121	Run delay time, 1st-motor	UINT	RW	0 ~ 200	0.01s
1049	0x4D	AF122	ContactoControl off delay time, 1st-motor	UINT	RW	0 ~ 200	0.01s
1049	0x4E	AF123	ContactoControl answer back check time, 1st-motor	UINT	RW	0 ~ 500	0.01s
1049	0x55	AF130	Brake Control Enable, 1st-motor	UINT	RW	0 ~ 3	1
1049	0x56	AF131	Brake Wait Time for Release, 1st-motor (Forward side)	UINT	RW	0 ~ 500	0.01s
1049	0x57	AF132	Brake Wait Time for Accel. , 1st-motor (Forward side)	UINT	RW	0 ~ 500	0.01s
1049	0x58	AF133	Brake Wait Time for Stopping, 1st-motor (Forward side)	UINT	RW	0 ~ 500	0.01s
1049	0x59	AF134	Brake Wait Time for Confirmation, 1st-motor (Forward side)	UINT	RW	0 ~ 500	0.01s

Index	Sub-index	Func code	Function name	Type	Access	Setting Items	Data resolution· units
1049	0x5A	AF135	Brake Release Frequency Setting, 1st-motor (Forward side)	UINT	RW	0 ~ 59000	0.01Hz
1049	0x5B	AF136	Brake Release Current Setting, 1st-motor (Forward side)	UINT	RW	(0~2.00)*CTL Rated current	0.1A
1049	0x5C	AF137	Braking Frequency, 1st-motor (Forward side)	UINT	RW	0 ~ 59000	0.01Hz
1049	0x5D	AF138	Brake Wait Time for Release, 1st-motor (Reverse side)	UINT	RW	0 ~ 500	0.01s
1049	0x5E	AF139	Brake Wait Time for Accel. , 1st-motor (Reverse side)	UINT	RW	0 ~ 500	0.01s
1049	0x5F	AF140	Brake Wait Time for Stopping, 1st-motor (Reverse side)	UINT	RW	0 ~ 500	0.01s
1049	0x60	AF141	Brake Wait Time for Confirmation, 1st-motor (Reverse side)	UINT	RW	0 ~ 500	0.01s
1049	0x61	AF142	Brake Release Frequency Setting, 1st-motor (Reverse side)	UINT	RW	0 ~ 59000	0.01Hz
1049	0x62	AF143	Brake Release Current Setting, 1st-motor (Reverse side)	UINT	RW	(0~2.00)*CTL Rated current	0.1A
1049	0x63	AF144	Braking Frequency, 1st-motor (Reverse side)	UINT	RW	0 ~ 59000	0.01Hz
1049	0x69	AF150	Brake open delay time, 1st-motor	UINT	RW	0 ~ 200	0.01s
1049	0x6A	AF151	Brake close delay time, 1st-motor	UINT	RW	0 ~ 200	0.01s
1049	0x6B	AF152	Brake answer back check time, 1st-motor	UINT	RW	0 ~ 500	0.01s
1049	0x6C	AF153	Servo lock/ DC injection time at start, 1st-motor	UINT	RW	0 ~ 1000	0.01s

Index	Sub-index	Func code	Function name	Type	Access	Setting Items	Data resolution· units
1049	0x6D	AF154	Servo lock/ DC injection time at stop, 1st-motor	UINT	RW	0 ~ 1000	0.01s
1088	0x96	AF201	DC braking selection, 2nd-motor	UINT	RW	0 ~ 2	1
1088	0x97	AF202	Braking type selection, 2nd-motor	UINT	RW	0 ~ 2	1
1088	0x98	AF203	DC braking frequency, 1st-motor	UINT	RW	0 ~ 59000	0.01Hz
1088	0x99	AF204	DC braking delay time, 2nd-motor	UINT	RW	0 ~ 500	0.01s
1088	0x9A	AF205	DC braking force setting, 2nd-motor	UINT	RW	0 ~ 100	1%
1088	0x9B	AF206	DC braking active time at stop, 2nd-motor	UINT	RW	0 ~ 6000	0.01s
1088	0x9C	AF207	DC braking operation method selection, 2nd-motor	UINT	RW	0 ~ 1	1
1088	0x9D	AF208	DC braking force at start, 2nd-motor	UINT	RW	0 ~ 100	1%
1088	0x9E	AF209	DC braking active time at start, 2nd-motor	UINT	RW	0 ~ 6000	0.01s
1088	0xA9	AF220	ContactoControl Enable, 2nd-motor	UINT	RW	0 ~ 2	1
1088	0xAA	AF221	Run delay time, 2nd-motor	UINT	RW	0 ~ 200	0.01s
1088	0xAB	AF222	ContactoControl off delay time, 2nd-motor	UINT	RW	0 ~ 200	0.01s
1088	0xAC	AF223	ContactoControl answer back check time, 2nd-motor	UINT	RW	0 ~ 500	0.01s
1088	0xB3	AF230	Brake Control Enable, 2nd-motor	UINT	RW	0 ~ 3	1
1088	0xB4	AF231	Brake Wait Time for Release, 2nd-motor (Forward side)	UINT	RW	0 ~ 500	0.01s
1088	0xB5	AF232	Brake Wait Time for Accel., 2nd-motor (Forward side)	UINT	RW	0 ~ 500	0.01s

Index	Sub-index	Func code	Function name	Type	Access	Setting Items	Data resolution· units
1088	0xB6	AF233	Brake Wait Time for Stopping, 2nd-motor (Forward side)	UINT	RW	0 ~ 500	0.01s
1088	0xB7	AF234	Brake Wait Time for Confirmation, 2nd-motor (Forward side)	UINT	RW	0 ~ 500	0.01s
1088	0xB8	AF235	Brake Release Frequency Setting, 2nd-motor (Forward side)	UINT	RW	0 ~ 59000	0.01Hz
1088	0xB9	AF236	Brake Release Current Setting, 2nd-motor (Forward side)	UINT	RW	(0~2.00)*CTL Rated current	0.1A
1088	0xBA	AF237	Braking Frequency, 2nd-motor (Forward side)	UINT	RW	0 ~ 59000	0.01Hz
1088	0xBB	AF238	Brake Wait Time for Release, 2nd-motor (Reverse side)	UINT	RW	0 ~ 500	0.01s
1088	0xBC	AF239	Brake Wait Time for Accel. , 2nd-motor (Reverse side)	UINT	RW	0 ~ 500	0.01s
1088	0xBD	AF240	Brake Wait Time for Stopping, 2nd-motor (Reverse side)	UINT	RW	0 ~ 500	0.01s
1088	0xBE	AF241	Brake Wait Time for Confirmation, 2nd-motor (Reverse side)	UINT	RW	0 ~ 500	0.01s
1088	0xBF	AF242	Brake Release Frequency Setting, 2nd-motor (Reverse side)	UINT	RW	0 ~ 59000	0.01Hz
1088	0xC0	AF243	Brake Release Current Setting, 2nd-motor (Reverse side)	UINT	RW	(0~2.00)*CTL Rated current	0.1A
1088	0xC1	AF244	Braking Frequency, 2nd-motor (Reverse side)	UINT	RW	0 ~ 59000	0.01Hz
1088	0xC7	AF250	Brake open delay time, 2nd-motor	UINT	RW	0 ~ 200	0.01s

Index	Sub-index	Func code	Function name	Type	Access	Setting Items	Data resolution· units
1088	0xC8	AF251	Brake close delay time, 2nd-motor	UINT	RW	0 ~ 200	0.01s
1088	0xC9	AF252	Brake answer back check time, 2nd-motor	UINT	RW	0 ~ 500	0.01s
1088	0xCA	AF253	Servo lock/ DC injection time at start, 2nd-motor	UINT	RW	0 ~ 1000	0.01s
1088	0xCB	AF254	Servo lock/ DC injection time at stop, 2nd-motor	UINT	RW	0 ~ 1000	0.01s
1049	0x9C	AG101	Jump frequency 1, 1st-motor	UINT	RW	0 ~ 59000	0.01Hz
1049	0x9D	AG102	Jump frequency width 1, 1st-motor	UINT	RW	0 ~ 1000	0.01Hz
1049	0x9E	AG103	Jump frequency 2, 1st-motor	UINT	RW	0 ~ 59000	0.01Hz
1049	0x9F	AG104	Jump frequency width 2, 1st-motor	UINT	RW	0 ~ 1000	0.01Hz
1049	0xA0	AG105	Jump frequency 3, 1st-motor	UINT	RW	0 ~ 59000	0.01Hz
1049	0xA1	AG106	Jump frequency width 3, 1st-motor	UINT	RW	0 ~ 1000	0.01Hz
1049	0xA5	AG110	Acceleration stop frequency setting, 1st-motor	UINT	RW	0 ~ 59000	0.01Hz
1049	0xA6	AG111	Acceleration stop time setting, 1st-motor	UINT	RW	0 ~ 600	0.1s
1049	0xA7	AG112	Deceleration stop frequency setting, 1st-motor	UINT	RW	0 ~ 59000	0.01Hz
1049	0xA8	AG113	Deceleration stop time setting, 1st-motor	UINT	RW	0 ~ 600	0.1s
1049	0xAF	AG-20	Jogging frequency	UINT	RW	0 ~ 1000	0.01Hz
1049	0xB0	AG-21	Jogging stop mode selection	UINT	RW	0 ~ 5	1
1088	0xFA	AG201	Jump frequency 1, 2nd-motor	UINT	RW	0 - 59000	0.01Hz
1088	0xFB	AG202	Jump frequency width 1, 2nd-motor	UINT	RW	0 - 1000	0.01Hz
1088	0xFC	AG203	Jump frequency 2, 2nd-motor	UINT	RW	0 - 59000	0.01Hz
1088	0xFD	AG204	Jump frequency width 2, 2nd-motor	UINT	RW	0 - 1000	0.01Hz

Index	Sub-index	Func code	Function name	Type	Access	Setting Items	Data resolution · units
1088	0xFE	AG205	Jump frequency 3, 2nd-motor	UINT	RW	0 - 59000	0.01Hz
1089	0x1	AG206	Jump frequency width 3, 2nd-motor	UINT	RW	0 - 1000	0.01Hz
1089	0x5	AG210	Acceleration stop frequency setting, 2nd-motor	UINT	RW	0 - 59000	0.01Hz
1089	0x6	AG211	Acceleration stop time setting, 2nd-motor	UINT	RW	0 - 600	0.1s
1089	0x7	AG212	Deceleration stop frequency setting, 2nd-motor	UINT	RW	0 - 59000	0.01Hz
1089	0x8	AG213	Deceleration stop time setting, 2nd-motor	UINT	RW	0 - 600	0.1s
1050	0x2	AH-01	PID1 enable	UINT	RW	0 ~ 2	1
1050	0x3	AH-02	PID1 deviation inverse	UINT	RW	0 ~ 1	1
1050	0x4	AH-03	Unit selection for PID1	UINT	RW	0 ~ 58	1
1050	0x5	AH-04	PID1 scale( 0%) Adj.	UINT	RW	-10000 ~ 10000	1
1050	0x6	AH-05	PID1 scale(100%) Adj.	UINT	RW	-10000 ~ 10000	1
1050	0x7	AH-06	PID1 scale (point)	UINT	RW	0 ~ 4	1
1050	0x8	AH-07	Input source selection of Set-point for PID1	UINT	RW	0 ~ 13	1
2050	0xB	AH-10	Set-point-1 setting for PID1	UDINT	RW	-10000 - 10000	Depends on AH-06
2050	0xD	AH-12	PID1 Multi stage set-point 1 setting	UDINT	RW	-10000 - 10000	Depends on AH-06
2050	0xF	AH-14	PID1 Multi stage set-point 2 setting	UDINT	RW	-10000 - 10000	Depends on AH-06
2050	0x11	AH-16	PID1 Multi stage set-point 3 setting	UDINT	RW	-10000 - 10000	Depends on AH-06
2050	0x13	AH-18	PID1 Multi stage set-point 4 setting	UDINT	RW	-10000 - 10000	Depends on AH-06
2050	0x15	AH-20	PID1 Multi stage set-point 5 setting	UDINT	RW	-10000 - 10000	Depends on AH-06
2050	0x17	AH-22	PID1 Multi stage set-point 6 setting	UDINT	RW	-10000 - 10000	Depends on AH-06

Index	Sub-index	Func code	Function name	Type	Access	Setting Items	Data resolution· units
2050	0x19	AH-24	PID1 Multi stage set-point 7 setting	UDINT	RW	-10000 - 10000	Depends on AH-06
2050	0x1B	AH-26	PID1 Multi stage set-point 8 setting	UDINT	RW	-10000 - 10000	Depends on AH-06
2050	0x1D	AH-28	PID1 Multi stage set-point 9 setting	UDINT	RW	-10000 - 10000	Depends on AH-06
2050	0x1F	AH-30	PID1 Multi stage set-point 10 setting	UDINT	RW	-10000 - 10000	Depends on AH-06
2050	0x21	AH-32	PID1 Multi stage set-point 11 setting	UDINT	RW	-10000 - 10000	Depends on AH-06
2050	0x23	AH-34	PID1 Multi stage set-point 12 setting	UDINT	RW	-10000 - 10000	Depends on AH-06
2050	0x25	AH-36	PID1 Multi stage set-point 13 setting	UDINT	RW	-10000 - 10000	Depends on AH-06
2050	0x27	AH-38	PID1 Multi stage set-point 14 setting	UDINT	RW	-10000 - 10000	Depends on AH-06
2050	0x29	AH-40	PID1 Multi stage set-point 15 setting	UDINT	RW	-10000 - 10000	Depends on AH-06
1050	0x2B	AH-42	Input source selection of Set-point 2 for PID1	UINT	RW	0 - 13	1
2050	0x2D	AH-44	Set-point-2 setting for PID1	UDINT	RW	-10000 - 10000	Depends on AH-06
1050	0x2F	AH-46	Input source selection of Set-point 3 for PID1	UINT	RW	0 ~ 13	1
2050	0x31	AH-48	Set-point-2 setting for PID1	UDINT	RW	-10000 ~ 10000	Depends on AH-06
1050	0x33	AH-50	Calculation symbol selection of Set-point 1 for PID1	UINT	RW	1 ~ 6	1
1050	0x34	AH-51	Input source selection of Process data 1 for PID1	UINT	RW	0 ~ 13	1
1050	0x35	AH-52	Input source selection of Process data 2 for PID1	UINT	RW	0 ~ 13	1
1050	0x36	AH-53	Input source selection of Process data 3 for PID1	UINT	RW	0 ~ 13	1

Index	Sub-index	Func code	Function name	Type	Access	Setting Items	Data resolution· units
1050	0x37	AH-54	Calculation symbol selection of Process data for PID1	UINT	RW	1 ~ 10	1
1050	0x3D	AH-60	PID1 gain change method selection	UINT	RW	0 ~ 1	1
1050	0x3E	AH-61	PID1 proportional gain 1	UINT	RW	0 ~ 1000	0.1
1050	0x3F	AH-62	PID1 integral time constant 1	UINT	RW	0 ~ 36000	0.1s
1050	0x40	AH-63	PID1 derivative gain 1	UINT	RW	0 ~ 10000	0.01s
1050	0x41	AH-64	PID1 proportional gain 2	UINT	RW	0 ~ 1000	0.1
1050	0x42	AH-65	PID1 integral time constant 2	UINT	RW	0 ~ 36000	0.1s
1050	0x43	AH-66	PID1 derivative gain 2	UINT	RW	0 ~ 10000	0.01s
1050	0x44	AH-67	PID1 gain change time	UINT	RW	0 ~ 10000	1ms
1050	0x47	AH-70	PID feed-forward selection	UINT	RW	0 ~ 6	1
1050	0x48	AH-71	PID1 output range	UINT	RW	0 ~ 10000	0.01%
1050	0x49	AH-72	PID1 Deviation over level	UINT	RW	0 ~ 10000	0.01%
1050	0x4A	AH-73	PID1 Feedback compare signal turn-off level	UINT	RW	0 ~ 10000	0.01%
1050	0x4B	AH-74	PID1 Feedback compare signal turn-on level	UINT	RW	0 ~ 10000	0.01%
1050	0x4C	AH-75	PID soft start function enable	UINT	RW	0 ~ 1	1
1050	0x4D	AH-76	PID soft start target level	UINT	RW	0 ~ 10000	0.01%
2050	0x4F	AH-78	Acceleration time setting for PID soft start function	UDINT	RW	0 ~ 360000	0.01s
1050	0x51	AH-80	PID soft start time	UINT	RW	0 ~ 10000	0.01s
1050	0x52	AH-81	PID soft start error detection enable	UINT	RW	0 ~ 2	1
1050	0x53	AH-82	PID soft start error detection level	UINT	RW	0 ~ 10000	0.01%
1050	0x56	AH-85	PID sleep trigger selection	UINT	RW	0 ~ 2	1
1050	0x57	AH-86	PID sleep start level	UINT	RW	0 ~ 59000	0.01Hz



Index	Sub-index	Func code	Function name	Type	Access	Setting Items	Data resolution· units
1050	0x58	AH-87	PID sleep active time	UINT	RW	0 ~ 10000	0.01s
1050	0x59	AH-88	Setpoint boost before PID sleep enable	UINT	RW	0 ~ 1	1
1050	0x5A	AH-89	Setpoint boost time	UINT	RW	0 ~ 10000	0.01s
1050	0x5B	AH-90	Setpoint boost value	UINT	RW	0 ~ 10000	0.01%
1050	0x5C	AH-91	Minimum RUN time before PID sleep	UINT	RW	0 ~ 10000	0.01s
1050	0x5D	AH-92	Minimum active time of PID sleep	UINT	RW	0 ~ 10000	0.01s
1050	0x5E	AH-93	PID sleep trigger selection	UINT	RW	1 ~ 3	1
1050	0x5F	AH-94	PID wake start level	UINT	RW	0 ~ 10000	0.01%
1050	0x60	AH-95	PID wake start time	UINT	RW	0 ~ 10000	0.01s
1050	0x61	AH-96	PID wake start deviation value	UINT	RW	0 ~ 10000	0.01%
1050	0x66	AJ-01	PID2 enable	UINT	RW	0 ~ 2	1
1050	0x67	AJ-02	PID2 deviation inverse	UINT	RW	0 ~ 1	1
1050	0x68	AJ-03	PID2 unit selection	UINT	RW	0 ~ 58	1
1050	0x69	AJ-04	PID2 scale( 0%) Adj.	UINT	RW	-10000 ~ 10000	1
1050	0x6A	AJ-05	PID2 scale(100%) Adj.	UINT	RW	-10000 ~ 10000	1
1050	0x6B	AJ-06	PID2 scale (point)	UINT	RW	0 ~ 4	1
1050	0x6C	AJ-07	Input source selection of Set-point for PID2	UINT	RW	0 ~ 15	1
2050	0x6F	AJ-10	Set-point setting for PID2	UDINT	RW	-10000 ~ 10000	Depends on AH-06
1050	0x71	AJ-12	Input source selection of Process data for PID2	UINT	RW	0 ~ 13	1
1050	0x72	AJ-13	PID2 proportional gain	UINT	RW	0 ~ 1000	0.1
1050	0x73	AJ-14	PID2 integral time constant	UINT	RW	0 ~ 36000	0.1s
1050	0x74	AJ-15	PID2 derivative gain	UINT	RW	0 ~ 10000	0.01s
1050	0x75	AJ-16	PID2 output range	UINT	RW	0 ~ 10000	0.01%
1050	0x76	AJ-17	PID2 Deviation over level	UINT	RW	0 ~ 10000	0.01%

Index	Sub-index	Func code	Function name	Type	Access	Setting Items	Data resolution· units
1050	0x77	AJ-18	PID2 Feedback compare signal turn-off level	UINT	RW	0 ~ 10000	0.01%
1050	0x78	AJ-19	PID2 Feedback compare signal turn-on level	UINT	RW	0 ~ 10000	0.01%
1050	0x7A	AJ-21	PID3 enable	UINT	RW	0 ~ 2	1
1050	0x7B	AJ-22	PID3 deviation inverse	UINT	RW	0 ~ 1	1
1050	0x7C	AJ-23	PID3 unit selection	UINT	RW	0 ~ 58	1
1050	0x7D	AJ-24	PID3 scale( 0%) Adj.	UINT	RW	-10000 ~ 10000	1
1050	0x7E	AJ-25	PID3 scale(100%) Adj.	UINT	RW	-10000 ~ 10000	1
1050	0x7F	AJ-26	PID3 scale (point)	UINT	RW	0 ~ 4	1
1050	0x80	AJ-27	Input source selection of Set-point for PID3	UINT	RW	0 ~ 13	1
2050	0x83	AJ-30	Set-point setting for PID3	UDINT	RW	-10000 ~ 10000	Depends on AH-26
1050	0x85	AJ-32	Input source selection of Process data for PID3	UINT	RW	0 ~ 13	1
1050	0x86	AJ-33	PID3 proportional gain	UINT	RW	0 ~ 1000	0.1
1050	0x87	AJ-34	PID3 derivative gain	UINT	RW	0 ~ 36000	0.1s
1050	0x88	AJ-35	PID3 derivative gain	UINT	RW	0 ~ 10000	0.01s
1050	0x89	AJ-36	PID3 output range	UINT	RW	0 ~ 10000	0.01%
1050	0x8A	AJ-37	PID3 Deviation over level	UINT	RW	0 ~ 10000	0.01%
1050	0x8B	AJ-38	PID3 Feedback compare signal turn-off level	UINT	RW	0 ~ 10000	0.01%
1050	0x8C	AJ-39	PID3 Feedback compare signal turn-on level	UINT	RW	0 ~ 10000	0.01%
1050	0x8E	AJ-41	PID4 enable	UINT	RW	0 ~ 2	1
1050	0x8F	AJ-42	PID4 deviation inverse	UINT	RW	0 ~ 1	1
1050	0x90	AJ-43	PID4 unit selection	UINT	RW	0 ~ 58	1
1050	0x91	AJ-44	PID4 scale( 0%) Adj.	UINT	RW	-10000 ~ 10000	1
1050	0x92	AJ-45	PID4 scale(100%) Adj.	UINT	RW	-10000 ~ 10000	1
1050	0x93	AJ-46	PID4 scale (point)	UINT	RW	0 ~ 4	1

Index	Sub-index	Func code	Function name	Type	Access	Setting Items	Data resolution · units
1050	0x94	AJ-47	Input source selection of Set-point for PID4	UINT	RW	0 ~ 13	1
2050	0x97	AJ-50	Set-point setting for PID4	UDINT	RW	-10000 ~ 10000	Depends on AH-46
1050	0x99	AJ-52	Input source selection of Process data for PID4	UINT	RW	0 ~ 13	1
1050	0x9A	AJ-53	PID4 proportional gain	UINT	RW	0 ~ 1000	0.1
1050	0x9B	AJ-54	PID4 derivative gain	UINT	RW	0 ~ 36000	0.1s
1050	0x9C	AJ-55	PID4 derivative gain	UINT	RW	0 ~ 10000	0.01s
1050	0x9D	AJ-56	PID4 output range	UINT	RW	0 ~ 10000	0.01%
1050	0x9E	AJ-57	PID4 Deviation over level	UINT	RW	0 ~ 10000	0.01%
1050	0x9F	AJ-58	PID4 Feedback compare signal turn-off level	UINT	RW	0 ~ 10000	0.01%
1050	0xA0	AJ-59	PID4 Feedback compare signal turn-on level	UINT	RW	0 ~ 10000	0.01%

### 13.2.4 Code-b

Index	Sub-index	Func code	Function name	Type	Access	Setting Items	Data resolution · units
1051	0x30	bA101	Frequency limit selection, 1st-motor	UINT	RW	0 ~ 13	1
1051	0x31	bA102	Upper Frequency limit, 1st-motor	UINT	RW	0 ~ 59000	0.01Hz
1051	0x32	bA103	Lower Frequency limit, 1st-motor	UINT	RW	0 ~ 59000	0.01Hz
1051	0x39	bA110	Torque limit selection, 1st-motor	UINT	RW	0 ~ 11	1
1051	0x3A	bA111	TRQ limit mode 1st-motor	UINT	RW	0 ~ 1	1
1051	0x3B	bA112	Torque limit 1 (Forward driving), 1st-motor	UINT	RW	0 ~ 5000	0.1%
1051	0x3C	bA113	Torque limit 2 (Reverse regenerative), 1st-motor	UINT	RW	0 ~ 5000	0.1%

Index	Sub-index	Func code	Function name	Type	Access	Setting Items	Data resolution· units
1051	0x3D	bA114	Torque limit 3 (Reverse driving), 1st-motor	UINT	RW	0 ~ 5000	0.1%
1051	0x3E	bA115	Torque limit 4 (Forward regenerative), 1st-motor	UINT	RW	0 ~ 5000	0.1%
1051	0x3F	bA116	Torque limit LADSTOP selection, 1st-motor	UINT	RW	0 ~ 1	1
1051	0x43	bA120	Over current suppress enable, 1st-motor	UINT	RW	0 ~ 1	1
1051	0x44	bA121	Over current suppress Level, 1st-motor	UINT	RW	(0~2.00)*CTL Rated current	0.1A
1051	0x45	bA122	Overload restriction 1 mode selection, 1st-motor	UINT	RW	0 ~ 3	1
1051	0x46	bA123	Overload restriction 1 active level, 1st-motor	UINT	RW	(0.20~2.00)*CTL Rated current	0.1A
2051	0x47	bA124	Overload restriction 1 action time, 1st-motor	UDINT	RW	10 ~ 360000	0.01s
1051	0x49	bA126	Overload restriction 2 mode selection, 1st-motor	UINT	RW	0 ~ 3	1
1051	0x4A	bA127	Overload restriction 2 active level, 1st-motor	UINT	RW	(0.20~2.00)*CTL Rated current	0.1A
2051	0x4B	bA128	Overload restriction 2 Action time, 1st-motor	UDINT	RW	10 ~ 360000	0.01s
1051	0x4D	bA-30	Deceleration-stop at power failure	UINT	RW	0 ~ 3	1
1051	0x4E	bA-31	Decel.-stop at power failure starting voltage	UINT	RW	200V class: 0 ~ 4100 400V class: 0 ~ 8200	0.1Vdc
1051	0x4F	bA-32	Decel-stop at power failure control target level	UINT	RW	200V class: 0 ~ 4100 400V class: 0 ~ 8200	0.1Vdc
2051	0x51	bA-34	Decel-stop at power failure deceleration time	UDINT	RW	1 ~ 360000	0.01s

Index	Sub-index	Func code	Function name	Type	Access	Setting Items	Data resolution·units
1051	0x53	bA-36	Decel-stop at power failure freq. width at deceleration start	UINT	RW	0 ~ 1000	0.01Hz
1051	0x54	bA-37	Decel-stop at power failure DC-bus voltage constant control P-gain	UINT	RW	0 ~ 500	0.01
1051	0x55	bA-38	Decel-stop at power failure DC-bus voltage constant control I-gain	UINT	RW	0 ~ 15000	0.01s
1051	0x57	bA140	Over-voltage suppression enable, 1st-motor	UINT	RW	0 ~ 3	1
1051	0x58	bA141	Over-voltage suppression active level, 1st-motor	UINT	RW	200V class: 3300 ~ 4000 400V class: 6600 ~ 8000	0.1Vdc
2051	0x59	bA142	Over-voltage suppression action time, 1st-motor	UDINT	RW	0 ~ 360000	0.01s
1051	0x5B	bA144	DC bus constant control proportional gain, 1st-motor	UINT	RW	0 ~ 500	0.01
1051	0x5C	bA145	DC bus constant control integral gain, 1st-motor	UINT	RW	0 ~ 15000	0.01s
1051	0x5D	bA146	Over magnetization function selection, 1st_motor	UINT	RW	0 ~ 4	1
1051	0x5E	bA147	Over magnetization output filter time constant, 1st_motor	UINT	RW	0 ~ 100	0.01s
1051	0x5F	bA148	Over magnetization voltage gain, 1st_motor	UINT	RW	50 ~ 400	1%
1051	0x60	bA149	Over magnetization level setting, 1st_motor	UINT	RW	200V class: 3300 ~ 4000 400V class: 6600 ~ 8000	0.1Vdc
1051	0x6B	bA-60	Dynamic brake usage rate	UINT	RW	0 ~ 1000 (bA-63 と関連)	0.1%

Index	Sub-index	Func code	Function name	Type	Access	Setting Items	Data resolution· units
1051	0x6C	bA-61	Dynamic brake selection	UINT	RW	0 ~ 2	1
1051	0x6D	bA-62	Dynamic brake active level	UINT	RW	200V class: 3300 ~ 4000 400V class: 6600 ~ 8000	0.1Vdc
1051	0x6E	bA-63	Dynamic brake resistor value	UINT	RW	Resistance minimum value ~ 600.0	0.1Ω
1051	0x75	bA-70	Cooling FAN control method selection	UINT	RW	0 ~ 2	1
1051	0x76	bA-71	Clear FAN time data	UINT	RW	0 ~ 1	1
1090	0x8E	bA201	Frequency limit selection, 2nd motor	UINT	RW	0 ~ 13	1
1090	0x8F	bA202	Upper frequency limit, 2nd motor	UINT	RW	0 ~ 59000	0.01Hz
1090	0x90	bA203	Lower frequency limit, 2nd motor	UINT	RW	0 ~ 59000	0.01Hz
1090	0x97	bA210	Torque limit selection, 2nd-motor	UINT	RW	0 ~ 11	1
1090	0x98	bA211	TRQ limit mode_M2	UINT	RW	0 ~ 1	1
1090	0x99	bA212	Torque limit 1 (Forward driving), 2nd-motor	UINT	RW	0 ~ 5000	0.1%
1090	0x9A	bA213	Torque limit 2 (Reverse regenerative), 2nd-motor	UINT	RW	0 ~ 5000	0.1%
1090	0x9B	bA214	Torque limit 3 (Reverse driving), 2nd-motor	UINT	RW	0 ~ 5000	0.1%
1090	0x9C	bA215	Torque limit 4 (Forward regenerative), 2nd motor	UINT	RW	0 ~ 5000	0.1%
1090	0x9D	bA216	Torque limit LADSTOP selection, 2nd-motor	UINT	RW	0 ~ 1	1
1090	0xA1	bA220	Over current suppress enable, 2nd-motor	UINT	RW	0 ~ 1	1
1090	0xA2	bA221	Over current suppress Level, 2nd-motor	UINT	RW	(0-2.00)*CTL Rated current	0.1A
1090	0xA3	bA222	Overload restriction 1 mode selection, 2nd-motor	UINT	RW	0 ~ 3	1

Index	Sub-index	Func code	Function name	Type	Access	Setting Items	Data resolution· units
1090	0xA4	bA223	Overload restriction 1 active level, 2nd-motor	UINT	RW	(0.20-2.00)*CTL Rated current	0.1A
2090	0xA5	bA224	Overload restriction 1 action time, 2nd-motor	UDINT	RW	10 ~ 360000	0.01s
1090	0xA7	bA226	Overload restriction 2 mode selection, 2nd-motor	UINT	RW	0 ~ 3	1
1090	0xA8	bA227	Overload restriction 2 active level, 2nd-motor	UINT	RW	(0.20-2.00)*CTL Rated current	0.1A
2090	0xA9	bA228	Overload restriction 2 action time, 2nd-motor	UDINT	RW	10 ~ 360000	0.01s
1090	0xB5	bA240	Over-voltage suppression enable, 2nd-motor	UINT	RW	0 ~ 3	1
1090	0xB6	bA241	Over-voltage suppression active level, 2nd-motor	UINT	RW	200V class: 3300 ~ 4000 400V class: 6600 ~ 8000	0.1Vdc
2090	0xB7	bA242	Over-voltage suppression action time, 2nd-motor	UDINT	RW	0 ~ 360000	0.01s
1090	0xB9	bA244	DC bus constant control proportional gain, 2nd-motor	UINT	RW	0 ~ 500	0.01
1090	0xBA	bA245	DC bus constant control integral gain, 2nd-motor	UINT	RW	0 ~ 15000	0.01s
1090	0xBB	bA246	Over magnetization function selection, 2nd-motor	UINT	RW	0 ~ 4	1
1090	0xBC	bA247	Over magnetization output filter time constant, 2nd-motor	UINT	RW	0 ~ 100	0.01s
1090	0xBD	bA248	Over magnetization voltage gain, 2nd-motor	UINT	RW	50 ~ 400	1%

Index	Sub-index	Func code	Function name	Type	Access	Setting Items	Data resolution· units
1090	0xBE	bA249	Over magnetization level setting, 2nd-motor	UINT	RW	200V class: 3300 ~ 4000 400V class: 6600 ~ 8000	0.1Vdc
1051	0x94	bb101	Carrier speed setting, 1st-motor	UINT	RW	5 ~ 160 (Depend on the capacity and the load)	0.1kHz
1051	0x95	bb102	Sprinkle carrier pattern selection, 1st-motor	UINT	RW	0 ~ 3	1
1051	0x96	bb103	Automatic-carrier reduction selection, 1st-motor	UINT	RW	0 ~ 2	1
1051	0x9D	bb-10	Automatic error reset selection	UINT	RW	0 ~ 2	1
1051	0x9E	bb-11	Alarm signal selection at Automatic error reset is active	UINT	RW	0 ~ 1	1
1051	0x9F	bb-12	Automatic error reset wait time	UINT	RW	0 ~ 600	1s
1051	0xA0	bb-13	Automatic error reset number	UINT	RW	0 ~ 10	1
1051	0xA7	bb-20	The number of retries after instantaneous power failure	UINT	RW	0 ~ 16 / 255	1
1051	0xA8	bb-21	The number of retries after under voltage	UINT	RW	0 ~ 16 / 255	1
1051	0xA9	bb-22	The number of retries after over current	UINT	RW	0 ~ 5	1
1051	0xAA	bb-23	The number of retries after over voltag	UINT	RW	0 ~ 5	1
1051	0xAB	bb-24	Selection of restart mode @Instantaneous power failure/	UINT	RW	0 ~ 4	1
1051	0xAC	bb-25	Allowable under-voltage power failure time	UINT	RW	3 ~ 250	0.1s
1051	0xAD	bb-26	Retry wait time before motor restart	UINT	RW	3 ~ 1000	0.1s
1051	0xAE	bb-27	Instantaneous power failure/under-voltage trip alarm enable	UINT	RW	0 ~ 2	1



Index	Sub-index	Func code	Function name	Type	Access	Setting Items	Data resolution· units
1051	0xAF	bb-28	Selection of restart mode @over-current	UINT	RW	0 ~ 4	1
1051	0xB0	bb-29	Wait time of restart @over-current	UINT	RW	3 ~ 1000	0.1s
1051	0xB1	bb-30	Selection of restart mode @over-voltage	UINT	RW	0 ~ 4	1
1051	0xB2	bb-31	Wait time of restart @over-voltage	UINT	RW	3 ~ 1000	0.1s
1051	0xBB	bb-40	Restart mode after FRS release	UINT	RW	0 ~ 3	1
1051	0xBC	bb-41	Restart mode after RS release	UINT	RW	0 ~ 3	1
1051	0xBD	bb-42	Restart frequency threshold	UINT	RW	0 ~ 59000	0.01Hz
1051	0xBE	bb-43	Restart level of Active frequency matching	UINT	RW	(0.20-2.00)*CTL Rated current	0.1A
1051	0xBF	bb-44	Restart constant(speed) of Active Frequency matching	UINT	RW	10 ~ 3000	0.01s
1051	0xC0	bb-45	Restart constant(Voltage) of Active Frequency matching	UINT	RW	10 ~ 3000	0.01s
1051	0xC1	bb-46	OC-supress level of Active frequency matching	UINT	RW	(0-2.00)*CTL Rated current	0.1A
1051	0xC2	bb-47	Restart speed selection of Active frequency matching	UINT	RW	0 ~ 2	1
1051	0xCF	bb160	Over current detection level, 1st-motor	UINT	RW	(0.20-2.20)*ND Rated current	0.1A
1051	0xD0	bb-61	Power supply over voltage selection	UINT	RW	0 ~ 1	1
1051	0xD1	bb-62	Power supply over voltage level setting	UINT	RW	200V class: 3000 ~ 4100 400V class: 6000 ~ 8200	0.1Vdc
1051	0xD3	bb-64	Ground fault selection	UINT	RW	0 ~ 1	1
1051	0xD4	bb-65	Input phase loss enable	UINT	RW	0 ~ 1	1
1051	0xD5	bb-66	Output phase loss enable	UINT	RW	0 ~ 1	1

Index	Sub-index	Func code	Function name	Type	Access	Setting Items	Data resolution·units
1051	0xD6	bb-67	Output phase loss detection sensitivity	UINT	RW	1 ~ 100	1%
1051	0xD9	bb-70	Thermistor error level	UINT	RW	0 ~ 10000	1Ω
1051	0xE3	bb-80	Over speed detection level	UINT	RW	0 ~ 1500	0.1%
1051	0xE4	bb-81	Over speed detection time	UINT	RW	0 ~ 50	0.1s
1051	0xE5	bb-82	Speed deviation error mode selection	UINT	RW	0 ~ 1	1
1051	0xE6	bb-83	Speed deviation error detection level	UINT	RW	0 ~ 1000	0.1%
1051	0xE7	bb-84	Speed deviation error detection time	UINT	RW	0 ~ 50	0.1s
1051	0xE8	bb-85	Position deviation error mode selection	UINT	RW	0 ~ 1	1
1051	0xE9	bb-86	Position deviation error detection level	UINT	RW	0 ~ 65535 (*100pls)	1(*100pls)
1051	0xEA	bb-87	Position deviation error detection level	UINT	RW	0 ~ 50	0.1s
1090	0xF2	bb201	Carrier speed setting, 2nd-motor	UINT	RW	5 ~ 160 (Depend on the capacity and the load)	0.1kHz
1090	0xF3	bb202	Sprinkle carrier pattern selection, 2nd-motor	UINT	RW	0 ~ 3	1
1090	0xF4	bb203	Automatic-carrier reduction selection, 2nd-motor	UINT	RW	0 ~ 2	1
1091	0x2F	bb260	Over current detection level, 2nd-motor	UINT	RW	(0.20~2.20)*ND Rated current	0.1A
1052	0x3	bC110	Electronic thermal level setting, 1st-motor	UINT	RW	(0 ~ 3.00)*CTL Rated current	0.1A
1052	0x4	bC111	Electronic thermal characteristic selection, 1st-motor	UINT	RW	0 ~ 2	1
1052	0x5	bC112	Electronic thermal subtraction function enable, 1st-motor	UINT	RW	0 ~ 1	1

Index	Sub-index	Func code	Function name	Type	Access	Setting Items	Data resolution· units
1052	0x6	bC113	Electronic thermal Subtraction time, 1st-motor	UINT	RW	1 ~ 1000	1s
1052	0x7	bC-14	Electronic thermal counter memory selection at Power-off	UINT	RW	0 ~ 1	1
1052	0xD	bC120	Free electronic thermal frequency-1, 1st-motor	UINT	RW	0 ~ 59000 (bC122)	0.01Hz
1052	0xE	bC121	Free electronic thermal current-1, 1st-motor	UINT	RW	(0 ~ 3.00)*CTL Rated current	0.1A
1052	0xF	bC122	Free electronic thermal frequency-2, 1st-motor	UINT	RW	0 ~ 59000 (bC120 ~ bC124)	0.01Hz
1052	0x10	bC123	Free electronic thermal current-2, 1st-motor	UINT	RW	(0 ~ 3.00)*CTL Rated current	0.1A
1052	0x11	bC124	Free electronic thermal frequency-3, 1st-motor	UINT	RW	0(bC122)~ 59000	0.01Hz
1052	0x12	bC125	Free electronic thermal current-3, 1st-motor	UINT	RW	(0~3.00)*CTL Rated current	0.1A
1091	0x61	bC210	Electronic thermal level setting, 2nd-motor	UINT	RW	(0~3.00)*CTL Rated current	0.1A
1091	0x62	bC211	Electronic thermal characteristic selection, 2nd-motor	UINT	RW	0 ~ 2	1
1091	0x63	bC212	Electronic thermal Subtraction function enable, 2nd-motor	UINT	RW	0 ~ 1	1
1091	0x64	bC213	Electronic thermal Subtraction time, 2nd-motor	UINT	RW	1 ~ 1000	1s
1091	0x6B	bC220	Free electronic thermal frequency-1, 2nd-motor	UINT	RW	0 ~ 59000 (bC222)	0.01Hz

Index	Sub-index	Func code	Function name	Type	Access	Setting Items	Data resolution·units
1091	0x6C	bC221	Free electronic thermal current-1, 2nd-motor	UINT	RW	(0 ~ 3.00)*CTL Rated current	0.1A
1091	0x6D	bC222	Free electronic thermal frequency-2, 2nd-motor	UINT	RW	0 ~ 59000 (bC220 ~ bC224)	0.01Hz
1091	0x6E	bC223	Free electronic thermal current-2, 2nd-motor	UINT	RW	(0 ~ 3.00)*CTL Rated current	0.1A
1091	0x6F	bC224	Free electronic thermal frequency-3, 2nd-motor	UINT	RW	0(bC222) ~ 59000	0.01Hz
1091	0x70	bC225	Free electronic thermal current-3, 2nd-motor	UINT	RW	(0~3.00)*CTL Rated current	0.1A
1052	0x5E	bd-01	STO input display selection	UINT	RW	0 ~ 2	1
1052	0x5F	bd-02	STO input change time	UINT	RW	0 ~ 6000	0.01s
1052	0x60	bd-03	Display selection at STO input change time	UINT	RW	0 ~ 1	1
1052	0x61	bd-04	Action selection after STO input change time	UINT	RW	0 ~ 2	1

### 13.2.5 Code-C

Index	Sub-index	Func code	Function name	Type	Access	Setting Items	Data resolution·units
1055	0x20	CA-01	Input terminal [1] function	UINT	RW	0 ~ 110	1
1055	0x21	CA-02	Input terminal [2] function	UINT	RW	0 ~ 110	1
1055	0x22	CA-03	Input terminal [3] function	UINT	RW	0 ~ 110	1
1055	0x23	CA-04	Input terminal [4] function	UINT	RW	0 ~ 110	1
1055	0x24	CA-05	Input terminal [5] function	UINT	RW	0 ~ 110	1
1055	0x25	CA-06	Input terminal [6] function	UINT	RW	0 ~ 110	1
1055	0x26	CA-07	Input terminal [7] function	UINT	RW	0 ~ 110	1
1055	0x27	CA-08	Input terminal [8] function	UINT	RW	0 ~ 110	1

Index	Sub-index	Func code	Function name	Type	Access	Setting Items	Data resolution· units
1055	0x28	CA-09	Input terminal [9] function	UINT	RW	0 ~ 110	1
1055	0x29	CA-10	Input terminal [A] function	UINT	RW	0 ~ 110	1
1055	0x2A	CA-11	Input terminal [B] function	UINT	RW	0 ~ 110	1
1055	0x34	CA-21	Input terminal [1] active state	UINT	RW	0 ~ 1	1
1055	0x35	CA-22	Input terminal [2] active state	UINT	RW	0 ~ 1	1
1055	0x36	CA-23	Input terminal [3] active state	UINT	RW	0 ~ 1	1
1055	0x37	CA-24	Input terminal [4] active state	UINT	RW	0 ~ 1	1
1055	0x38	CA-25	Input terminal [5] active state	UINT	RW	0 ~ 1	1
1055	0x39	CA-26	Input terminal [6] active state	UINT	RW	0 ~ 1	1
1055	0x3A	CA-27	Input terminal [7] active state	UINT	RW	0 ~ 1	1
1055	0x3B	CA-28	Input terminal [8] active state	UINT	RW	0 ~ 1	1
1055	0x3C	CA-29	Input terminal [9] active state	UINT	RW	0 ~ 1	1
1055	0x3D	CA-30	Input terminal [A] active state	UINT	RW	0 ~ 1	1
1055	0x3E	CA-31	Input terminal [B] active state	UINT	RW	0 ~ 1	1
1055	0x48	CA-41	Input terminal [1] response time	UINT	RW	0 ~ 400	1ms
1055	0x49	CA-42	Input terminal [2] response time	UINT	RW	0 ~ 400	1ms
1055	0x4A	CA-43	Input terminal [3] response time	UINT	RW	0 ~ 400	1ms
1055	0x4B	CA-44	Input terminal [4] response time	UINT	RW	0 ~ 400	1ms
1055	0x4C	CA-45	Input terminal [5] response time	UINT	RW	0 ~ 400	1ms
1055	0x4D	CA-46	Input terminal [6] response time	UINT	RW	0 ~ 400	1ms
1055	0x4E	CA-47	Input terminal [7] response time	UINT	RW	0 ~ 400	1ms
1055	0x4F	CA-48	Input terminal [8] response time	UINT	RW	0 ~ 400	1ms
1055	0x50	CA-49	Input terminal [9] response time	UINT	RW	0 ~ 400	1ms
1055	0x51	CA-50	Input terminal [A] response time	UINT	RW	0 ~ 400	1ms
1055	0x52	CA-51	Input terminal [B] response time	UINT	RW	0 ~ 400	1ms

Index	Sub-index	Func code	Function name	Type	Access	Setting Items	Data resolution· units
1055	0x56	CA-55	Multistage speed/position determination time	UINT	RW	0 ~ 2000	1ms
1055	0x5B	CA-60	FUP/FDN overwrite target selection	UINT	RW	0 ~ 1	1
1055	0x5C	CA-61	FUP/FDN data save enable	UINT	RW	0 ~ 1	1
1055	0x5D	CA-62	FUP/FDN UDC selection	UINT	RW	0 ~ 1	1
2055	0x5F	CA-64	Acceleration time setting for FUP/FDN function	UDINT	RW	0 ~ 360000	0.01s
2055	0x61	CA-66	Deceleration time setting for FUP/FDN function	UDINT	RW	0 ~ 360000	0.01s
1055	0x65	CA-70	Speed reference source selection at [F-OP] is active	UINT	RW	1 ~ 16	1
1055	0x66	CA-71	RUN command source selection at [F-OP] is active	UINT	RW	0 ~ 6	1
1055	0x67	CA-72	Reset mode selection	UINT	RW	0 ~ 3	1
1055	0x70	CA-81	Encoder constant setting	UINT	RW	32 ~ 65535	1pls
1055	0x71	CA-82	Encoder position selection	UINT	RW	0 ~ 1	1
1055	0x72	CA-83	Motor gear ratio Numerator	UINT	RW	1 ~ 10000	1
1055	0x73	CA-84	Motor gear ratio Denominator	UINT	RW	1 ~ 10000	1
1055	0x79	CA-90	Pulse train detection object selection	UINT	RW	0 ~ 3	1
1055	0x7A	CA-91	Mode selection of pulse train input	UINT	RW	0 ~ 2	1
1055	0x7B	CA-92	Pulse train frequency Scale	UINT	RW	5 ~ 3200	0.01kHz
1055	0x7C	CA-93	Pulse train frequency Filter time constant	UINT	RW	1 ~ 200	0.01s
1055	0x7D	CA-94	Pulse train frequency Bias value	UINT	RW	-1000 ~ 1000	0.1%
1055	0x7E	CA-95	Pulse train frequency High Limit	UINT	RW	0 ~ 1000	0.1%

Index	Sub-index	Func code	Function name	Type	Access	Setting Items	Data resolution· units
1055	0x7F	CA-96	Pulse train frequency detection low level	UINT	RW	0 ~ 1000	0.1%
1055	0x80	CA-97	Comparing match output ON-level for Pulse count	UINT	RW	0 ~ 65535	1
1055	0x81	CA-98	Comparing match output OFF-level for Pulse count	UINT	RW	0 ~ 65535	1
1055	0x82	CA-99	Comparing match output Maximum value for Pulse count	UINT	RW	0 ~ 65535	1
1055	0x84	Cb-01	Filter time constant of Terminal Ai1	UINT	RW	1 ~ 500	1ms
1055	0x86	Cb-03	Start value of Terminal Ai1	UINT	RW	0 ~ 10000	0.01%
1055	0x87	Cb-04	End value of Terminal Ai1	UINT	RW	0 ~ 10000	0.01%
1055	0x88	Cb-05	Start rate of Terminal Ai1	UINT	RW	0 ~ 1000 (Cb-06)	0.1%
1055	0x89	Cb-06	End rate of Terminal Ai1	UINT	RW	(Cb-05) 0 ~ 1000	0.1%
1055	0x8A	Cb-07	Start point selection of Terminal Ai1	UINT	RW	0 ~ 1	1
1055	0x8E	Cb-11	Filter time constant of Terminal Ai2	UINT	RW	1 ~ 500	1ms
1055	0x90	Cb-13	Start value of Terminal Ai2	UINT	RW	0 ~ 10000	0.01%
1055	0x91	Cb-14	End value of Terminal Ai2	UINT	RW	0 ~ 10000	0.01%
1055	0x92	Cb-15	Start rate of Terminal Ai2	UINT	RW	0 ~ 1000 (Cb-16)	0.1%
1055	0x93	Cb-16	End rate of Terminal Ai2	UINT	RW	(Cb-15) 0 ~ 1000	0.1%
1055	0x94	Cb-17	Start point selection of Terminal Ai2	UINT	RW	0 ~ 1	1
1055	0x98	Cb-21	Filter time constant of Terminal Ai3	UINT	RW	1 ~ 500	1ms
1055	0x99	Cb-22	Terminal Ai3 selection	UINT	RW	0 ~ 2	1
1055	0x9A	Cb-23	Start value of Terminal Ai3	UINT	RW	-10000 ~ 10000	0.01%
1055	0x9B	Cb-24	End value of Terminal Ai3	UINT	RW	-10000 ~ 10000	0.01%
1055	0x9C	Cb-25	Start rate of Terminal Ai3	UINT	RW	-1000 ~ 1000 (Cb-26)	0.1%

Index	Sub-index	Func code	Function name	Type	Access	Setting Items	Data resolution· units
1055	0x9D	Cb-26	End rate of Terminal Ai3	UINT	RW	(Cb-25)-1000 ~ 1000	0.1%
1055	0xA1	Cb-30	Ai1 Voltage/Current zero-gain adjustment	UINT	RW	-10000 ~ 10000	0.01%
1055	0xA2	Cb-31	Ai1 Voltage/Current gain adjustment	UINT	RW	0 ~ 20000	0.01%
1055	0xA3	Cb-32	Ai2 Voltage/Current zero-gain adjustment	UINT	RW	-10000 ~ 10000	0.01%
1055	0xA4	Cb-33	Ai2 Voltage/Current gain adjustment	UINT	RW	0 ~ 20000	0.01%
1055	0xA5	Cb-34	Ai3 Voltage/Current zero-gain adjustment	UINT	RW	-10000 ~ 10000	0.01%
1055	0xA6	Cb-35	Ai3 Voltage gain adjustment	UINT	RW	0 ~ 20000	0.01%
1055	0xAB	Cb-40	Thermistor selection	UINT	RW	0 ~ 2	1
1055	0xAC	Cb-41	Thermistor gain adjustment	UINT	RW	0 ~ 10000	0.1
1055	0xB6	Cb-51	Filter time constant of Volume on keypad	UINT	RW	1 ~ 500	1ms
1055	0xB8	Cb-53	Start value of Volume on keypad	UINT	RW	0 ~ 10000	0.01%
1055	0xB9	Cb-54	End value of Volume on keypad	UINT	RW	0 ~ 10000	0.01%
1055	0xBA	Cb-55	Start rate of Volume on keypad	UINT	RW	0 ~ 1000 (Cb-56)	0.1%
1055	0xBB	Cb-56	End rate of Volume on keypad	UINT	RW	(Cb-55) 0 ~ 1000	0.1%
1055	0xBC	Cb-57	Start point selection of Volume on keypad	UINT	RW	0 ~ 1	1
1055	0xE8	CC-01	Output terminal [11] function	UINT	RW	0 ~ 93	1
1055	0xE9	CC-02	Output terminal [12] function	UINT	RW	0 ~ 93	1
1055	0xEA	CC-03	Output terminal [13] function	UINT	RW	0 ~ 93	1
1055	0xEB	CC-04	Output terminal [14] function	UINT	RW	0 ~ 93	1



Index	Sub-index	Func code	Function name	Type	Access	Setting Items	Data resolution·units
1055	0xEC	CC-05	Output terminal [15] function	UINT	RW	0 ~ 93	1
1055	0xED	CC-06	Relay output terminal [16] function	UINT	RW	0 ~ 93	1
1055	0xEE	CC-07	Relay output terminal [AL] function	UINT	RW	0 ~ 93	1
1055	0xF2	CC-11	Output terminal [11] active state	UINT	RW	0 ~ 1	1
1055	0xF3	CC-12	Output terminal [12] active state	UINT	RW	0 ~ 1	1
1055	0xF4	CC-13	Output terminal [13] active state	UINT	RW	0 ~ 1	1
1055	0xF5	CC-14	Output terminal [14] active state	UINT	RW	0 ~ 1	1
1055	0xF6	CC-15	Output terminal [15] active state	UINT	RW	0 ~ 1	1
1055	0xF7	CC-16	Output terminal [16] active state	UINT	RW	0 ~ 1	1
1055	0xF8	CC-17	Output terminal [AL] active state	UINT	RW	0 ~ 1	1
1055	0xFB	CC-20	Output terminal [11] on-delay time	UINT	RW	0 ~ 10000	0.01s
1055	0xFC	CC-21	Output terminal [11] off-delay time	UINT	RW	0 ~ 10000	0.01s
1055	0xFD	CC-22	Output terminal [12] on-delay time	UINT	RW	0 ~ 10000	0.01s
1055	0xFE	CC-23	Output terminal [12] off-delay time	UINT	RW	0 ~ 10000	0.01s
1056	0x1	CC-24	Output terminal [13] on-delay time	UINT	RW	0 ~ 10000	0.01s
1056	0x2	CC-25	Output terminal [13] off-delay time	UINT	RW	0 ~ 10000	0.01s
1056	0x3	CC-26	Output terminal [14] on-delay time	UINT	RW	0 ~ 10000	0.01s
1056	0x4	CC-27	Output terminal [14] off-delay time	UINT	RW	0 ~ 10000	0.01s
1056	0x5	CC-28	Output terminal [15] on-delay time	UINT	RW	0 ~ 10000	0.01s
1056	0x6	CC-29	Output terminal [15] off-delay time	UINT	RW	0 ~ 10000	0.01s
1056	0x7	CC-30	Output relay [16] on-delay time	UINT	RW	0 ~ 10000	0.01s

Index	Sub-index	Func code	Function name	Type	Access	Setting Items	Data resolution· units
1056	0x8	CC-31	Output relay [16] off-delay time	UINT	RW	0 ~ 10000	0.01s
1056	0x9	CC-32	Output relay [AL] on-delay time	UINT	RW	0 ~ 10000	0.01s
1056	0xA	CC-33	Output relay [AL] off-delay time	UINT	RW	0 ~ 10000	0.01s
1056	0x11	CC-40	Logical calculation target 1 selection of LOG1	UINT	RW	0 ~ 93	1
1056	0x12	CC-41	Logical calculation target 2 selection of LOG1	UINT	RW	0 ~ 93	1
1056	0x13	CC-42	Logical calculation symbol selection of LOG1	UINT	RW	0 ~ 2	1
1056	0x14	CC-43	Logical calculation target 1 selection of LOG2	UINT	RW	0 ~ 93	1
1056	0x15	CC-44	Logical calculation target 2 selection of LOG2	UINT	RW	0 ~ 93	1
1056	0x16	CC-45	Logical calculation symbol selection of LOG2	UINT	RW	0 ~ 2	1
1056	0x17	CC-46	Logical calculation target 1 selection of LOG3	UINT	RW	0 ~ 93	1
1056	0x18	CC-47	Logical calculation target 2 selection of LOG3	UINT	RW	0 ~ 93	1
1056	0x19	CC-48	Logical calculation symbol selection of LOG3	UINT	RW	0 ~ 2	1
1056	0x1A	CC-49	Logical calculation target 1 selection of LOG4	UINT	RW	0 ~ 93	1

Index	Sub-index	Func code	Function name	Type	Access	Setting Items	Data resolution· units
1056	0x1B	CC-50	Logical calculation target 2 selection of LOG4	UINT	RW	0 ~ 93	1
1056	0x1C	CC-51	Logical calculation symbol selection of LOG4	UINT	RW	0 ~ 2	1
1056	0x1D	CC-52	Logical calculation target 1 selection of LOG5	UINT	RW	0 ~ 93	1
1056	0x1E	CC-53	Logical calculation target 2 selection of LOG5	UINT	RW	0 ~ 93	1
1056	0x1F	CC-54	Logical calculation symbol selection of LOG5	UINT	RW	0 ~ 2	1
1056	0x20	CC-55	Logical calculation target 1 selection of LOG6	UINT	RW	0 ~ 93	1
1056	0x21	CC-56	Logical calculation target 2 selection of LOG6	UINT	RW	0 ~ 93	1
1056	0x22	CC-57	Logical calculation symbol selection of LOG6	UINT	RW	0 ~ 2	1
1056	0x23	CC-58	Logical calculation target 1 selection of LOG7	UINT	RW	0 ~ 93	1
1056	0x24	CC-59	Logical calculation target 2 selection of LOG7	UINT	RW	0 ~ 93	1
1056	0x25	CC-60	Logical calculation symbol selection of LOG7	UINT	RW	0 ~ 2	1
1056	0x4E	Cd-01	FM monitor output wave form selection	UINT	RW	0 ~ 1	1

Index	Sub-index	Func code	Function name	Type	Access	Setting Items	Data resolution· units
1056	0x4F	Cd-02	FM monitor output base frequency (at PWM output)	UINT	RW	0 ~ 3600	1Hz
1056	0x50	Cd-03	FM monitor output selection	UINT	RW	0 ~ 65535 (d,F-code register number)	1
1056	0x51	Cd-04	Ao1 monitor output selection	UINT	RW	0 ~ 65535 (d,F-code register number)	1
1056	0x52	Cd-05	Ao2 monitor output selection	UINT	RW	0 ~ 65535 (d,F-code register number)	1
1056	0x57	Cd-10	Analog monitor adjust mode enable	UINT	RW	0 ~ 1	1
1056	0x58	Cd-11	Filter time constant of FMmonitor	UINT	RW	1 ~ 500	1ms
1056	0x59	Cd-12	FM Data type selection	UINT	RW	0 ~ 1	1
1056	0x5A	Cd-13	FM monitor bias adjustment	UINT	RW	-1000 ~ 1000	0.1%
1056	0x5B	Cd-14	FM monitor gain adjustment	UINT	RW	-10000 ~ 10000	0.1%
1056	0x5C	Cd-15	Output level setting at FM monitor adjust mode	UINT	RW	-1000 ~ 1000	0.1%
1056	0x62	Cd-21	Filter time constant of Ao1 monitor	UINT	RW	1 ~ 500	1ms
1056	0x63	Cd-22	Ao1 Data type selection	UINT	RW	0 ~ 1	1
1056	0x64	Cd-23	Ao1 monitor bias adjustment	UINT	RW	-1000 ~ 1000	0.1%
1056	0x65	Cd-24	Ao1 monitor gain adjustment	UINT	RW	-10000 ~ 10000	0.1%
1056	0x66	Cd-25	Output level setting at Ao1 monitor adjust mode	UINT	RW	-1000 ~ 1000	0.1%
1056	0x6C	Cd-31	Filter time constant of Ao2 monitor	UINT	RW	1 ~ 500	1ms
1056	0x6D	Cd-32	Ao2 Data type selection	UINT	RW	0 ~ 1	1
1056	0x6E	Cd-33	Ao2 monitor bias adjustment	UINT	RW	-1000 ~ 1000	0.1%
1056	0x6F	Cd-34	Ao2 monitor gain adjustment	UINT	RW	-10000 ~ 10000	0.1%
1056	0x70	Cd-35	Output level setting at Ao2 monitor adjust mode	UINT	RW	-1000 ~ 1000	0.1%

Index	Sub-index	Func code	Function name	Type	Access	Setting Items	Data resolution· units
1056	0xB2	CE101	Low current signal output mode selection, 1st motor	UINT	RW	0 ~ 1	1
1056	0xB3	CE102	Low current detection level 1, 1st motor	UINT	RW	(0~2.00)*CTL Rated current	0.1A
1056	0xB4	CE103	Low current detection level 2, 1st motor	UINT	RW	(0~2.00)*CTL Rated current	0.1A
1056	0xB6	CE105	Over current signal output mode selection, 1st motor	UINT	RW	0 ~ 1	1
1056	0xB7	CE106	Over current detection level 1, 1st motor	UINT	RW	(0~2.00)*CTL Rated current	0.1A
1056	0xB8	CE107	Over current detection level 2, 1st motor	UINT	RW	(0~2.00)*CTL Rated current	0.1A
1056	0xBB	CE-10	Arrival frequency setting during acceleration 1	UINT	RW	0 ~ 59000	0.01Hz
1056	0xBC	CE-11	Arrival frequency setting during deceleration 1	UINT	RW	0 ~ 59000	0.01Hz
1056	0xBD	CE-12	Arrival frequency setting during acceleration 2	UINT	RW	0 ~ 59000	0.01Hz
1056	0xBE	CE-13	Arrival frequency setting during deceleration 2	UINT	RW	0 ~ 59000	0.01Hz
1056	0xC5	CE120	Over torque level (Forward driving), 1st motor	UINT	RW	0 ~ 5000	0.1%
1056	0xC6	CE121	Over torque level (Reverse regenerative), 1st motor	UINT	RW	0 ~ 5000	0.1%
1056	0xC7	CE122	Over torque level (Reverse driving), 1st motor	UINT	RW	0 ~ 5000	0.1%
1056	0xC8	CE123	Over torque level (Forward regenerative), 1st motor	UINT	RW	0 ~ 5000	0.1%
1056	0xCF	CE-30	Electronic thermal warning level (MTR)	UINT	RW	0 ~ 10000	0.01%
1056	0xD0	CE-31	Electronic thermal warning level (CTL)	UINT	RW	0 ~ 10000	0.01%
1056	0xD2	CE-33	Zero speed detection level	UINT	RW	0 ~ 10000	0.01Hz

Index	Sub-index	Func code	Function name	Type	Access	Setting Items	Data resolution·units
1056	0xD3	CE-34	Cooling FAN over-heat warning level	UINT	RW	0 ~ 200	1°C
2056	0xD5	CE-36	Accum.RUN(RNT)/Accum.Power-on(ONT) time setting	UDINT	RW	0 ~ 100000	1hr
1056	0xD9	CE-40	Window compareter for Ai1 higher level	UINT	RW	0 ~ 100	1%
1056	0xDA	CE-41	Window compareter for Ai1 lower level	UINT	RW	0 ~ 100	1%
1056	0xDB	CE-42	Window compareter for Ai1 hysteresis width	UINT	RW	0 ~ 10	1%
1056	0xDC	CE-43	Window compareter for Ai2 higher level	UINT	RW	0 ~ 100	1%
1056	0xDD	CE-44	Window compareter for Ai2 lower level	UINT	RW	0 ~ 100	1%
1056	0xDE	CE-45	Window compareter for Ai2 hysteresis width	UINT	RW	0 ~ 10	1%
1056	0xDF	CE-46	Window compareter for Ai3 higher level	UINT	RW	-100 ~ 100	1%
1056	0xE0	CE-47	Window compareter for Ai3 lower level	UINT	RW	-100 ~ 100	1%
1056	0xE1	CE-48	Window compareter for Ai3 hysteresis width	UINT	RW	0 ~ 10	1%
1056	0xE3	CE-50	Operation level at Ai1 disconnection	UINT	RW	0 ~ 100	1%
1056	0xE4	CE-51	Operation level selection at Ai1 disconnection	UINT	RW	0 ~ 2	1
1056	0xE5	CE-52	Operation level at Ai2 disconnection	UINT	RW	0 ~ 100	1%
1056	0xE6	CE-53	Operation level selection at Ai2 disconnection	UINT	RW	0 ~ 2	1
1056	0xE7	CE-54	Operation level at Ai3 disconnection	UINT	RW	-100 ~ 100	1%
1056	0xE8	CE-55	Operation level selection at Ai3 disconnection	UINT	RW	0 ~ 2	1

Index	Sub-index	Func code	Function name	Type	Access	Setting Items	Data resolution·units
1096	0x12	CE201	Low current signal output mode selection, 2nd-motor	UINT	RW	0 ~ 1	1
1096	0x13	CE202	Low current detection level 1, 2nd-motor	UINT	RW	(0-2.00)*CTL Rated current	0.1A
1096	0x14	CE203	Low current detection level 2, 2nd-motor	UINT	RW	(0-2.00)*CTL Rated current	0.1A
1096	0x16	CE205	Over current signal output mode selection, 2nd-motor	UINT	RW	0 ~ 1	1
1096	0x17	CE206	Over current detection level 1, 2nd-motor	UINT	RW	(0-2.00)*CTL Rated current	0.1A
1096	0x18	CE207	Over current detection level 2, 2nd-motor	UINT	RW	(0-2.00)*CTL Rated current	0.1A
1096	0x25	CE220	Over torque level (Forward driving), 2nd-motor	UINT	RW	0 ~ 5000	0.1%
1096	0x26	CE221	Over torque level (Reverse regenerative), 2nd-motor	UINT	RW	0 ~ 5000	0.1%
1096	0x27	CE222	Over torque level (Reverse driving), 2nd-motor	UINT	RW	0 ~ 5000	0.1%
1096	0x28	CE223	Over torque level (Forward regenerative), 2nd motor	UINT	RW	0 ~ 5000	0.1%
1057	0x18	CF-01	RS485 communication baud rate selection	UINT	RW	3 ~ 10	1
1057	0x19	CF-02	RS485 communication Node allocation	UINT	RW	1 ~ 247	1
1057	0x1A	CF-03	RS485 communication parity selection	UINT	RW	0 ~ 2	1
1057	0x1B	CF-04	RS485 communication stop-bit selection	UINT	RW	1 ~ 2	1
1057	0x1C	CF-05	RS485 communication error selection	UINT	RW	0 ~ 4	1
1057	0x1D	CF-06	RS485 communication timeout setting	UINT	RW	0 ~ 10000	0.01s

Index	Sub-index	Func code	Function name	Type	Access	Setting Items	Data resolution· units
1057	0x1E	CF-07	RS485 communication wait time setting	UINT	RW	0 ~ 1000	1ms
1057	0x1F	CF-08	RS485 communication mode selection	UINT	RW	1 ~ 3	1
1057	0x22	CF-11	Register data AVI ⇔% conversion function	UINT	RW	0 ~ 1	1
1057	0x2B	CF-20	EzCOM Start node No.	UINT	RW	1 ~ 8	1
1057	0x2C	CF-21	EzCOM End node No.	UINT	RW	1 ~ 8	1
1057	0x2D	CF-22	EzCOM Start method selection	UINT	RW	0 ~ 1	1
1057	0x2E	CF-23	EzCOM data size	UINT	RW	1 ~ 5	1
1057	0x2F	CF-24	EzCOM destination address 1	UINT	RW	1 ~ 247	1
1057	0x30	CF-25	EzCOM destination resister 1	UINT	RW	0 ~ 65535	1
1057	0x31	CF-26	EzCOM source resister 1	UINT	RW	0 ~ 65535	1
1057	0x32	CF-27	EzCOM destination address 2	UINT	RW	1 ~ 247	1
1057	0x33	CF-28	EzCOM destination resister 2	UINT	RW	0 ~ 65535	1
1057	0x34	CF-29	EzCOM source resister 2	UINT	RW	0 ~ 65535	1
1057	0x35	CF-30	EzCOM destination address 3	UINT	RW	1 ~ 247	1
1057	0x36	CF-31	EzCOM destination resister 3	UINT	RW	0 ~ 65535	1
1057	0x37	CF-32	EzCOM source resister 3	UINT	RW	0 ~ 65535	1
1057	0x38	CF-33	EzCOM destination address 4	UINT	RW	1 ~ 247	1
1057	0x39	CF-34	EzCOM destination resister 4	UINT	RW	0 ~ 65535	1
1057	0x3A	CF-35	EzCOM source resister 4	UINT	RW	0 ~ 65535	1
1057	0x3B	CF-36	EzCOM destination address 5	UINT	RW	1 ~ 247	1
1057	0x3C	CF-37	EzCOM destination resister 5	UINT	RW	0 ~ 65535	1



Index	Sub-index	Func code	Function name	Type	Access	Setting Items	Data resolution·units
1057	0x3D	CF-38	EzCOM source register 5	UINT	RW	0 ~ 65535	1
1057	0x49	CF-50	USB communication Node allocation	UINT	RW	1 ~ 247	1

### 13.2.6 Code-H

Index	Sub-index	Func code	Function name	Type	Access	Setting Items	Data resolution·units
1059	0x10	HA-01	Auto-tuning selection	UINT	RW	0 ~ 3	1
1059	0x11	HA-02	RUN command selection at Auto-tuning	UINT	RW	0 ~ 1	1
1059	0x12	HA-03	Online auto-tuning selection	UINT	RW	0 ~ 1	1
1059	0x19	HA110	Stabilization constant, 1st-motor	UINT	RW	0 ~ 1000	1%
1059	0x1E	HA115	Speed response, 1st-motor	UINT	RW	0 ~ 1000	1%
1059	0x23	HA120	ASR gain switching mode selection, 1st-motor	UINT	RW	0 ~ 1	1
1059	0x24	HA121	ASR gain switching time setting, 1st-motor	UINT	RW	0 ~ 10000	1ms
1059	0x25	HA122	ASR gain mapping intermediate speed 1, 1st-motor	UINT	RW	0 ~ 59000	0.01Hz
1059	0x26	HA123	ASR gain mapping intermediate speed 2, 1st-motor	UINT	RW	0 ~ 59000	0.01Hz
1059	0x27	HA124	ASR gain mapping Maximum speed, 1st-motor	UINT	RW	0 ~ 59000	0.01Hz
1059	0x28	HA125	ASR gain mapping P-gain 1, 1st-motor	UINT	RW	0 ~ 10000	0.1%
1059	0x29	HA126	ASR gain mapping I-gain 1, 1st-motor	UINT	RW	0 ~ 10000	0.1%

Index	Sub-index	Func code	Function name	Type	Access	Setting Items	Data resolution· units
1059	0x2A	HA127	ASR gain mapping P-gain 1 at P-control, 1st-motor	UINT	RW	0 ~ 10000	0.1%
1059	0x2B	HA128	ASR gain mapping P-gain 2, 1st-motor	UINT	RW	0 ~ 10000	0.1%
1059	0x2C	HA129	ASR gain mapping I-gain 2, 1st-motor	UINT	RW	0 ~ 10000	0.1%
1059	0x2D	HA130	ASR gain mapping P-gain 2 at P-control, 1st-motor	UINT	RW	0 ~ 10000	0.1%
1059	0x2E	HA131	ASR gain mapping P-gain 3, 1st-motor	UINT	RW	0 ~ 10000	0.1%
1059	0x2F	HA132	ASR gain mapping I-gain 3, 1st-motor	UINT	RW	0 ~ 10000	0.1%
1059	0x30	HA133	ASR gain mapping P-gain 4, 1st-motor	UINT	RW	0 ~ 10000	0.1%
1059	0x31	HA134	ASR gain mapping I-gain 4, 1st-motor	UINT	RW	0 ~ 10000	0.1%
1098	0x77	HA210	Stabilization constant, 2nd-motor	UINT	RW	0 ~ 1000	1%
1098	0x7C	HA215	Speed response, 2nd-motor	UINT	RW	0 ~ 1000	1%
1098	0x81	HA220	ASR gain switching mode selection, 2nd-motor	UINT	RW	0 ~ 1	1
1098	0x82	HA221	ASR gain switching time setting, 2nd-motor	UINT	RW	0 ~ 10000	1ms
1098	0x83	HA222	ASR gain mapping intermediate speed 1, 2nd-motor	UINT	RW	0 ~ 59000	0.01Hz
1098	0x84	HA223	ASR gain mapping intermediate speed 2, 2nd-motor	UINT	RW	0 ~ 59000	0.01Hz
1098	0x85	HA224	ASR gain mapping Maximum speed, 2nd-motor	UINT	RW	0 ~ 59000	0.01Hz

Index	Sub-index	Func code	Function name	Type	Access	Setting Items	Data resolution· units
1098	0x86	HA225	ASR gain mapping P-gain 1, 2nd-motor	UINT	RW	0 ~ 10000	0.1%
1098	0x87	HA226	ASR gain mapping I-gain 1, 2nd-motor	UINT	RW	0 ~ 10000	0.1%
1098	0x88	HA227	ASR gain mapping P-gain 1 at P-control, 2nd-motor	UINT	RW	0 ~ 10000	0.1%
1098	0x89	HA228	ASR gain mapping P-gain 2, 2nd-motor	UINT	RW	0 ~ 10000	0.1%
1098	0x8A	HA229	ASR gain mapping I-gain 2, 2nd-motor	UINT	RW	0 ~ 10000	0.1%
1098	0x8B	HA230	ASR gain mapping P-gain 2 at P-control, 2nd-motor	UINT	RW	0 ~ 10000	0.1%
1098	0x8C	HA231	ASR gain mapping P-gain 3, 2nd-motor	UINT	RW	0 ~ 10000	0.1%
1098	0x8D	HA232	ASR gain mapping I-gain 3, 2nd-motor	UINT	RW	0 ~ 10000	0.1%
1098	0x8E	HA233	ASR gain mapping P-gain 4, 2nd-motor	UINT	RW	0 ~ 10000	0.1%
1098	0x8F	HA234	ASR gain mapping I-gain 4, 2nd-motor	UINT	RW	0 ~ 10000	0.1%
1059	0x75	Hb102	Async.Motor capacity setting, 1st-motor	UINT	RW	1 ~ 16000	0.01kW
1059	0x76	Hb103	Async.Motor Pole number setting, 1st-motor	UINT	RW	0 ~ 23	1
1059	0x77	Hb104	Async.Motor Base frequency setting, 1st-motor	UINT	RW	1000 ~ 59000	0.01Hz
1059	0x78	Hb105	Async.Motor Maximum frequency setting, 1st-motor	UINT	RW	1000 ~ 59000	0.01Hz
1059	0x79	Hb106	Async.Motor rated voltage, 1st-motor	UINT	RW	1 ~ 1000	1V
2059	0x7B	Hb108	Async.Motor rated current, 1st-motor	UDINT	RW	1 ~ 1000000	0.01A

Index	Sub-index	Func code	Function name	Type	Access	Setting Items	Data resolution · units
2059	0x7D	Hb110	Async.Motor constant R1, 1st-motor	UDINT	RW	1 ~ 1000000000	0.000001 Ω
2059	0x7F	Hb112	Async.Motor constant R2, 1st-motor	UDINT	RW	1 ~ 1000000000	0.000001 Ω
2059	0x81	Hb114	Async.Motor constant L, 1st-motor	UDINT	RW	1 ~ 1000000000	0.000001mH
2059	0x83	Hb116	Async.Motor constant I <sub>o</sub> , 1st-motor	UDINT	RW	1 ~ 1000000	0.01A
2059	0x85	Hb118	Async.Motor constant J, 1st-motor	UDINT	RW	1 ~ 1000000000	0.00001kg·m <sup>2</sup>
1059	0x91	Hb130	Minimum frequency adjustment, 1st-motor	UINT	RW	10 ~ 1000	0.01Hz
1059	0x92	Hb131	Reduced voltage start time setting, 1st-motor	UINT	RW	0 ~ 2000	1ms
1059	0x9B	Hb140	Manual torque boost operational mode selection, 1st-motor	UINT	RW	0 ~ 3	1
1059	0x9C	Hb141	Manual torque boost value, 1st-motor	UINT	RW	0 ~ 200	0.1%
1059	0x9D	Hb142	Manual torque boost Peak speed, 1st-motor	UINT	RW	0 ~ 500	0.1%
1059	0xA0	Hb145	Eco drive enable, 1st-motor	UINT	RW	0 ~ 1	1
1059	0xA1	Hb146	Eco drive response adjustment, 1st-motor	UINT	RW	0 ~ 100	1%
1059	0xA5	Hb150	Free-V/f frequency 1 setting, 1st-motor	UINT	RW	0 ~ 59000 (Hb152)	0.01Hz
1059	0xA6	Hb151	Free-V/f Voltage 1 setting, 1st-motor	UINT	RW	0 ~ 10000	0.1V
1059	0xA7	Hb152	Free-V/f frequency 2 setting, 1st-motor	UINT	RW	0 ~ 59000 (Hb150)~(Hb154)	0.01Hz
1059	0xA8	Hb153	Free-V/f Voltage 2 setting, 1st-motor	UINT	RW	0 ~ 10000	0.1V

Index	Sub-index	Func code	Function name	Type	Access	Setting Items	Data resolution· units
1059	0xA9	Hb154	Free-V/f frequency 3 setting, 1st-motor	UINT	RW	0 ~ 59000 (Hb152)~(Hb156)	0.01Hz
1059	0xAA	Hb155	Free-V/f Voltage 3 setting, 1st-motor	UINT	RW	0 ~ 10000	0.1V
1059	0xAB	Hb156	Free-V/f frequency 4 setting, 1st-motor	UINT	RW	0 ~ 59000 (Hb154)~(Hb158)	0.01Hz
1059	0xAC	Hb157	Free-V/f Voltage 4 setting, 1st-motor	UINT	RW	0 ~ 10000	0.1V
1059	0xAD	Hb158	Free-V/f frequency 5 setting, 1st-motor	UINT	RW	0 ~ 59000 (Hb156)~(Hb160)	0.01Hz
1059	0xAE	Hb159	Free-V/f Voltage 5 setting, 1st-motor	UINT	RW	0 ~ 10000	0.1V
1059	0xAF	Hb160	Free-V/f frequency 6 setting, 1st-motor	UINT	RW	0 ~ 59000 (Hb158)~(Hb162)	0.01Hz
1059	0xB0	Hb161	Free-V/f Voltage 6 setting, 1st-motor	UINT	RW	0 ~ 10000	0.1V
1059	0xB1	Hb162	Free-V/f frequency 7 setting, 1st-motor	UINT	RW	0 ~ 59000 (Hb160)~(Hb164)	0.01Hz
1059	0xB2	Hb163	Free-V/f Voltage 7 setting, 1st-motor	UINT	RW	0 ~ 10000	0.1V
1059	0xB9	Hb170	Slip Compensation P-gain with encoder, 1st-motor	UINT	RW	0 ~ 1000	1%
1059	0xBA	Hb171	Slip Compensation I-gain with encoder, 1st-motor	UINT	RW	0 ~ 1000	1%
1059	0xC3	Hb180	Output voltage gain, 1st-motor	UINT	RW	0 ~ 255	1%
1098	0xD3	Hb202	Async.Motor capacity setting, 2nd-motor	UINT	RW	1 ~ 16000	0.01kW
1098	0xD4	Hb203	Async.Motor Pole number setting, 2nd-motor	UINT	RW	0 ~ 23	1

Index	Sub-index	Func code	Function name	Type	Access	Setting Items	Data resolution · units
1098	0xD5	Hb204	Async.Motor Base frequency setting, 2nd-motor	UINT	RW	1000 ~ 59000	0.01Hz
1098	0xD6	Hb205	Async.Motor Maximum frequency setting, 2nd-motor	UINT	RW	1000 ~ 59000	0.01Hz
1098	0xD7	Hb206	Async.Motor rated voltage, 2nd-motor	UINT	RW	1 ~ 1000	1V
2098	0xD9	Hb208	Async.Motor rated current, 2nd-motor	UDINT	RW	1 ~ 1000000	0.01A
2098	0xDB	Hb210	Async.Motor constant R1, 2nd-motor	UDINT	RW	1 ~ 1000000000	0.000001 Ω
2098	0xDD	Hb212	Async.Motor constant R2, 2nd-motor	UDINT	RW	1 ~ 1000000000	0.000001 Ω
2098	0xDF	Hb214	Async.Motor constant L, 2nd-motor	UDINT	RW	1 ~ 1000000000	0.000001m H
2098	0xE1	Hb216	Async.Motor constant I <sub>o</sub> , 2nd-motor	UDINT	RW	1 ~ 1000000	0.01A
2098	0xE3	Hb218	Async.Motor constant J, 2nd-motor	UDINT	RW	1 ~ 1000000000	0.00001kg · m <sup>2</sup>
1098	0xEF	Hb230	Minimum frequency adjustment, 2nd-motor	UINT	RW	10 ~ 1000	0.01Hz
1098	0xF0	Hb231	Reduced voltage start time setting, 2nd-motor	UINT	RW	0 ~ 2000	1ms
1098	0xF9	Hb240	Manual torque boost operational mode selection, 2nd-motor	UINT	RW	0 ~ 3	1
1098	0xFA	Hb241	Manual torque boost value, 2nd-motor	UINT	RW	0 ~ 200	0.1%
1098	0xFB	Hb242	Manual torque boost Peak speed, 2nd-motor	UINT	RW	0 ~ 500	0.1%
1098	0xFE	Hb245	Eco drive enable, 2nd-motor	UINT	RW	0 ~ 1	1
1099	0x1	Hb246	Eco drive response adjustment, 2nd-motor	UINT	RW	0 ~ 100	1%

Index	Sub-index	Func code	Function name	Type	Access	Setting Items	Data resolution· units
1099	0x5	Hb250	Free-V/f frequency 1 setting, 2nd-motor	UINT	RW	0 ~ 59000 (Hb252)	0.01Hz
1099	0x6	Hb251	Free-V/f Voltage 1 setting, 2nd-motor	UINT	RW	0 ~ 10000	0.1V
1099	0x7	Hb252	Free-V/f frequency 2 setting, 2nd-motor	UINT	RW	0 ~ 59000 (Hb250)~(Hb254)	0.01Hz
1099	0x8	Hb253	Free-V/f Voltage 2 setting, 2nd-motor	UINT	RW	0 ~ 10000	0.1V
1099	0x9	Hb254	Free-V/f frequency 3 setting, 2nd-motor	UINT	RW	0 ~ 59000 (Hb252)~(Hb256)	0.01Hz
1099	0xA	Hb255	Free-V/f Voltage 3 setting, 2nd-motor	UINT	RW	0 ~ 10000	0.1V
1099	0xB	Hb256	Free-V/f frequency 4 setting, 2nd-motor	UINT	RW	0 ~ 59000 (Hb254)~(Hb258)	0.01Hz
1099	0xC	Hb257	Free-V/f Voltage 4 setting, 2nd-motor	UINT	RW	0 ~ 10000	0.1V
1099	0xD	Hb258	Free-V/f frequency 5 setting, 2nd-motor	UINT	RW	0 ~ 59000 (Hb256)~(Hb260)	0.01Hz
1099	0xE	Hb259	Free-V/f Voltage 5 setting, 2nd-motor	UINT	RW	0 ~ 10000	0.1V
1099	0xF	Hb260	Free-V/f frequency 6 setting, 2nd-motor	UINT	RW	0 ~ 59000 (Hb258)~(Hb262)	0.01Hz
1099	0x10	Hb261	Free-V/f Voltage 6 setting, 2nd-motor	UINT	RW	0 ~ 10000	0.1V
1099	0x11	Hb262	Free-V/f frequency 7 setting, 2nd-motor	UINT	RW	0 ~ 59000 (Hb260)~(Hb204)	0.01Hz
1099	0x12	Hb263	Free-V/f Voltage 7 setting, 2nd-motor	UINT	RW	0 ~ 10000	0.1V
1099	0x19	Hb270	Slip Compensation P-gain with encoder, 2nd-motor	UINT	RW	0 ~ 1000	1%

Index	Sub-index	Func code	Function name	Type	Access	Setting Items	Data resolution· units
1099	0x1A	Hb271	Slip Compensation I-gain with encoder, 2nd-motor	UINT	RW	0 ~ 1000	1%
1099	0x23	Hb280	Output voltage gain, 2nd-motor	UINT	RW	0 ~ 255	1%
1059	0xD8	HC101	Automatic torque boost voltage compensation gain, 1st-motor	UINT	RW	0 ~ 255	1%
1059	0xD9	HC102	Automatic torque boost slip compensation gain, 1st-motor	UINT	RW	0 ~ 255	1%
1059	0xE1	HC110	Zero speed area limit for Async.M-OSLV, 1st-motor	UINT	RW	0 ~ 100	1%
1059	0xE2	HC111	Boost value at start, 1st-motor	UINT	RW	0 ~ 50	1%
1059	0xE3	HC112	Boost value at start for Async.M-OSLV, 1st-motor	UINT	RW	0 ~ 50	1%
1059	0xE4	HC113	Secondary resistance correction, 1st-motor	UINT	RW	0 ~ 1	1
1059	0xE5	HC114	Counter direction run protection selection, 1st-motor	UINT	RW	0 ~ 1	1
1059	0xEB	HC120	Torque current reference filter time constant, 1st-motor	UINT	RW	0 ~ 100	1ms
1059	0xEC	HC121	Speed feedforward compensation gain, 1st-motor	UINT	RW	0 ~ 1000	1%
1099	0x38	HC201	Automatic torque boost voltage compensation gain, 2nd-motor	UINT	RW	0 ~ 255	1%
1099	0x39	HC202	Automatic torque boost slip compensation gain, 2nd-motor	UINT	RW	0 ~ 255	1%
1099	0x41	HC210	Zero speed area limit for Async.M-OSLV, 2nd-motor	UINT	RW	0 ~ 100	1%



Index	Sub-index	Func code	Function name	Type	Access	Setting Items	Data resolution· units
1099	0x42	HC211	Boost value at start, 2nd-motor	UINT	RW	0 ~ 50	1%
1099	0x43	HC212	Boost value at start for Async.M-OSLV, 2nd-motor	UINT	RW	0 ~ 50	1%
1099	0x44	HC213	Secondary resistance correction, 2nd-motor	UINT	RW	0 ~ 1	1
1099	0x45	HC214	Counter direction run protection selection, 2nd-motor	UINT	RW	0 ~ 1	1
1099	0x4B	HC220	Torque current reference filter time constant, 2nd-motor	UINT	RW	0 ~ 100	1ms
1099	0x4C	HC221	Speed feedforward compensation gain, 2nd-motor	UINT	RW	0 ~ 1000	1%
1060	0x3F	Hd102	Sync.Motor capacity setting, 1st-motor	UINT	RW	1 ~ 16000	0.01kW
1060	0x40	Hd103	Sync.Motor Pole number setting, 1st-motor	UINT	RW	0 ~ 23	1
1060	0x41	Hd104	Sync.Base frequency setting, 1st-motor	UINT	RW	1000 ~ 59000	0.01Hz
1060	0x42	Hd105	Sync.Maximum frequency setting, 1st-motor	UINT	RW	1000 ~ 59000	0.01Hz
1060	0x43	Hd106	Sync.Motor rated voltage, 1st-motor	UINT	RW	1 ~ 1000	1V
2060	0x45	Hd108	Sync.Motor rated current, 1st-motor	UDINT	RW	1 ~ 1000000	0.01A
2060	0x47	Hd110	Sync.Motor constant R, 1st-motor	UDINT	RW	1 ~ 1000000000	0.000001Ω
2060	0x49	Hd112	Sync.Motor constant Ld, 1st-motor	UDINT	RW	1 ~ 1000000000	0.000001mH
2060	0x4B	Hd114	Sync.Motor constant Lq, 1st-motor	UDINT	RW	1 ~ 1000000000	0.000001mH
2060	0x4D	Hd116	Sync.Motor constant Ke, 1st-motor	UDINT	RW	1 ~ 1000000	0.1mVs/rad

Index	Sub-index	Func code	Function name	Type	Access	Setting Items	Data resolution· units
2060	0x4F	Hd118	Sync.Motor constant J, 1st-motor	UDINT	RW	1 ~ 1000000000	0.00001 kg·m <sup>2</sup>
1060	0x5B	Hd130	Minimum Frequency for Sync.M-SLV, 1st-motor	UINT	RW	0 ~ 50	1%
1060	0x5C	Hd131	No-Load current for Sync.M-SLV, 1st-motor	UINT	RW	0 ~ 100	1%
1060	0x5D	Hd132	Starting Method for Sync.M, 1st-motor	UINT	RW	0 ~ 1	1
1060	0x5E	Hd133	IMPE 0V wait number for Sync.M, 1st-motor	UINT	RW	0 ~ 255	1
1060	0x5F	Hd134	IMPE detect wait number for Sync.M, 1st-motor	UINT	RW	0 ~ 255	1
1060	0x60	Hd135	IMPE detect number for Sync.M, 1st-motor	UINT	RW	0 ~ 255	1
1060	0x61	Hd136	IMPE voltage gain for Sync.M, 1st-motor	UINT	RW	0 ~ 200	1%
1060	0x62	Hd137	IMPE Mg-pole position offset, 1st-motor	UINT	RW	0 ~ 359	1deg
1060	0x66	Hd-41	Carrier frequency at IVMS	UINT	RW	5 ~ 160	0.1kHz
1060	0x67	Hd-42	Filter gain of current detection at IVMS	UINT	RW	0 ~ 1000	1
1060	0x68	Hd-43	Open phase voltage detection gain, 1st-motor	UINT	RW	0 ~ 3	1
1060	0x69	Hd-44	Open phase switching threshold compensation	UINT	RW	0 ~ 1	1
1060	0x6A	Hd-45	P-Gain for speed control, SM(PMM)-IVMS	UINT	RW	0 ~ 1000	1
1060	0x6B	Hd-46	I-Gain for speed control, SM(PMM)-IVMS	UINT	RW	0 ~ 10000	1

Index	Sub-index	Func code	Function name	Type	Access	Setting Items	Data resolution· units
1060	0x6C	Hd-47	Wait time for open phase switching, SM(PMM)-IVMS	UINT	RW	0 ~ 1000	1
1060	0x6D	Hd-48	Limitation of decision about the drive direction, SM(PMM)-IVMS	UINT	RW	0 ~ 1	1
1060	0x6E	Hd-49	Open phase voltage detection timing adjustment, SM(PMM)-IVMS	UINT	RW	0 ~ 1000	1
1060	0x6F	Hd-50	Minimum pulse width adjustment, SM(PMM)-IVMS	UINT	RW	0 ~ 1000	1
1060	0x70	Hd-51	IVMS Current Limit	UINT	RW	0 ~ 255	1
1060	0x71	Hd-52	IVMS Threshold Gain	UINT	RW	0 ~ 255	1
1060	0x77	Hd-58	IVMSfc start/end point	UINT	RW	0 ~ 50	1%
1099	0x9D	Hd202	Sync.Motor capacity setting, 2nd-motor	UINT	RW	1 ~ 16000	0.01kW
1099	0x9E	Hd203	Sync.Motor Pole number setting, 2nd-motor	UINT	RW	0 ~ 23	1
1099	0x9F	Hd204	Sync.Base frequency setting, 2nd-motor	UINT	RW	1000 ~ 59000	0.01Hz
1099	0xA0	Hd205	Sync.Maximum frequency setting, 2nd-motor	UINT	RW	1000 ~ 59000	0.01Hz
1099	0xA1	Hd206	Sync.Motor rated voltage, 2nd-motor	UINT	RW	1 ~ 1000	1V
2099	0xA3	Hd208	Sync.Motor rated current, 2nd-motor	UDINT	RW	1 ~ 1000000	0.01A
2099	0xA5	Hd210	Sync.Motor constant R, 2nd-motor	UDINT	RW	1 ~ 1000000000	0.000001 Ω
2099	0xA7	Hd212	Sync.Motor constant Ld, 2nd-motor	UDINT	RW	1 ~ 1000000000	0.000001m H
2099	0xA9	Hd214	Sync.Motor constant Lq, 2nd-motor	UDINT	RW	1 ~ 1000000000	0.000001m H

Index	Sub-index	Func code	Function name	Type	Access	Setting Items	Data resolution·units
2099	0xAB	Hd216	Sync.Motor constant Ke, 2nd-motor	UDINT	RW	1 ~ 1000000	0.1mVs/rad
2099	0xAD	Hd218	Sync.Motor constant J, 2nd-motor	UDINT	RW	1 ~ 1000000000	0.00001 kg·m <sup>2</sup>
1099	0xB9	Hd230	Minimum Frequency for Sync.M-SLV, 2nd-motor	UINT	RW	0 ~ 50	1%
1099	0xBA	Hd231	No-Load current for Sync.M-SLV, 2nd-motor	UINT	RW	0 ~ 100	1%
1099	0xBB	Hd232	Starting Method for Sync.M, 2nd-motor	UINT	RW	0 ~ 1	1
1099	0xBC	Hd233	IMPE 0V wait number for Sync.M, 2nd-motor	UINT	RW	0 ~ 255	1
1099	0xBD	Hd234	IMPE detect wait number for Sync.M, 2nd-motor	UINT	RW	0 ~ 255	1
1099	0xBE	Hd235	IMPE detect number for Sync.M, 2nd-motor	UINT	RW	0 ~ 255	1
1099	0xBF	Hd236	IMPE voltage gain for Sync.M, 2nd-motor	UINT	RW	0 ~ 200	1%
1099	0xC0	Hd237	IMPE Mg-pole position offset, 2nd-motor	UINT	RW	0 ~ 359	1deg

### 13.2.7 Code-o

Index	Sub-index	Func code	Function name	Type	Access	Setting Items	Data resolution·units
1063	0x9	oA-10	Operation mode on option card error (SLOT-1)	UINT	RW	0 ~ 1	1
1063	0xA	oA-11	Communication Watch Dog Timer (SLOT-1)	UINT	RW	0 ~ 10000	0.01s
1063	0xB	oA-12	Action selection at communication error (SLOT-1)	UINT	RW	0 ~ 4	1
1063	0xC	oA-13	Run command sel(OP)1	UINT	RW	0 ~ 1	1

Index	Sub-index	Func code	Function name	Type	Access	Setting Items	Data resolution· units
1063	0x13	oA-20	Operation mode on option card error (SLOT-2)	UINT	RW	0 ~ 1	1
1063	0x14	oA-21	Communication Watch Dog Timer (SLOT-2)	UINT	RW	0 ~ 10000	0.01s
1063	0x15	oA-22	Action selection at communication error (SLOT-2)	UINT	RW	0 ~ 4	1
1063	0x16	oA-23	Run command sel(OP)2	UINT	RW	0 ~ 1	1
1063	0x1D	oA-30	Operation mode on option card error (SLOT-3)	UINT	RW	0 ~ 1	1
1063	0x1E	oA-31	Communication Watch Dog Timer (SLOT-3)	UINT	RW	0 ~ 10000	0.01s
1063	0x1F	oA-32	Action selection at communication error (SLOT-3)	UINT	RW	0 ~ 4	1
1063	0x20	oA-33	Run command sel(OP)3	UINT	RW	0 ~ 1	1
1063	0x64	ob-01	Encoder constant setting	UINT	RW	32 ~ 65535	1pls
1063	0x65	ob-02	Encoder position selection	UINT	RW	0 ~ 1	1
1063	0x66	ob-03	CH1 Motor gear ratio Numerator	UINT	RW	1 ~ 10000	1
1063	0x67	ob-04	CH1 Motor gear ratio Denominator	UINT	RW	1 ~ 10000	1
1063	0x6D	ob-10	Pulse train detection object selection	UINT	RW	0 ~ 1	1
1063	0x6E	ob-11	Mode selection of pulse train input	UINT	RW	0 ~ 2	1
1063	0x6F	ob-12	Pulse train frequency Scale	UINT	RW	5 ~ 20000	0.01kHz
1063	0x70	ob-13	Pulse train frequency Filter time constant	UINT	RW	1 ~ 200	0.01s
1063	0x71	ob-14	Pulse train frequency Bias value	UINT	RW	-1000 ~ 1000	0.1%
1063	0x72	ob-15	Pulse train frequency High Limit	UINT	RW	0 ~ 1000	0.1%
1063	0x73	ob-16	Pulse train frequency detection low level	UINT	RW	0 ~ 1000	0.1%

Index	Sub-index	Func code	Function name	Type	Access	Setting Items	Data resolution· units
1063	0xC8	oC-01	Safety option input display selection	UINT	RW	0 ~ 1	1
2063	0xD1	oC-10	SS1-A deceleration time setting	UDINT	RW	0 ~ 360000	0.01s
2063	0xD3	oC-12	SLS-A deceleration time setting	UDINT	RW	0 ~ 360000	0.01s
1063	0xD5	oC-14	SLS-A Speed upper limit(Forward)	UINT	RW	0 ~ 59000	0.01Hz
1063	0xD6	oC-15	SLS-A Speed upper limit(Reverse)	UINT	RW	0 ~ 59000	0.01Hz
2063	0xD7	oC-16	SDI-A deceleration time setting	UDINT	RW	0 ~ 360000	0.01s
1063	0xD9	oC-18	SDI-A limited direction	UINT	RW	0 ~ 1	1
2063	0xDB	oC-20	SS1-B deceleration time setting	UDINT	RW	0 ~ 360000	0.01s
2063	0xDD	oC-22	SLS-B deceleration time setting	UDINT	RW	0 ~ 360000	0.01s
1063	0xDF	oC-24	SLS-B Speed upper limit(Forward)	UINT	RW	0 ~ 59000	0.01Hz
1063	0xE0	oC-25	SLS-B Speed upper limit(Reverse)	UINT	RW	0 ~ 59000	0.01Hz
2063	0xE1	oC-26	SDI-B deceleration time setting	UDINT	RW	0 ~ 360000	0.01s
1063	0xE3	oC-28	SDI-B limited direction	UINT	RW	0 ~ 1	1
1064	0x92	oE-01	Filter time constant of Terminal [Ai4]	UINT	RW	1 ~ 500	1ms
1064	0x94	oE-03	Start value of Terminal [Ai4]	UINT	RW	0 ~ 10000	0.01%
1064	0x95	oE-04	End value of Terminal [Ai4]	UINT	RW	0 ~ 10000	0.01%
1064	0x96	oE-05	Start rate of Terminal [Ai4]	UINT	RW	0 ~ 1000 (oE-06)	0.1%
1064	0x97	oE-06	End rate of Terminal [Ai4]	UINT	RW	(oE-05) 0 ~ 1000	0.1%
1064	0x98	oE-07	Start point selection of Terminal [Ai6]	UINT	RW	0 ~ 1	1
1064	0x9C	oE-11	Filter time constant of Terminal [Ai5]	UINT	RW	1 ~ 500	1ms

Index	Sub-index	Func code	Function name	Type	Access	Setting Items	Data resolution· units
1064	0x9E	oE-13	Start value of Terminal [Ai5]	UINT	RW	0 ~ 10000	0.01%
1064	0x9F	oE-14	End value of Terminal [Ai5]	UINT	RW	0 ~ 10000	0.01%
1064	0xA0	oE-15	Start rate of Terminal [Ai5]	UINT	RW	0 ~ 1000 (oE-16)	0.1%
1064	0xA1	oE-16	End rate of Terminal [Ai5]	UINT	RW	(oE-15) 0 ~ 1000	0.1%
1064	0xA2	oE-17	Start point selection of Terminal [Ai5]	UINT	RW	0 ~ 1	1
1064	0xA6	oE-21	Filter time constant of Terminal [Ai6]	UINT	RW	1 ~ 500	1ms
1064	0xA8	oE-23	Start value of Terminal [Ai6]	UINT	RW	-10000 ~ 10000	0.01%
1064	0xA9	oE-24	End value of Terminal [Ai6]	UINT	RW	-10000 ~ 10000	0.01%
1064	0xAA	oE-25	Start rate of Terminal [Ai6]	UINT	RW	-1000 ~ 1000 (oE-26)	0.1%
1064	0xAB	oE-26	End rate of Terminal [Ai6]	UINT	RW	(oE-25) -1000 ~ 1000	0.1%
1064	0xAD	oE-28	Ai4 Voltage/Current zero-gain adjustment	UINT	RW	-10000 ~ 10000	0.01%
1064	0xAE	oE-29	Ai4 Voltage/Current gain adjustment	UINT	RW	0 ~ 20000	0.01%
1064	0xAF	oE-30	Ai5 Voltage/Current zero-gain adjustment	UINT	RW	-10000 ~ 10000	0.01%
1064	0xB0	oE-31	Ai5 Voltage/Current gain adjustment	UINT	RW	0 ~ 20000	0.01%
1064	0xB1	oE-32	Ai6 Voltage zero-gain adjustment	UINT	RW	-10000 ~ 10000	0.01%
1064	0xB2	oE-33	Ai6 Voltage gain adjustment	UINT	RW	0 ~ 20000	0.01%
1064	0xB4	oE-35	Window compareter for [Ai4] higher level	UINT	RW	0 ~ 100	1%
1064	0xB5	oE-36	Window compareter for [Ai4] lower level	UINT	RW	0 ~ 100	1%
1064	0xB6	oE-37	Window compareter for [Ai4] hysteresis width	UINT	RW	0 ~ 10	1%
1064	0xB7	oE-38	Window compareter for [Ai5] higher level	UINT	RW	0 ~ 100	1%

Index	Sub-index	Func code	Function name	Type	Access	Setting Items	Data resolution· units
1064	0xB8	oE-39	Window compareter for [Ai5] lower level	UINT	RW	0 ~ 100	1%
1064	0xB9	oE-40	Window compareter for [Ai5] hysteresis width	UINT	RW	0 ~ 10	1%
1064	0xBA	oE-41	Window compareter for [Ai6] higher level	UINT	RW	-100 ~ 100	1%
1064	0xBB	oE-42	Window compareter for [Ai6] lower level	UINT	RW	-100 ~ 100	1%
1064	0xBC	oE-43	Window compareter for [Ai6] hysteresis width	UINT	RW	0 ~ 10	1%
1064	0xBD	oE-44	Operation level at [Ai4] disconnection	UINT	RW	0 ~ 100	1%
1064	0xBE	oE-45	Operation level selection at [Ai4] disconnection	UINT	RW	0 ~ 2	1
1064	0xBF	oE-46	Operation level at [Ai5] disconnection	UINT	RW	0 ~ 100	1%
1064	0xC0	oE-47	Operation level selection at [Ai5] disconnection	UINT	RW	0 ~ 2	1
1064	0xC1	oE-48	Operation level at [Ai6] disconnection	UINT	RW	-100 ~ 100	1%
1064	0xC2	oE-49	Operation level selection at [Ai6] disconnection	UINT	RW	0 ~ 2	1
1064	0xC3	oE-50	Ao3 monitor output selection	UINT	RW	0 ~ 65535 (register number)	1
1064	0xC4	oE-51	Ao4 monitor output selection	UINT	RW	0 ~ 65535 (register number)	1
1064	0xC5	oE-52	Ao5 monitor output selection	UINT	RW	0 ~ 65535 (register number)	1
1064	0xC9	oE-56	Filter time constant of [Ao3] monitor	UINT	RW	1 ~ 500	1ms
1064	0xCA	oE-57	Ao3 Data type selection	UINT	RW	0 ~ 1	1
1064	0xCB	oE-58	Ao3 monitor bias adjustment	UINT	RW	-1000 ~ 1000	0.1%
1064	0xCC	oE-59	Ao3 monitor gain adjustment	UINT	RW	-10000 ~ 10000	0.1%
1064	0xCD	oE-60	Output level setting at [Ao3] monitor adjust mode	UINT	RW	-1000 ~ 1000	0.1%



Index	Sub-index	Func code	Function name	Type	Access	Setting Items	Data resolution·units
1064	0xCE	oE-61	Filter time constant of [Ao4] monitor	UINT	RW	1 ~ 500	1ms
1064	0xCF	oE-62	Ao4 Data type selection	UINT	RW	0 ~ 1	1
1064	0xD0	oE-63	Ao4 monitor bias adjustment	UINT	RW	-1000 ~ 1000	0.1%
1064	0xD1	oE-64	Ao4 monitor gain adjustment	UINT	RW	-10000 ~ 10000	0.1%
1064	0xD2	oE-65	Output level setting at [Ao4] monitor adjust mode	UINT	RW	-1000 ~ 1000	0.1%
1064	0xD3	oE-66	Filter time constant of [Ao5] monitor	UINT	RW	1 ~ 500	1ms
1064	0xD4	oE-67	Ao5 Data type selection	UINT	RW	0 ~ 1	1
1064	0xD5	oE-68	Ao5 monitor bias adjustment	UINT	RW	-1000 ~ 1000	0.1%
1064	0xD6	oE-69	Ao5 monitor gain adjustment	UINT	RW	-10000 ~ 10000	0.1%
1064	0xD7	oE-70	Output level setting at [Ao5] monitor adjust mode	UINT	RW	-1000 ~ 1000	0.1%
1065	0xC0	oH-01	IP-Address selection(P1-EN)	UINT	RW	0 ~ 1	1
1065	0xC1	oH-02	Communication speed (port-1)(P1-EN)	UINT	RW	0 ~ 4	1
1065	0xC2	oH-03	Communication speed (port-2)(P1-EN)	UINT	RW	0 ~ 4	1
1065	0xC3	oH-04	Ethernet communication timeout(P1-EN)	UINT	RW	1 ~ 65535	1(*10ms)
1065	0xC4	oH-05	Modbus TCP Port No.(IPv4)	UINT	RW	502,1024 ~ 65535	1
1065	0xC5	oH-06	Modbus TCP Port No.(IPv6)	UINT	RW	502,1024 ~ 65535	1
1065	0xD3	oH-20	Profibus Node address	UINT	RW	0 ~ 125	1
1065	0xD4	oH-21	Profibus clear mode selection	UINT	RW	0 ~ 1	1
1065	0xD5	oH-22	Profibus Map selection	UINT	RW	0 ~ 2	1
1065	0xD6	oH-23	Setting enable from Profi master	UINT	RW	0 ~ 1	1
1065	0xD7	oH-24	Setpoint telegram/Actual value telegram Gr. Selection(P1-PB)	UINT	RW	0 ~ 2	1

Index	Sub-index	Func code	Function name	Type	Access	Setting Items	Data resolution· units
1065	0xDD	oH-30	IP-Address selection(P1-PN)	UINT	RW	0 ~ 1	1
1065	0xDE	oH-31	Communication speed (port-1)(P1-PN)	UINT	RW	0 ~ 4	1
1065	0xDF	oH-32	Communication speed (port-2)(P1-PN)	UINT	RW	0 ~ 4	1
1065	0xE0	oH-33	Ethernet communication timeout(P1-PN)	UINT	RW	1 ~ 65535	1(*10ms)
1065	0xE1	oH-34	Setpoint telegram/Actual value telegram Gr. Selection(P1-PN)	UINT	RW	0 ~ 2	1
1066	0x26	oJ-01	Flexible command registration writing register 1, Gr.A	UINT	RW	0 ~ 65535	1
1066	0x27	oJ-02	Flexible command registration writing register 2, Gr.A	UINT	RW	0 ~ 65535	1
1066	0x28	oJ-03	Flexible command registration writing register 3, Gr.A	UINT	RW	0 ~ 65535	1
1066	0x29	oJ-04	Flexible command registration writing register 4, Gr.A	UINT	RW	0 ~ 65535	1
1066	0x2A	oJ-05	Flexible command registration writing register 5, Gr.A	UINT	RW	0 ~ 65535	1
1066	0x2B	oJ-06	Flexible command registration writing register 6, Gr.A	UINT	RW	0 ~ 65535	1
1066	0x2C	oJ-07	Flexible command registration writing register 7, Gr.A	UINT	RW	0 ~ 65535	1

Index	Sub-index	Func code	Function name	Type	Access	Setting Items	Data resolution· units
1066	0x2D	oJ-08	Flexible command registration writing register 8, Gr.A	UINT	RW	0 ~ 65535	1
1066	0x2E	oJ-09	Flexible command registration writing register 9, Gr.A	UINT	RW	0 ~ 65535	1
1066	0x2F	oJ-10	Flexible command registration writing register 10, Gr.A	UINT	RW	0 ~ 65535	1
1066	0x30	oJ-11	Flexible command registration Reading register 1, Gr.A	UINT	RW	0 ~ 65535	1
1066	0x31	oJ-12	Flexible command registration Reading register 2, Gr.A	UINT	RW	0 ~ 65535	1
1066	0x32	oJ-13	Flexible command registration Reading register 3, Gr.A	UINT	RW	0 ~ 65535	1
1066	0x33	oJ-14	Flexible command registration Reading register 4, Gr.A	UINT	RW	0 ~ 65535	1
1066	0x34	oJ-15	Flexible command registration Reading register 5, Gr.A	UINT	RW	0 ~ 65535	1
1066	0x35	oJ-16	Flexible command registration Reading register 6, Gr.A	UINT	RW	0 ~ 65535	1
1066	0x36	oJ-17	Flexible command registration Reading register 7, Gr.A	UINT	RW	0 ~ 65535	1
1066	0x37	oJ-18	Flexible command registration Reading register 8, Gr.A	UINT	RW	0 ~ 65535	1

Index	Sub-index	Func code	Function name	Type	Access	Setting Items	Data resolution· units
1066	0x38	oJ-19	Flexible command registration Reading register 9, Gr.A	UINT	RW	0 ~ 65535	1
1066	0x39	oJ-20	Flexible command registration Reading register 10, Gr.A	UINT	RW	0 ~ 65535	1
1066	0x3A	oJ-21	Flexible command registration writing register 1, Gr.B	UINT	RW	0 ~ 65535	1
1066	0x3B	oJ-22	Flexible command registration writing register 2, Gr.B	UINT	RW	0 ~ 65535	1
1066	0x3C	oJ-23	Flexible command registration writing register 3, Gr.B	UINT	RW	0 ~ 65535	1
1066	0x3D	oJ-24	Flexible command registration writing register 4, Gr.B	UINT	RW	0 ~ 65535	1
1066	0x3E	oJ-25	Flexible command registration writing register 5, Gr.B	UINT	RW	0 ~ 65535	1
1066	0x3F	oJ-26	Flexible command registration writing register 6, Gr.B	UINT	RW	0 ~ 65535	1
1066	0x40	oJ-27	Flexible command registration writing register 7, Gr.B	UINT	RW	0 ~ 65535	1
1066	0x41	oJ-28	Flexible command registration writing register 8, Gr.B	UINT	RW	0 ~ 65535	1
1066	0x42	oJ-29	Flexible command registration writing register 9, Gr.B	UINT	RW	0 ~ 65535	1

Index	Sub-index	Func code	Function name	Type	Access	Setting Items	Data resolution· units
1066	0x43	oJ-30	Flexible command registration writing register 10, Gr.B	UINT	RW	0 ~ 65535	1
1066	0x44	oJ-31	Flexible command registration Reading register 1, Gr.B	UINT	RW	0 ~ 65535	1
1066	0x45	oJ-32	Flexible command registration Reading register 2, Gr.B	UINT	RW	0 ~ 65535	1
1066	0x46	oJ-33	Flexible command registration Reading register 3, Gr.B	UINT	RW	0 ~ 65535	1
1066	0x47	oJ-34	Flexible command registration Reading register 4, Gr.B	UINT	RW	0 ~ 65535	1
1066	0x48	oJ-35	Flexible command registration Reading register 5, Gr.B	UINT	RW	0 ~ 65535	1
1066	0x49	oJ-36	Flexible command registration Reading register 6, Gr.B	UINT	RW	0 ~ 65535	1
1066	0x4A	oJ-37	Flexible command registration Reading register 7, Gr.B	UINT	RW	0 ~ 65535	1
1066	0x4B	oJ-38	Flexible command registration Reading register 8, Gr.B	UINT	RW	0 ~ 65535	1
1066	0x4C	oJ-39	Flexible command registration Reading register 9, Gr.B	UINT	RW	0 ~ 65535	1
1066	0x4D	oJ-40	Flexible command registration Reading register 10, Gr.B	UINT	RW	0 ~ 65535	1

Index	Sub-index	Func code	Function name	Type	Access	Setting Items	Data resolution· units
1066	0x4E	oJ-41	Flexible command registration writing register 1, Gr.C	UINT	RW	0 ~ 65535	1
1066	0x4F	oJ-42	Flexible command registration writing register 2, Gr.C	UINT	RW	0 ~ 65535	1
1066	0x50	oJ-43	Flexible command registration writing register 3, Gr.C	UINT	RW	0 ~ 65535	1
1066	0x51	oJ-44	Flexible command registration writing register 4, Gr.C	UINT	RW	0 ~ 65535	1
1066	0x52	oJ-45	Flexible command registration writing register 5, Gr.C	UINT	RW	0 ~ 65535	1
1066	0x53	oJ-46	Flexible command registration writing register 6, Gr.C	UINT	RW	0 ~ 65535	1
1066	0x54	oJ-47	Flexible command registration writing register 7, Gr.C	UINT	RW	0 ~ 65535	1
1066	0x55	oJ-48	Flexible command registration writing register 8, Gr.C	UINT	RW	0 ~ 65535	1
1066	0x56	oJ-49	Flexible command registration writing register 9, Gr.C	UINT	RW	0 ~ 65535	1
1066	0x57	oJ-50	Flexible command registration writing register 10, Gr.C	UINT	RW	0 ~ 65535	1
1066	0x58	oJ-51	Flexible command registration Reading register 1, Gr.C	UINT	RW	0 ~ 65535	1

Index	Sub-index	Func code	Function name	Type	Access	Setting Items	Data resolution· units
1066	0x59	oJ-52	Flexible command registration Reading register 2, Gr.C	UINT	RW	0 ~ 65535	1
1066	0x5A	oJ-53	Flexible command registration Reading register 3, Gr.C	UINT	RW	0 ~ 65535	1
1066	0x5B	oJ-54	Flexible command registration Reading register 4, Gr.C	UINT	RW	0 ~ 65535	1
1066	0x5C	oJ-55	Flexible command registration Reading register 5, Gr.C	UINT	RW	0 ~ 65535	1
1066	0x5D	oJ-56	Flexible command registration Reading register 6, Gr.C	UINT	RW	0 ~ 65535	1
1066	0x5E	oJ-57	Flexible command registration Reading register 7, Gr.C	UINT	RW	0 ~ 65535	1
1066	0x5F	oJ-58	Flexible command registration Reading register 8, Gr.C	UINT	RW	0 ~ 65535	1
1066	0x60	oJ-59	Flexible command registration Reading register 9, Gr.C	UINT	RW	0 ~ 65535	1
1066	0x61	oJ-60	Flexible command registration Reading register 10, Gr.C	UINT	RW	0 ~ 65535	1
1066	0x8A	oL-01	IPv4 IP address (1), Gr.1	UINT	RW	0 ~ 255	1
1066	0x8B	oL-02	IPv4 IP address (2), Gr.1	UINT	RW	0 ~ 255	1
1066	0x8C	oL-03	IPv4 IP address (3), Gr.1	UINT	RW	0 ~ 255	1
1066	0x8D	oL-04	IPv4 IP address (4), Gr.1	UINT	RW	0 ~ 255	1
1066	0x8E	oL-05	IPv4 Sub-net mask (1), Gr.1	UINT	RW	0 ~ 255	1

Index	Sub-index	Func code	Function name	Type	Access	Setting Items	Data resolution·units
1066	0x8F	oL-06	IPv4 Sub-net mask (2), Gr.1	UINT	RW	0 ~ 255	1
1066	0x90	oL-07	IPv4 Sub-net mask (3), Gr.1	UINT	RW	0 ~ 255	1
1066	0x91	oL-08	IPv4 Sub-net mask (4), Gr.1	UINT	RW	0 ~ 255	1
1066	0x92	oL-09	IPv4 Default gateway (1), Gr.1	UINT	RW	0 ~ 255	1
1066	0x93	oL-10	IPv4 Default gateway (2), Gr.1	UINT	RW	0 ~ 255	1
1066	0x94	oL-11	IPv4 Default gateway (3), Gr.1	UINT	RW	0 ~ 255	1
1066	0x95	oL-12	IPv4 Default gateway (4), Gr.1	UINT	RW	0 ~ 255	1
1066	0x9D	oL-20	IPv6 IP address (1), Gr.1	UINT	RW	0 ~ 65535	1
1066	0x9E	oL-21	IPv6 IP address (2), Gr.1	UINT	RW	0 ~ 65535	1
1066	0x9F	oL-22	IPv6 IP address (3), Gr.1	UINT	RW	0 ~ 65535	1
1066	0xA0	oL-23	IPv6 IP address (4), Gr.1	UINT	RW	0 ~ 65535	1
1066	0xA1	oL-24	IPv6 IP address (5), Gr.1	UINT	RW	0 ~ 65535	1
1066	0xA2	oL-25	IPv6 IP address (6), Gr.1	UINT	RW	0 ~ 65535	1
1066	0xA3	oL-26	IPv6 IP address (7), Gr.1	UINT	RW	0 ~ 65535	1
1066	0xA4	oL-27	IPv6 IP address (8), Gr.1	UINT	RW	0 ~ 65535	1
1066	0xA5	oL-28	IPv6 Prefix of Sub-net, Gr.1	UINT	RW	0 ~ 127	1
1066	0xA6	oL-29	IPv6 Default gateway (1), Gr.1	UINT	RW	0 ~ 65535	1
1066	0xA7	oL-30	IPv6 Default gateway (2), Gr.1	UINT	RW	0 ~ 65535	1
1066	0xA8	oL-31	IPv6 Default gateway (3), Gr.1	UINT	RW	0 ~ 65535	1
1066	0xA9	oL-32	IPv6 Default gateway (4), Gr.1	UINT	RW	0 ~ 65535	1
1066	0xAA	oL-33	IPv6 Default gateway (5), Gr.1	UINT	RW	0 ~ 65535	1
1066	0xAB	oL-34	IPv6 Default gateway (6), Gr.1	UINT	RW	0 ~ 65535	1
1066	0xAC	oL-35	IPv6 Default gateway (7), Gr.1	UINT	RW	0 ~ 65535	1
1066	0xAD	oL-36	IPv6 Default gateway (8), Gr.1	UINT	RW	0 ~ 65535	1
1066	0xB1	oL-40	IPv4 IP address (1), Gr.2	UINT	RW	0 ~ 255	1
1066	0xB2	oL-41	IPv4 IP address (2), Gr.2	UINT	RW	0 ~ 255	1
1066	0xB3	oL-42	IPv4 IP address (3), Gr.2	UINT	RW	0 ~ 255	1



Index	Sub-index	Func code	Function name	Type	Access	Setting Items	Data resolution·units
1066	0xB4	oL-43	IPv4 IP address (4), Gr.2	UINT	RW	0 ~ 255	1
1066	0xB5	oL-44	IPv4 Sub-net mask (1), Gr.2	UINT	RW	0 ~ 255	1
1066	0xB6	oL-45	IPv4 Sub-net mask (2), Gr.2	UINT	RW	0 ~ 255	1
1066	0xB7	oL-46	IPv4 Sub-net mask (3), Gr.2	UINT	RW	0 ~ 255	1
1066	0xB8	oL-47	IPv4 Sub-net mask (4), Gr.2	UINT	RW	0 ~ 255	1
1066	0xB9	oL-48	IPv4 Default gateway (1), Gr.2	UINT	RW	0 ~ 255	1
1066	0xBA	oL-49	IPv4 Default gateway (2), Gr.2	UINT	RW	0 ~ 255	1
1066	0xBB	oL-50	IPv4 Default gateway (3), Gr.2	UINT	RW	0 ~ 255	1
1066	0xBC	oL-51	IPv4 Default gateway (4), Gr.2	UINT	RW	0 ~ 255	1
1066	0xC5	oL-60	IPv6 IP address (1), Gr.2	UINT	RW	0 ~ 65535	1
1066	0xC6	oL-61	IPv6 IP address (2), Gr.2	UINT	RW	0 ~ 65535	1
1066	0xC7	oL-62	IPv6 IP address (3), Gr.2	UINT	RW	0 ~ 65535	1
1066	0xC8	oL-63	IPv6 IP address (4), Gr.2	UINT	RW	0 ~ 65535	1
1066	0xC9	oL-64	IPv6 IP address (5), Gr.2	UINT	RW	0 ~ 65535	1
1066	0xCA	oL-65	IPv6 IP address (6), Gr.2	UINT	RW	0 ~ 65535	1
1066	0xCB	oL-66	IPv6 IP address (7), Gr.2	UINT	RW	0 ~ 65535	1
1066	0xCC	oL-67	IPv6 IP address (8), Gr.2	UINT	RW	0 ~ 65535	1
1066	0xCD	oL-68	IPv6 Prefix of Sub-net, Gr.2	UINT	RW	0 ~ 127	1
1066	0xCE	oL-69	IPv6 Default gateway (1), Gr.2	UINT	RW	0 ~ 65535	1
1066	0xCF	oL-70	IPv6 Default gateway (2), Gr.2	UINT	RW	0 ~ 65535	1
1066	0xD0	oL-71	IPv6 Default gateway (3), Gr.2	UINT	RW	0 ~ 65535	1
1066	0xD1	oL-72	IPv6 Default gateway (4), Gr.2	UINT	RW	0 ~ 65535	1
1066	0xD2	oL-73	IPv6 Default gateway (5), Gr.2	UINT	RW	0 ~ 65535	1
1066	0xD3	oL-74	IPv6 Default gateway (6), Gr.2	UINT	RW	0 ~ 65535	1
1066	0xD4	oL-75	IPv6 Default gateway (7), Gr.2	UINT	RW	0 ~ 65535	1
1066	0xD5	oL-76	IPv6 Default gateway (8), Gr.2	UINT	RW	0 ~ 65535	1

## 13.2.8 Code-P

Index	Sub-index	Func code	Function name	Type	Access	Setting Items	Data resolution· units
1066	0xEE	PA-01	Mode selection for Emergency-force drive	UINT	RW	0 ~ 1	1
1066	0xEF	PA-02	Frequency reference setting at Emergency-force drive	UINT	RW	0 ~ 59000	0.01Hz
1066	0xF0	PA-03	Direction command at Emergency-force drive	UINT	RW	0 ~ 1	1
1066	0xF1	PA-04	Commercial power supply bypass function selection	UINT	RW	0 ~ 1	1
1066	0xF2	PA-05	Delay time of Bypass function	UINT	RW	0 ~ 10000	0.1s
1067	0x3	PA-20	Simulation mode enable	UINT	RW	0 ~ 1	1
1067	0x4	PA-21	Error code selection for Alarm test	UINT	RW	0 ~ 255	1
1067	0x5	PA-22	Output current monitor optional output enable	UINT	RW	0 ~ 7	1
1067	0x6	PA-23	Output current monitor optional output value setting	UINT	RW	(0~3.00)*CTL Rated current	0.1A
1067	0x7	PA-24	DC-bus voltage monitor optional output enable	UINT	RW	0 ~ 7	1
1067	0x8	PA-25	DC-bus voltage monitor optional value output	UINT	RW	200V class: 0 ~ 4500 400V class: 0 ~ 9000	0.1Vdc
1067	0x9	PA-26	Output voltage monitor optional output enable	UINT	RW	0 ~ 7	1
1067	0xA	PA-27	Output voltage monitor optional output value setting	UINT	RW	200V class: 0 ~ 3000 400V class: 0 ~ 6000	0.1V
1067	0xB	PA-28	Output torque monitor optional output enable	UINT	RW	0 ~ 7	1
1067	0xC	PA-29	Output torque monitor optional output value setting	UINT	RW	-5000 ~ 5000	0.1%

Index	Sub-index	Func code	Function name	Type	Access	Setting Items	Data resolution· units
1067	0xD	PA-30	Start with frequency matching optional Setting enable	UINT	RW	0 ~ 7	1
1067	0xE	PA-31	Start with frequency matching optional value setting	UINT	RW	0 ~ 59000	0.01Hz

### 13.2.9 Code-U

Index	Sub-index	Func code	Function name	Type	Access	Setting Items	Data resolution· units
1070	0xDE	UA-01	Password for Display	UINT	RW	0 ~ 65535	1
1070	0xDF	UA-02	Password for SoftLock	UINT	RW	0 ~ 65535	1
1070	0xE7	UA-10	Display restriction selection	UINT	RW	0 ~ 4	1
1070	0xE9	UA-12	Accumulation input power monitor clear	UINT	RW	0 ~ 1	1
1070	0xEA	UA-13	Display gain for Accumulation input power monitor	UINT	RW	1 ~ 1000	1
1070	0xEB	UA-14	Accumulation output power monitor clear	UINT	RW	0 ~ 1	1
1070	0xEC	UA-15	Display gain for Accumulation output power monitor	UINT	RW	1 ~ 1000	1
1070	0xED	UA-16	Soft Lock selection	UINT	RW	0 ~ 1	1
1070	0xEE	UA-17	Soft Lock target selection	UINT	RW	0 ~ 1	1
1070	0xEF	UA-18	Data R/W selection	UINT	RW	0 ~ 1	1
1070	0xF0	UA-19	Low battery warning enable	UINT	RW	0 ~ 2	1
1070	0xF1	UA-20	Action selection at keypad disconnection	UINT	RW	0 ~ 4	1
1070	0xF2	UA-21	2nd-motor parameter display selection	UINT	RW	0 ~ 1	1

Index	Sub-index	Func code	Function name	Type	Access	Setting Items	Data resolution· units
1070	0xF3	UA-22	Option parameter display selection at Full display	UINT	RW	0 ~ 1	1
1070	0xFB	UA-30	User parameter auto setting function enable	UINT	RW	0 ~ 1	1
1070	0xFC	UA-31	User parameter 1 selection	UINT	RW	0 ~ 65535 (register number)	1
1070	0xFD	UA-32	User parameter 2 selection	UINT	RW	0 ~ 65535 (register number)	1
1070	0xFE	UA-33	User parameter 3 selection	UINT	RW	0 ~ 65535 (register number)	1
1071	0x1	UA-34	User parameter 4 selection	UINT	RW	0 ~ 65535 (register number)	1
1071	0x2	UA-35	User parameter 5 selection	UINT	RW	0 ~ 65535 (register number)	1
1071	0x3	UA-36	User parameter 6 selection	UINT	RW	0 ~ 65535 (register number)	1
1071	0x4	UA-37	User parameter 7 selection	UINT	RW	0 ~ 65535 (register number)	1
1071	0x5	UA-38	User parameter 8 selection	UINT	RW	0 ~ 65535 (register number)	1
1071	0x6	UA-39	User parameter 9 selection	UINT	RW	0 ~ 65535 (register number)	1
1071	0x7	UA-40	User parameter 10 selection	UINT	RW	0 ~ 65535 (register number)	1
1071	0x8	UA-41	User parameter 11 selection	UINT	RW	0 ~ 65535 (register number)	1
1071	0x9	UA-42	User parameter 12 selection	UINT	RW	0 ~ 65535 (register number)	1
1071	0xA	UA-43	User parameter 13 selection	UINT	RW	0 ~ 65535 (register number)	1
1071	0xB	UA-44	User parameter 14 selection	UINT	RW	0 ~ 65535 (register number)	1
1071	0xC	UA-45	User parameter 15 selection	UINT	RW	0 ~ 65535 (register number)	1
1071	0xD	UA-46	User parameter 16 selection	UINT	RW	0 ~ 65535 (register number)	1
1071	0xE	UA-47	User parameter 17 selection	UINT	RW	0 ~ 65535 (register number)	1
1071	0xF	UA-48	User parameter 18 selection	UINT	RW	0 ~ 65535 (register number)	1
1071	0x10	UA-49	User parameter 19 selection	UINT	RW	0 ~ 65535 (register number)	1
1071	0x11	UA-50	User parameter 20 selection	UINT	RW	0 ~ 65535 (register number)	1
1071	0x12	UA-51	User parameter 21 selection	UINT	RW	0 ~ 65535 (register number)	1
1071	0x13	UA-52	User parameter 22 selection	UINT	RW	0 ~ 65535 (register number)	1
1071	0x14	UA-53	User parameter 23 selection	UINT	RW	0 ~ 65535 (register number)	1

Index	Sub-index	Func code	Function name	Type	Access	Setting Items	Data resolution· units
1071	0x15	UA-54	User parameter 24 selection	UINT	RW	0 ~ 65535 (register number)	1
1071	0x16	UA-55	User parameter 25 selection	UINT	RW	0 ~ 65535 (register number)	1
1071	0x17	UA-56	User parameter 26 selection	UINT	RW	0 ~ 65535 (register number)	1
1071	0x18	UA-57	User parameter 27 selection	UINT	RW	0 ~ 65535 (register number)	1
1071	0x19	UA-58	User parameter 28 selection	UINT	RW	0 ~ 65535 (register number)	1
1071	0x1A	UA-59	User parameter 29 selection	UINT	RW	0 ~ 65535 (register number)	1
1071	0x1B	UA-60	User parameter 30 selection	UINT	RW	0 ~ 65535 (register number)	1
1071	0x1C	UA-61	User parameter 31 selection	UINT	RW	0 ~ 65535 (register number)	1
1071	0x1D	UA-62	User parameter 32 selection	UINT	RW	0 ~ 65535 (register number)	1
1071	0x39	UA-90	Keypad indication off waiting time	UINT	RW	0 ~ 60	1min
1071	0x3A	UA-91	Initial Disply selection	UINT	RW	0 ~ 65535 (d,Fcode register number)	1
1071	0x3B	UA-92	Auto-return to Initial display enable	UINT	RW	0 ~ 1	1
1071	0x3C	UA-93	Setting enable at Monitor display	UINT	RW	0 ~ 1	1
1071	0x3D	UA-94	Multispeed change on the frequency reference monitor display	UINT	RW	0 ~ 1	1
1071	0x44	Ub-01	Initialize Mode selection	UINT	RW	0 ~ 8	1
1071	0x45	Ub-02	Initialize Data sel	UINT	RW	0 ~ 3	1
1071	0x46	Ub-03	Load type selection	UINT	RW	0 ~ 2	1
1071	0x48	Ub-05	Initialize Enable	UINT	RW	0 ~ 1	1
1071	0xA8	UC-01	Debug mode enable	UINT	RW	0 ~ 3	1
1072	0xE	Ud-01	Trace function enable	UINT	RW	0 ~ 1	1
1072	0xF	Ud-02	Trace start	UINT	RW	0 ~ 1	1
1072	0x10	Ud-03	Trace data number setting	UINT	RW	0 ~ 8	1
1072	0x11	Ud-04	Trace signal number setting	UINT	RW	0 ~ 8	1
1072	0x17	Ud-10	Trace data 0 selection	UINT	RW	0 ~ 65535 (d,Fcode register number)	1
1072	0x18	Ud-11	Trace data 1 selection	UINT	RW	0 ~ 65535 (d,Fcode register number)	1
1072	0x19	Ud-12	Trace data 2 selection	UINT	RW	0 ~ 65535 (d,Fcode register number)	1

Index	Sub-index	Func code	Function name	Type	Access	Setting Items	Data resolution· units
1072	0x1A	Ud-13	Trace data 3 selection	UINT	RW	0 ~ 65535 (d,Fcode register number)	1
1072	0x1B	Ud-14	Trace data 4 selection	UINT	RW	0 ~ 65535 (d,Fcode register number)	1
1072	0x1C	Ud-15	Trace data 5 selection	UINT	RW	0 ~ 65535 (d,Fcode register number)	1
1072	0x1D	Ud-16	Trace data 6 selection	UINT	RW	0 ~ 65535 (d,Fcode register number)	1
1072	0x1E	Ud-17	Trace data 7 selection	UINT	RW	0 ~ 65535 (d,Fcode register number)	1
1072	0x21	Ud-20	Trace signal 0 Input/Output selection	UINT	RW	0 ~ 1	1
1072	0x22	Ud-21	Trace signal 0 Input Terminal selection	UINT	RW	0 ~ 110	1
1072	0x23	Ud-22	Trace signal 0 Output Terminal selection	UINT	RW	0 ~ 93	1
1072	0x24	Ud-23	Trace signal 1 Input/Output selection	UINT	RW	0 ~ 1	1
1072	0x25	Ud-24	Trace signal 1 Input Terminal selection	UINT	RW	0 ~ 110	1
1072	0x26	Ud-25	Trace signal 1 Output Terminal selection	UINT	RW	0 ~ 93	1
1072	0x27	Ud-26	Trace signal 2 Input/Output selection	UINT	RW	0 ~ 1	1
1072	0x28	Ud-27	Trace signal 2 Input Terminal selection	UINT	RW	0 ~ 110	1
1072	0x29	Ud-28	Trace signal 2 Output Terminal selection	UINT	RW	0 ~ 93	1
1072	0x2A	Ud-29	Trace signal 3 Input/Output selection	UINT	RW	0 ~ 1	1
1072	0x2B	Ud-30	Trace signal 3 Input Terminal selection	UINT	RW	0 ~ 110	1
1072	0x2C	Ud-31	Trace signal 3 Output Terminal selection	UINT	RW	0 ~ 93	1
1072	0x2D	Ud-32	Trace signal 4 Input/Output selection	UINT	RW	0 ~ 1	1
1072	0x2E	Ud-33	Trace signal 4 Input Terminal selection	UINT	RW	0 ~ 110	1
1072	0x2F	Ud-34	Trace signal 4 Output Terminal selection	UINT	RW	0 ~ 93	1

Index	Sub-index	Func code	Function name	Type	Access	Setting Items	Data resolution·units
1072	0x30	Ud-35	Trace signal 5 Input/Output selection	UINT	RW	0 ~ 1	1
1072	0x31	Ud-36	Trace signal 5 Input Terminal selection	UINT	RW	0 ~ 110	1
1072	0x32	Ud-37	Trace signal 5 Output Terminal selection	UINT	RW	0 ~ 93	1
1072	0x33	Ud-38	Trace signal 6 Input/Output selection	UINT	RW	0 ~ 1	1
1072	0x34	Ud-39	Trace signal 6 Input Terminal selection	UINT	RW	0 ~ 110	1
1072	0x35	Ud-40	Trace signal 6 Output Terminal selection	UINT	RW	0 ~ 93	1
1072	0x36	Ud-41	Trace signal 7 Input/Output selection	UINT	RW	0 ~ 1	1
1072	0x37	Ud-42	Trace signal 7 Input Terminal selection	UINT	RW	0 ~ 110	1
1072	0x38	Ud-43	Trace signal 7 Output Terminal selection	UINT	RW	0 ~ 93	1
1072	0x3F	Ud-50	Trace trigger 1 selection	UINT	RW	0 ~ 16	1
1072	0x40	Ud-51	Trigger 1 action selection at trace data trigger	UINT	RW	0 ~ 1	1
1072	0x41	Ud-52	Trigger 1 level setting at trace data trigger	UINT	RW	0 ~ 100	1%
1072	0x42	Ud-53	Trigger 1 action selection at trace signal trigger	UINT	RW	0 ~ 1	1
1072	0x43	Ud-54	Trace trigger 2 selection	UINT	RW	0 ~ 16	1
1072	0x44	Ud-55	Trigger 2 action selection at trace data trigger	UINT	RW	0 ~ 1	1
1072	0x45	Ud-56	Trigger 2 level setting at trace data trigger	UINT	RW	0 ~ 100	1%
1072	0x46	Ud-57	Trigger 2 action selection at trace signal trigger	UINT	RW	0 ~ 1	1
1072	0x47	Ud-58	Trigger condition selection	UINT	RW	0 ~ 3	1
1072	0x48	Ud-59	Trigger point setting	UINT	RW	0 ~ 100	1%
1072	0x49	Ud-60	Sampling time selection	UINT	RW	1 ~ 10	1

Index	Sub-index	Func code	Function name	Type	Access	Setting Items	Data resolution· units
1072	0x72	UE-01	EzSQ operation cycle	UINT	RW	0 ~ 1	1
1072	0x73	UE-02	EzSQ function enable	UINT	RW	0 ~ 2	1
1072	0x7B	UE-10	EzSQ User parameter U(00)	UINT	RW	0 ~ 65535	1
1072	0x7C	UE-11	EzSQ User parameter U(01)	UINT	RW	0 ~ 65535	1
1072	0x7D	UE-12	EzSQ User parameter U(02)	UINT	RW	0 ~ 65535	1
1072	0x7E	UE-13	EzSQ User parameter U(03)	UINT	RW	0 ~ 65535	1
1072	0x7F	UE-14	EzSQ User parameter U(04)	UINT	RW	0 ~ 65535	1
1072	0x80	UE-15	EzSQ User parameter U(05)	UINT	RW	0 ~ 65535	1
1072	0x81	UE-16	EzSQ User parameter U(06)	UINT	RW	0 ~ 65535	1
1072	0x82	UE-17	EzSQ User parameter U(07)	UINT	RW	0 ~ 65535	1
1072	0x83	UE-18	EzSQ User parameter U(08)	UINT	RW	0 ~ 65535	1
1072	0x84	UE-19	EzSQ User parameter U(09)	UINT	RW	0 ~ 65535	1
1072	0x85	UE-20	EzSQ User parameter U(10)	UINT	RW	0 ~ 65535	1
1072	0x86	UE-21	EzSQ User parameter U(11)	UINT	RW	0 ~ 65535	1
1072	0x87	UE-22	EzSQ User parameter U(12)	UINT	RW	0 ~ 65535	1
1072	0x88	UE-23	EzSQ User parameter U(13)	UINT	RW	0 ~ 65535	1
1072	0x89	UE-24	EzSQ User parameter U(14)	UINT	RW	0 ~ 65535	1
1072	0x8A	UE-25	EzSQ User parameter U(15)	UINT	RW	0 ~ 65535	1
1072	0x8B	UE-26	EzSQ User parameter U(16)	UINT	RW	0 ~ 65535	1
1072	0x8C	UE-27	EzSQ User parameter U(17)	UINT	RW	0 ~ 65535	1
1072	0x8D	UE-28	EzSQ User parameter U(18)	UINT	RW	0 ~ 65535	1
1072	0x8E	UE-29	EzSQ User parameter U(19)	UINT	RW	0 ~ 65535	1
1072	0x8F	UE-30	EzSQ User parameter U(20)	UINT	RW	0 ~ 65535	1
1072	0x90	UE-31	EzSQ User parameter U(21)	UINT	RW	0 ~ 65535	1
1072	0x91	UE-32	EzSQ User parameter U(22)	UINT	RW	0 ~ 65535	1
1072	0x92	UE-33	EzSQ User parameter U(23)	UINT	RW	0 ~ 65535	1
1072	0x93	UE-34	EzSQ User parameter U(24)	UINT	RW	0 ~ 65535	1



Index	Sub-index	Func code	Function name	Type	Access	Setting Items	Data resolution· units
1072	0x94	UE-35	EzSQ User parameter U(25)	UINT	RW	0 ~ 65535	1
1072	0x95	UE-36	EzSQ User parameter U(26)	UINT	RW	0 ~ 65535	1
1072	0x96	UE-37	EzSQ User parameter U(27)	UINT	RW	0 ~ 65535	1
1072	0x97	UE-38	EzSQ User parameter U(28)	UINT	RW	0 ~ 65535	1
1072	0x98	UE-39	EzSQ User parameter U(29)	UINT	RW	0 ~ 65535	1
1072	0x99	UE-40	EzSQ User parameter U(30)	UINT	RW	0 ~ 65535	1
1072	0x9A	UE-41	EzSQ User parameter U(31)	UINT	RW	0 ~ 65535	1
1072	0x9B	UE-42	EzSQ User parameter U(32)	UINT	RW	0 ~ 65535	1
1072	0x9C	UE-43	EzSQ User parameter U(33)	UINT	RW	0 ~ 65535	1
1072	0x9D	UE-44	EzSQ User parameter U(34)	UINT	RW	0 ~ 65535	1
1072	0x9E	UE-45	EzSQ User parameter U(35)	UINT	RW	0 ~ 65535	1
1072	0x9F	UE-46	EzSQ User parameter U(36)	UINT	RW	0 ~ 65535	1
1072	0xA0	UE-47	EzSQ User parameter U(37)	UINT	RW	0 ~ 65535	1
1072	0xA1	UE-48	EzSQ User parameter U(38)	UINT	RW	0 ~ 65535	1
1072	0xA2	UE-49	EzSQ User parameter U(39)	UINT	RW	0 ~ 65535	1
1072	0xA3	UE-50	EzSQ User parameter U(40)	UINT	RW	0 ~ 65535	1
1072	0xA4	UE-51	EzSQ User parameter U(41)	UINT	RW	0 ~ 65535	1
1072	0xA5	UE-52	EzSQ User parameter U(42)	UINT	RW	0 ~ 65535	1
1072	0xA6	UE-53	EzSQ User parameter U(43)	UINT	RW	0 ~ 65535	1
1072	0xA7	UE-54	EzSQ User parameter U(44)	UINT	RW	0 ~ 65535	1
1072	0xA8	UE-55	EzSQ User parameter U(45)	UINT	RW	0 ~ 65535	1
1072	0xA9	UE-56	EzSQ User parameter U(46)	UINT	RW	0 ~ 65535	1
1072	0xAA	UE-57	EzSQ User parameter U(47)	UINT	RW	0 ~ 65535	1
1072	0xAB	UE-58	EzSQ User parameter U(48)	UINT	RW	0 ~ 65535	1
1072	0xAC	UE-59	EzSQ User parameter U(49)	UINT	RW	0 ~ 65535	1
1072	0xAD	UE-60	EzSQ User parameter U(50)	UINT	RW	0 ~ 65535	1
1072	0xAE	UE-61	EzSQ User parameter U(51)	UINT	RW	0 ~ 65535	1

Index	Sub-index	Func code	Function name	Type	Access	Setting Items	Data resolution·units
1072	0xAF	UE-62	EzSQ User parameter U(52)	UINT	RW	0 ~ 65535	1
1072	0xB0	UE-63	EzSQ User parameter U(53)	UINT	RW	0 ~ 65535	1
1072	0xB1	UE-64	EzSQ User parameter U(54)	UINT	RW	0 ~ 65535	1
1072	0xB2	UE-65	EzSQ User parameter U(55)	UINT	RW	0 ~ 65535	1
1072	0xB3	UE-66	EzSQ User parameter U(56)	UINT	RW	0 ~ 65535	1
1072	0xB4	UE-67	EzSQ User parameter U(57)	UINT	RW	0 ~ 65535	1
1072	0xB5	UE-68	EzSQ User parameter U(58)	UINT	RW	0 ~ 65535	1
1072	0xB6	UE-69	EzSQ User parameter U(59)	UINT	RW	0 ~ 65535	1
1072	0xB7	UE-70	EzSQ User parameter U(60)	UINT	RW	0 ~ 65535	1
1072	0xB8	UE-71	EzSQ User parameter U(61)	UINT	RW	0 ~ 65535	1
1072	0xB9	UE-72	EzSQ User parameter U(62)	UINT	RW	0 ~ 65535	1
1072	0xBA	UE-73	EzSQ User parameter U(63)	UINT	RW	0 ~ 65535	1
2072	0xD7	UF-02	EzSQ User parameter UL(00)	UDINT	RW	-2147483647 ~ 2147483647	1
2072	0xD9	UF-04	EzSQ User parameter UL(01)	UDINT	RW	-2147483647 ~ 2147483647	1
2072	0xDB	UF-06	EzSQ User parameter UL(02)	UDINT	RW	-2147483647 ~ 2147483647	1
2072	0xDD	UF-08	EzSQ User parameter UL(03)	UDINT	RW	-2147483647 ~ 2147483647	1
2072	0xDF	UF-10	EzSQ User parameter UL(04)	UDINT	RW	-2147483647 ~ 2147483647	1
2072	0xE1	UF-12	EzSQ User parameter UL(05)	UDINT	RW	-2147483647 ~ 2147483647	1
2072	0xE3	UF-14	EzSQ User parameter UL(06)	UDINT	RW	-2147483647 ~ 2147483647	1
2072	0xE5	UF-16	EzSQ User parameter UL(07)	UDINT	RW	-2147483647 ~ 2147483647	1
2072	0xE7	UF-18	EzSQ User parameter UL(08)	UDINT	RW	-2147483647 ~ 2147483647	1
2072	0xE9	UF-20	EzSQ User parameter UL(09)	UDINT	RW	-2147483647 ~ 2147483647	1

Index	Sub-index	Func code	Function name	Type	Access	Setting Items	Data resolution· units
2072	0xEB	UF-22	EzSQ User parameter UL(10)	UDINT	RW	-2147483647 ~ 2147483647	1
2072	0xED	UF-24	EzSQ User parameter UL(11)	UDINT	RW	-2147483647 ~ 2147483647	1
2072	0xEF	UF-26	EzSQ User parameter UL(12)	UDINT	RW	-2147483647 ~ 2147483647	1
2072	0xF1	UF-28	EzSQ User parameter UL(13)	UDINT	RW	-2147483647 ~ 2147483647	1
2072	0xF3	UF-30	EzSQ User parameter UL(14)	UDINT	RW	-2147483647 ~ 2147483647	1
2072	0xF5	UF-32	EzSQ User parameter UL(15)	UDINT	RW	-2147483647 ~ 2147483647	1

## 13.2.10 Others

Index	Sub-index	Func code	Function name	Type	Access	Setting Items	Data resolution·units
1035	0x6F	-	EEPROM Write	UINT	W	01 : Write all parameters	1
1035	0x71	-	EEPROM Write Mode Selection	UINT	W	01 : enabled	1
1035	0x79	-	Motor Constant Recomputation	UINT	W	01 : enabled	1
1063	0x34	-	Output terminal function option output (OPO output)	UINT	RW	0 ~ 0x7F	1
1063	0x3B	-	Coil data 0 (coil No. 0001h - 000Fh)	UINT	RW	0 ~ 0xFFFF	1
1063	0x3C	-	Coil data 1 (coil No. 0010h - 001Fh)	UINT	RW	0 ~ 0xFFFF	1
1063	0x3D	-	Coil data 2 (coil No. 0020h - 002Fh)	UINT	RW	0 ~ 0xFFFF	1
1063	0x3E	-	Coil data 3 (coil No. 0030h - 003Fh)	UINT	RW	0 ~ 0xFFFF	1
1063	0x3F	-	Coil data 4 (coil No. 0040h - 004Fh)	UINT	RW	0 ~ 0xFFFF	1

(Memo)

---

# Appendix 1 Revision History

---



**Appendix**

## Contents

A1.1 About this chapter.....	A1-1
A1.2 Revision History .....	A1-2

### A1.1 About this chapter

The revision history is provided in this chapter.

A1.2 Revision History

\* Typographical errors may be corrected without prior notice.

**Revision History**

<b>No.</b>	<b>Revision details</b>	<b>Date</b>
NT257X	Initial edition	2018/02