

After reading this guide, keep it handy for future reference.



User's Guide

Hitachi Inverter

Communication Option for the EtherCAT

P1-ECT

Fundamental	S	Introduction · Cautions
	C	Table of Contents
	1	Safety Precautions
	2	Overview
	3	Preparing for Operation
	4	About the P1-ECT
Required	5	Enclosed Items
	6	Installing and Connecting
	7	Inverter Settings
	8	About EtherCAT
Verification	9	About the CiA402
	10	Object Dictionary
	11	FAQ and Troubleshooting
	12	Specifications
	13	Parameter List

S.1 Introduction

Thank you for purchasing the P1-ECT: communication option for Hitachi SJ series P1 (afterward, "Hitachi SJ series P1" referred as SJ-P1).

This user's guide describes how to handle and maintain the P1-ECT. Please read this guide carefully before using the P1-ECT, and keep it handy for those who operate, maintain and inspect it.

For the purpose of reducing paper consumption and provision of the latest information, we enclose the Basic Guide only, while providing the User's Guide for more detailed description through electronic data instead of CD or printed document.

■ About the User's Guide (this document)

The User's Guide provides detailed information necessary for handling the product. Please make sure to read this Guide for proper use.

If future updated descriptions differ from the Basic Guide, the description in the User's Guide will have higher priority. Always use the P1-ECT strictly within the range described in the User's Guide and perform proper inspection and maintenance to prevent failures or accidents.

The latest version of the User's guide can be obtained through our website. In case it is not available or cannot be downloaded please contact the nearest sales office.

■ About the Basic Guide

The Basic Guide provides the minimum information necessary for handling the product. Please make sure to read the Basic Guide as well as the User's Guide for more detailed information.

■ Handling the inverter

For handling the inverter, please make sure to read its Basic Guide and User's Guide.

S.2 Cautions

■ For a proper use

Before using the inverter, please read carefully the inverter's Basic and User's Guide, the P1-ECT Basic Guide and this guide.

In Addition any personnel who handles or performs maintenance to the product must read carefully the inverter's Basic and User's Guide, the P1-ECT Basic Guide and this guide.

Before any attempt to install, operate, maintain or inspect this equipment, a complete understanding of the equipment specifications, safety instructions, precautions, handling and operation instructions is required. Additionally, periodically review the inverter's Basic and User's Guide, the P1-ECT User's Guide and this guide.

■ Precautions

It is prohibited to reproduce or reform this document partially or totally in any form without the publisher's permission.

The contents of the document are subject to change without prior notice.

If a hard copy of this document is required please contact the nearest sales office. Keep in mind that you will be charged for a hard copy of this document.

Any handling, maintenance or operation method NOT described on the inverter's Basic and User's Guide, the P1-ECT Basic Guide or this guide is not covered by the product warranty. Please DO NOT perform any procedure NOT described on the SJ-P1 or the P1-ECT guides since it can be the cause of unexpected failures or accidents.

We are not responsible for any impact from operations regardless of unexpected failure or accident due to operation or handling of the product in a manner not specified on the inverter's Basic and User's Guide, the P1-ECT Basic Guide or this guide. We appreciate your understanding.

If you find any unclear or incorrect description, missing description or misplaced or missing pages, Please inform the Hitachi inverter technical service office.

Note that, in case the inverter's Basic and User's Guide, the P1-ECT Basic Guide or this guide are enclosed, they should be delivered to the end user of the inverter. Also make sure to download and keep accessible any other related guides or instructions for the end user.

S.3 Product Warranty and Inquiry

■ About product inquiry

- For an inquiry about product damage or faults or a question about the product, notify your supplier or Hitachi inverter technical service office.

When contacting the technical service, please provide the following information.

- Model: P1-ECT
- Manufacture Number (MFG No.) :It shows on the name plate.
(Please refer to the chapter 4, for more information)
- Date of Purchase: Purchase date by the customer
- Inquiry contents
 - Inform us the defective point and its condition.
 - Inform us the suspicious content and its details.

■ Product warranty

- The product P1-ECT will be warranted by Hitachi Industrial Equipment Systems Co., Ltd. (afterwards referred as “Hitachi”) during the warranty period from your date of purchase only under proper usage of product.
- However, the warranty expressed here is covered only for products delivered from Hitachi, and will not be responsible for others damage or loss of products like a motor or any equipment or systems damage caused by improper usage of the product. We recommend applying safety design which is able to provide a hazard notice to the user in case of malfunction or damage of the delivered product to minimize the consequences on other equipment or system. We advise that the selection of the delivered product is done with sufficient margin for performance, as well as using redundant design for other equipment or systems. Also, the compatibility of the product with the customer’s intended use is not warranted, hence the customer has the responsibility to perform validation tests before any operation.
- In case a defective product is delivered, or quality failure during the manufacturing process are detected,, Hitachi will repair or exchange the product free of charge, only during the product warranty period (afterward, referred as “warranty service”).
- The product will be warranted for one year from the date of purchase. However, depending on the case, actual expenses for sending technical assistance will be charged to the customer. Also, Hitachi will not be responsible of any readjustment or testing on site.
- After a warranty service, the exchanged or repaired part will be warranted for 6 months from the date of the warranty service. Hitachi will be responsible for repairing or exchanging the previously exchanged or repaired part only during this warranty period.

- Please verify that the inverter settings are adequate for operation, before operating it remotely through the network.
- In order to receive warranty service, you should present the receipt issued by the product supplier or any other document that allow us to check the purchase date. However, any defects, damage, malfunction or any other failure caused by one of the following facts will not be covered by warranty service.

- (1) Cannot confirm the purchase date.
- (2) The damage or fault resulted from improper usage or inadequate handling of the product or usage that does not comply with the instructions described in the user’s guide or basic guide.
- (3) Incorrect usage of the product and/or the inverter, inadequate setting of the product and/or the inverter, remodeling or inadequate repair or repair carried out by an unqualified repair center.
- (4) Deterioration and wear as result of normal operation.
- (5) Fault resulted from natural disaster, such as earthquake, fire disaster, lightning strike, pollution, salt pollution, or abnormal voltage or any others external factors.
- (6) Shock, falling, or Vibration resulted during transportation or displacement after purchase.
- (7) Damage or fault resulted from remodeling firmware by unqualified personal not belonging to Hitachi.
- (8) Damage or fault resulted from using a function program (EzSQ).
- (9) For overseas use.

■ Liability limitation

- In this product warranty, all warranties offered to the customer are stipulated, and neither Hitachi, affiliated companies or related dealers are liable to any express warranties or implied warranties including, but not limited to, product merchantability or specific application fitness.
- Also, Hitachi, affiliated companies or related dealers are not responsible of any incidental damage, special damage, direct loss, or indirect loss (even predictable or not) sustained by the customer as a result of a faulty product.

■ Using the warranty service

- The customer is able to receive a warranty service during the warranty period from the product supplier or service station, if the product does not meet the specifications described in this guide or the basic guide. However, this guide will have priority in case of content mismatch between this and the basic guide.
- A fare-paying service can also be obtained by contacting your supplier, local Hitachi distributor or service station.

■ Change on product specifications

- Please be aware that the information described in Brochure, Basic Guide, User's Guide or Technical Document might be modified without notice.

■ Precautions for the product operation

- The product should be operated following the working conditions, handling methods and precautions described in User's Guide.
- Please verify that the inverter settings are adequate for operation, before operating it remotely through the network.
- Please verify that the Hitachi inverter is correctly configured and installed for the intended purpose in the designed system.
- When using the Hitachi inverter please implement the following actions.
 - (1) Select an inverter with sufficient capacity for the rated current and performance.
 - (2) Implement safety design such as redundant system design.
 - (3) Implement safety design which minimizes risks in case of an inverter failure.
 - (4) Design the system in a way it can warn the operator about any danger.
 - (5) Carry out periodic maintenance to the customer's equipment as well as the inverter.
- For applications that involve human life, or have risk of an important loss, make sure to avoid a critical accident by installing a fail-safe device, protecting device, detecting device, alarm device, and/or spare device, etc.

■ Operation warranty

- Even though the P1-ECT complies with the EtherCAT standard, we do not guarantee that it will operate properly with all types of master devices.

■ Supplement

- This warranty term will not restrict the legal right of customer who has purchased the product.
- This warranty is valid only in Japan(excluding special types of contracts).
- Contact your sales agent for warranty of products purchased overseas.

S.4 Getting Started

- Please follow the steps written below for start using the P1-ECT.
- Before operating the device, please read and fully understand the safety precautions written below and on the Chapter 1.

Procedure▶	Verification Points▶	For more information
1. Safety Confirmation	• Verify all safety precautions needed for handling the P1-ECT.	• Please refer to the Chapter 1 “Safety Precautions and risks”
2. Verification of bundled products	• Verify that the included items with the P1-ECT do not have any defects.	• Please refer to the Chapter 5 “Enclosed Items”
3. Preparation for Operation	• Verify every step and procedure needed for a P1-ECT trial run.	• Please refer to the Chapter 3 “Preparing for Operation”

For more information, please refer to the following.

About EtherCAT ⇒ Chapter 8
EtherCAT will be explained.

About CiA402 ⇒ Chapter 9
CiA402 will be explained.

Object Dictionary ⇒ Chapter 10
The object dictionary will be explained.

FAQ and Troubleshooting ⇒ Chapter 11
Problems that may occur with the P1-ECT and the inverter will be explained.

In case the problem cannot be solved
Contact your supplier or the Hitachi technical service.

S. 5 Related Documents

Document Name (Cassette Option)	Document Code
P1-ECT (EtherCAT Slave) User's Guide (this guide)	NT255X
P1-ECT (EtherCAT Slave) Basic Guide	NT2551X

Document Name (Inverter)	Document Code
SJ series P1 User's Guide	NT251*
SJ series P1 Basic Guide	NT2511*

The (*) symbol on the Document Code column represents the version of the inverter guide.

S. 6 Registered Trademark

EtherCAT® is registered trademark and patented technology, licensed by Beckhoff Automation GmbH, Germany.

C.1 Table of Contents

- Introduction • Cautions..... S-1
- Product Warranty and Inquiry..... S-2
- Table of Contents..... C-1

Chapter 1 Safety Precautions

- | | |
|---------------------------------|-------------------------------------|
| 1.1 About this chapter..... 1-1 | 1.5 Caution label examples..... 1-7 |
| 1.2 Types of warnings..... 1-1 | |
| 1.3 Symbol explanation..... 1-2 | |
| 1.4 Precautions 1-3 | |

Chapter 2 Overview

- | | |
|--|--------------------------------|
| 2.1 About this chapter..... 2-1 | 2.6 Terminology..... 2-3 |
| 2.2 Applicable devices..... 2-1 | 2.7 Symbol definition..... 2-3 |
| 2.3 Before reading this guide..... 2-1 | |
| 2.4 Guide objectives..... 2-1 | |
| 2.5 Guide outline..... 2-2 | |

Chapter 3 Preparing for Operation

- | | |
|---------------------------------|--|
| 3.1 About this chapter..... 3-1 | |
| 3.2 Preparation steps..... 3-2 | |

Chapter 4 About the P1-ECT

- | | |
|---------------------------------|---|
| 4.1 About this chapter..... 4-1 | 4.4 Dimensions after installed..... 4-6 |
| 4.2 External features..... 4-2 | |
| 4.3 Name plate 4-6 | |

Chapter 5 Enclosed Items

- | | |
|---------------------------------------|--|
| 5.1 About this chapter..... 5-1 | 5.3 Verification after the purchase..... 5-3 |
| 5.2 About the enclosed items..... 5-2 | |

Chapter 6 Installing and Connecting

- | | |
|----------------------------------|---------------------------------------|
| 6.1 About this chapter..... 6-1 | 6.4 Attach the ferrite cores..... 6-4 |
| 6.2 Supported inverters..... 6-2 | 6.5 About the connection..... 6-5 |
| 6.3 Installation..... 6-2 | |

Chapter 7 Inverter Setting

- | | |
|---------------------------------|---------------------------------|
| 7.1 About this chapter..... 7-1 | 7.2 Parameter settings..... 7-2 |
|---------------------------------|---------------------------------|

Chapter 8 About EtherCAT

8.1 About this chapter.....	8-1	8.5 PDO communication.....	8-4
8.2 ESI File	8-2	8.6 SDO communication.....	8-4
8.3 CANopen over EtherCAT.....	8-2	8.7 Emergency messages.....	8-5
8.4 EtherCAT state transition.....	8-3		

Chapter 9 About CiA402

9.1 About this chapter.....	9-1	9.5 Operation mode.....	9-4
9.2 CiA402 state transition.....	9-2	9.6 Velocity mode.....	9-5
9.3 0x6040 Controlword.....	9-3	9.7 Application Example.....	9-7
9.4 0x6041 Statusword.....	9-4		

Chapter 10 About the Object Dictionary

10.1 About this chapter.....	10-1	10.4 Manufacturer specific area (Inverter parameter area).....	10-20
10.2 Object Dictionary.....	10-2	10.5 Device profile area.....	10-22
10.3 CoE communication area.....	10-4		

Chapter 11 FAQ and Troubleshooting

11.1 About this chapter.....	11-1	11.3 P1-ECT troubleshooting.....	11-3
11.2 Self-diagnosis.....	11-2	11.4 Inverter troubleshooting.....	11-6

Chapter 12 Specifications

12.1 About this chapter.....	12-1	12.2 Device specifications.....	12-2
------------------------------	------	---------------------------------	------

Chapter 13 Parameter List

13.1 About this chapter.....	13-1	13.2 Parameter list.....	13-2
------------------------------	------	--------------------------	------

(Memo)

1

Chapter 1 Safety Precautions

Contents

1.1 About this chapter.....	1-1
1.2 Types of warnings.....	1-1
1.3 Symbol explanation.....	1-2
1.4 Precautions	1-3
1.4.1 Please be Careful!	1-3
1.4.2 Precautions during the installation!	1-3
1.4.3 Precautions during the wiring!...	1-4
1.4.4 Precautions during operation!	1-5
1.4.5 Precautions during Maintenance/ Inspection!	1-5
1.4.6 Precautions for disposal !	1-6
1.4.7 Other Precautions	1-6
1.5 Caution labels examples.....	1-7

1.1 About this chapter

This chapter contains the information about Safety precautions during the installation, wiring, operation and inspection.

Before installation, wiring, operation, inspection, or usage please read completely and fully understand this guide.

1.2 Types of warnings

In this guide, the safety precautions as well as residual risks are categorized by degree of risk as “Danger”, “Warning” and “Caution” .

The definition of each category is described below.

Danger

This category warns the user that in case of an incorrect or improper handling, it leads to a dangerous situation that have a high risk of causing death, serious injuries and/or major property damage.

Warning

This category warns the user that in case of an incorrect or improper handling, it leads to a dangerous situation that may cause death, serious injuries and/or major property damage.

Caution

This category warns the user that in case of an incorrect or improper handling, it leads to a dangerous situation that may cause physical injuries and/or property damage.







However, any content labeled with “ **Caution**” and depending on the case, might have a possibility of leading to a highly dangerous situation. It is extremely important that you follow the instructions and warnings.

Furthermore, content labeled with “” must be followed and paid special attention .

1.3 Symbol explanation

In this guide, there are some explanatory notes using different symbols. Please pay attention to this content and keep in mind its information.

Symbol definition

	When handling this product, this symbol indicates danger, warning or caution about ignition, electric shock, high temperature or other dangers. Inside or near the  symbol, the specific content will be shown.	
		This symbol indicates “General hazard not specified, be cautious” .
		This symbol indicates “Electric shock hazard” .
	This symbol indicates prohibited actions “Actions that should not be done” when handling this device.	
	This symbol indicates actions that must be done based on the instructions.	

1.4 Precautions

1.4.1 Please be careful !



- If handled incorrectly or improperly, it might cause death, serious physical injuries, or damage to the inverter, motor or even the entire system.



- Before installation, wiring, operation, inspection, or usage please read and fully understand this guide and other references.



- In order to explain this device details the illustrations in this guide might show this device without covers.



- Before operating this device please return all the covers to the original position, and follow all the necessary regulations and instructions written in this guide.



- There will be additional warnings about hazards and failure causes in other chapters.



- Before installation, wiring, operation, inspection, or usage please read and fully understand this guide.

1.4.2 Precautions during the installation!



● Risk of Fire !



- DO NOT place inflammable objects nearby
- DO NOT let scraps of wire, welding sputtering, irons scraps or other objects get inside the device.



Prohibited



- Avoid installing this device in places with high temperature, high humidity, Condensation-prone conditions, dusty conditions, corrosive gas, explosive gas, flammable gas, grinding fluid mist, hydrogen sulfide or salt damage prone conditions. Additionally, it is recommended to install this device in ventilated room not exposed to direct sunlight.

● Risk of an Inverter failure !



- This device is a precision equipment, DO NOT drop it, or give it a strong shock.
- DO NOT get on (step on) or place heavy objects on this device.
- When handling the object, avoid places prone to static electricity (like carpets).



- Since the human body can get charged with static electricity, as a safety measure please touch a safe metallic surface before handling this device.



● Risk of Injury !

- DO NOT install or operate products with damage or missing parts.



Prohibited

1.4.3 Precautions during the wiring!

**Danger**Electric
shock
and Fire
hazard

● Risk of an electric shock and/or fire !

- Be sure to ground the inverter.
- Entrust the wiring work only to a qualified electrician.
- Before the wiring work make sure to turn off the power supply and wait for more than 10 or 15 minutes depending on the inverter model(*). (Confirm that the charge lamp is OFF and the DC voltage between terminals P and N is 45 V or less)



Do

Electric
shock and
injury

● Risk of an electric shock and/or injury !

- Perform the wiring only after installing the inverter.



Do



Failure

● Risk of inverter failure !

- DO NOT pull any wire after wiring.



Prohibited

*) For P1-00044-L to P1-01240-L (P1-004L to P1-220L), P1-00041-H to P1-00620-H (P1-007H to P1-220H) models the wait time is 10 minutes. For P1-01530-L to P1-02950-L (P1-300L to P1-550L), P1-00770-H to P1-03160-H (P1-300H to P1-1320H) models the wait time is 15 minutes.

**Warning**Electric
shock and
injury

● Risk of an electric shock and/or injury !

- DO NOT operate/switch any of the switches from the 4 pole DIP switch on this device. When this device is shipped all switches are turned off.
- If any of the switches from the 4 pole DIP switch is operated/switched, this device will not work as intended and it might be the cause of failure.
- Please handle the cables properly and DO NOT let them get damaged. Using damaged cables will not only interfere with the correct operation of this device but also might be the cause of a system failure.



Do

Fire
hazard

● Risk of Fire !



- Please tighten the screws and bolts with the specified torque. (Please refer to the inverter user's guide)
- Verify that none of the screws and bolts are loose.
- Make sure that the inverter and this device are fixed together with the securing screw.
- Make sure that the connectors are properly fixed.







Do

1.4.4 Precautions during operation!



 **Danger**

-  ● **Risk of an electric shock or fire !**
- Electric shock and Fire hazard**
- DO NOT touch the inside of this device, check the signal, do any wiring or plug/unplug the connectors while it energized.
 - DO NOT insert any sick or rod like objects inside this device while it is energized.
-  **Prohibited**

-  ● **Risk of an injury and/or fire !**
- Injury and Fire hazard**
- DO NOT touch the inside of this device or the inverter while they are energized.
-  **Prohibited**



-  ● **Risk of an electric shock !**
- Electric shock**
- Make sure to fasten all the screws of this device before turning it on. DO NOT detach this device while it is energized or the inverter capacitors are still charged.
 - Additionally DO NOT touch the inside of the inverter while the inverter capacitors are still charged.
 - DO NOT touch this device with wet hands.
-  **Prohibited**

 **Warning**

-  ● **Risk of an injury and/or device damage !**
- Injury or device Damage**
- By using this device it becomes easier to change the settings and the output frequency of the inverter. When changing the settings or the output frequency of the inverter please make sure that it is within the supported range by the motor and/or the equipment.
-  **Do**
-  **Do**
- In case this device is being used to make the inverter produce high frequency outputs for a motor or other equipment, make sure with the respective manufacturer that the motor or the equipment can tolerate the high frequency output given by the inverter.
 - During operation verify the motor rotation direction, and that there are no irregular sounds or vibrations.

1.4.5 Precautions during Maintenance / Inspection!

 **Danger**

-  ● **Risk of an electric shock !**
- Electric shock**
- Before the wiring work make sure to turn off the power supply and wait for more than 10 or 15 minutes depending on the inverter model(*). (Confirm that the charge lamp is OFF and the DC voltage between terminals P and N is 45 V or less)
-  **Do**
-  **Prohibited**
- Entrust the maintenance, inspection and/or part replacement only to a specialized personnel. (Be sure to remove wristwatches and metal accessories, e.g., bracelets, before maintenance and inspection work and use insulated tools for the work).

*) For P1-00044-L to P1-01240-L (P1-004L to P1-220L), P1-00041-H to P1-00620-H (P1-007H to P1-220H) models the wait time is 10 minutes.

For P1-01530-L to P1-02950-L (P1-300L to P1-550L), P1-00770-H to P1-03160-H (P1-300H to P1-1320H) models the wait time is 15 minutes.

1.4.6 Precautions for disposal !

**Danger**

● Risk of an injury and/or an explosion !

Injury
and
explosion
hazard

- Outsource to a qualified industrial waste disposal contractor when discarding this device. Disposing of this device on your own may result in the production of poisonous gas
- Contact Hitachi technical service or your sales agent if you need to get this device fixed.



Do

- A qualified waste disposer includes industrial waste collector/transporter and industrial waste disposal operator. Follow all laws and decrees related to procedures of waste management and public cleansing when disposing of this device.

1.4.7 Other Precautions

**Danger**

Electric
shock
injury
and Fire
hazard

● Risk of an injury, an electric shock and/or fire !

- DO NOT modify this device.



Prohibited

※In addition to the precautions described above, there are other precautions described in the chapter 8 of the inverter user's guide. Please read and follow those precautions as well.

1.5 Caution labels examples

- We include the caution label templates so motor, inverter or system related accidents or dangerous situations may be prevented. Please use these labels for your system or equipment.
- When the inverter is configured for remote operation, automatic operation or the retry function is active, there are cases when the operation will be resumed automatically after a shut down. In order to warn about this cases please use the label example on the right side as a reference.

(Label Template)

- Please fill in the label and use it for preventing accidents.

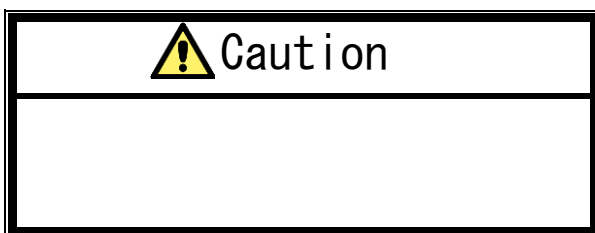

(Label example)

- For warning about automatically resumed operation after an error as a result of the retry function.

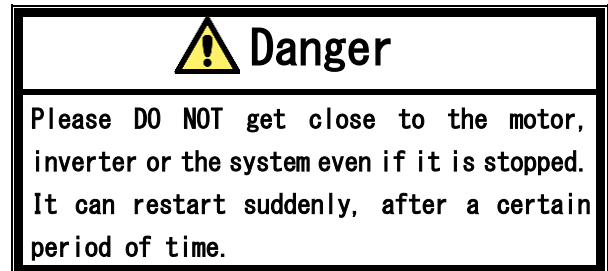

(Label example)

- For warning about remote or automatic operation after the system is powered on.

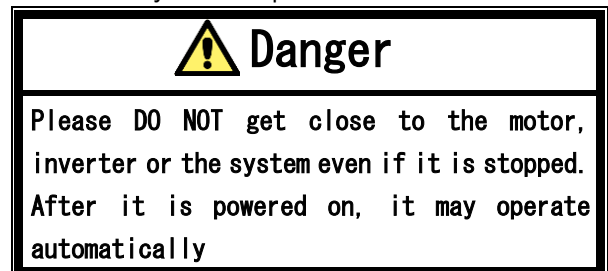

(Memo)

2

Chapter 2 Overview

Contents

2.1 About this chapter.....	2-1
2.2 Applicable devices.....	2-1
2.3 Before reading this guide.....	2-1
2.4 Guide objectives.....	2-1
2.5 Guide outline.....	2-2
2.6 Terminology	2-3
2.7 Symbol definition.....	2-3

2.1 About this chapter

This chapter specifies the devices that this guide will describe. Additionally, it contains information necessary to clearly understand this guide, the objectives of this guide and its terminology.

2.2 Applicable devices

The contents of this guide will apply to the P1-ECT device. For information about the inverter please refer to the inverter's user's guide or the basic guide.

2.3 Before reading this guide

This guide is aimed for people who purchase, handle, install or connect control equipment, design systems or manage factories.

This guide units are based on the SI system.

2.4 Guide objectives

The objectives of this guide are:

- explain how to wire and connect the device.
- explain how to set the necessary parameters.

2.5 Guide outline

This guide has the following structure.

- The Chapter 1 “Safety Precautions” , contains the safety instructions for installing, wiring, operating, maintaining and inspecting this device.
- The Chapter 2 “Overview” , contains information necessary to clearly understand this guide, the objectives of this guide and its terminology.
- The Chapter 3 “Preparing for Operation” , contains the instructions step by step for operating this device successfully.
- The Chapter 4 “About this Product” , contains the explanation about the product appearance and general features.
- The Chapter 5 “Enclosed Items” , contains information about the items enclosed with this device.
- The Chapter 6 “Installing and connecting” , contains information for installing the P1-ECT on the inverter.
- The Chapter 7 “Inverter Settings” , contains the explanation of the inverter parameters that relate with the P1-ECT.
- The Chapter 8 “About EtherCAT” , contains the EtherCAT explanation.
- The Chapter 9 “About the CiA402” , contains the CiA402 explanation.
- The Chapter 10 “Object Dictionary” , contains the explanation about the object dictionary.
- The Chapter 11 “FAQ and Troubleshooting” , contains the explanation of the P1-ECT LEDs lighting patterns, the explanation of inverter error (trip) status and its trouble shooting.
- The Chapter 12 “Specifications” , contains the specifications of the P1-ECT.

2.6 Terminology

※Alphabetical order

C

Term	Description
CoE	CAN application protocol over EtherCAT. Refers to the EtherCAT communication protocol. It is used in the object dictionary, PDO communication and SDO communication.
CiA402	Refers to the device profile for CANopen. It is the profile used as a driver.

E

Term	Description
EtherCAT	It is one of the open networks for industrial use. Standardized by the IEC 61158.
ESI file	EtherCAT slave information It is the xml file which contains the information of the EtherCAT slave.

M

Term	Description
MFG No.	Manufacture number.

O

Term	Description
Object	It is the device stored data. This data is identified with an index from 0x0000 to 0xFFFF. Each object can have up to 255 sub-indexes. In this guide the object index and sub-index are shown with a colon(:)mark between them. (e. g. 0x6046:01).
Object dictionary	It refers to the whole set of objects.

P



Term	Description
PDO	Process Data Object. It is data that is periodically sent or received through CoE.

S

Term	Description
SDO	Service Data Object It is data that is non-periodically sent or received through CoE. Only sent or received when requested.

2.7 Symbol definition

In this guide, there are some explanatory notes using the symbols shown in the table below. This table also contains the explanation of each symbol.

Symbol and its definition	Description
Questions about a particular situation. 	Simply describes some problematic or recurring situations. Hence, in cases when an occurring situation is similar to a situation described in this guide, it may be solved by using this guide information and the P1-ECT functions.
Solution/Answer 	Describes the settings and operations required in order to solve a particular problem or situation.
Precautions 	Describes the points of caution when using an indicated function. This descriptions contain information such as, data overwrite risk, indispensable settings, non-operation risk and other probable dangers.

(Memo)

Chapter 3

Preparing for Operation

3

Contents

3.1 About this chapter.....	3-1
3.2 Preparation steps.....	3-2
3.2.1 Step 1: Preparing the inverter.....	3-2
3.2.2 Step 2: Parameter setting.....	3-2
3.2.3 Step 3: Installing the P1-ECT.....	3-2
3.2.4 Step 4: Connect with EtherCAT.....	3-2
3.2.5 Step 5: Operate the inverter.....	3-3
3.2.6 Troubleshooting.....	3-3

3.1 About this chapter

This chapter contains the instructions step by step for operating this device successfully.

This chapter will refer to others chapters for more detail explanation. Hence for installation, mounting, wiring, operation setting and function detailed explanation, refer to the indicated or corresponding chapter. Additionally, when doing any work or operation, always follow the safety instructions and cautions given in the chapter 1.

3.2 Preparation steps

3.2.1 Step 1: Preparing the inverter

Follow the steps written in the inverter user's guide in order to prepare the inverter for operation.

Furthermore, configure the parameters related to the motor.

For more details refer to the inverter user's guide.

3.2.2 Step 2: Parameter setting

Configure the parameters related to the P1-ECT. The 2 parameters shown below must be configured before installing the P1-ECT on the inverter.

- [bA102] 1st motor upper frequency limit.
- [bA103] 1st motor lower frequency limit.

These parameters may not change properly after the P1-ECT is installed.

Additionally, keep in mind that when the P1-ECT is installed, and the [bA102] is set to 0.00 [Hz], it does not mean that the frequency upper limit is not effective but it means that the frequency upper limit is 0.00 [Hz].

The rest of the parameters can be configured without problem after the P1-ECT is installed.

For more information refer to the Chapter 7 "Inverter Settings" .

3.2.3 Step 3: Installing the P1-ECT

Turn OFF the inverter (refer to 1.4.3 for safety precautions), then install the P1-ECT.

For more information refer to the Chapter 6 "Installing, Wiring and Connecting" .

3.2.4 Step 4: Connect with EtherCAT

Install the P1-ECT ESI file into the EtherCAT master Configuration tool. Then configure this tool so the master and the P1-ECT can communicate through EtherCAT.

For more information refer to the Chapter 8 "About EtherCAT" .

3.2.5 Step 5: Operate the inverter

The inverter can be operated by changing the objects 0x6040 Controlword and the 0x6042 v1 target velocity settings.

If the steps described above were followed correctly, the objects 0x6041 Statusword, 0x6043 v1 velocity demand, and the inverter frequency output will change as shown in the table below

For more information refer to the Chapter 9 “About CiA402” .

■ Parameter setting value and monitor values

(in case the number of poles is 4)

0x6040 Controlword	0x6042 v1 target velocity [rpm]	0x6041 Statusword	0x6043 v1 velocity demand [rpm]	Output Frequency [Hz]
0x0000	0	0x0240	0	0.00
0x0006	0	0x0221	0	0.00
0x000F	0	0x0237	0	0.00
0x000F	1800	0x0237	Accelerate from 0 to 1800	Forward accelerate until 60.00
0x000F	0	0x0237	Decelerate from 1800 to 0	Decelerate until 0.00
0x000F	-1800	0x0237	Accelerate from 0 to -1800	Reverse accelerate until 60.00
0x0000	-1800	After it stops 0x0240	Decelerate from -1800 to 0	Decelerate until 0.00 then it stops the operation

3.2.6 Troubleshooting

I want to know more about the object dictionary!
Refer to the chapter 10 “Object dictionary” .

The motor does not rotate!
The inverter is showing an error!
Refer to the chapter 11 “FAQ and
Troubleshooting” .

(Memo)

4



Chapter 4 About the P1-ECT

Contents

4.1 About this chapter.....	4-1
4.2 External features.....	4-2
4.2.1 P1-ECT appearance and nomenclature..	4-2
4.2.2 Address setting switch.....	4-3
4.2.3 LED	4-4
4.2.4 IN/OUT Port.....	4-5
4.3 Name plate	4-6
4.4 Dimensions after installed.....	4-6

4.1 About this chapter

This chapter contains the explanation about this product external features and information on the name plate. It is recommended to check this chapter contents and verify the device after the purchase.

Symbol	Definition
	Questions about a particular situation.
	Solution/Answer
	Precautions

4.2 External features

4.2.1 P1-ECT appearance and nomenclature

Q

• I need to know the external features of the P1-ECT.

!

• The four LEDs over the RJ-45 connection don't turn on or blink.

A

• The P1-ECT external view is shown below.

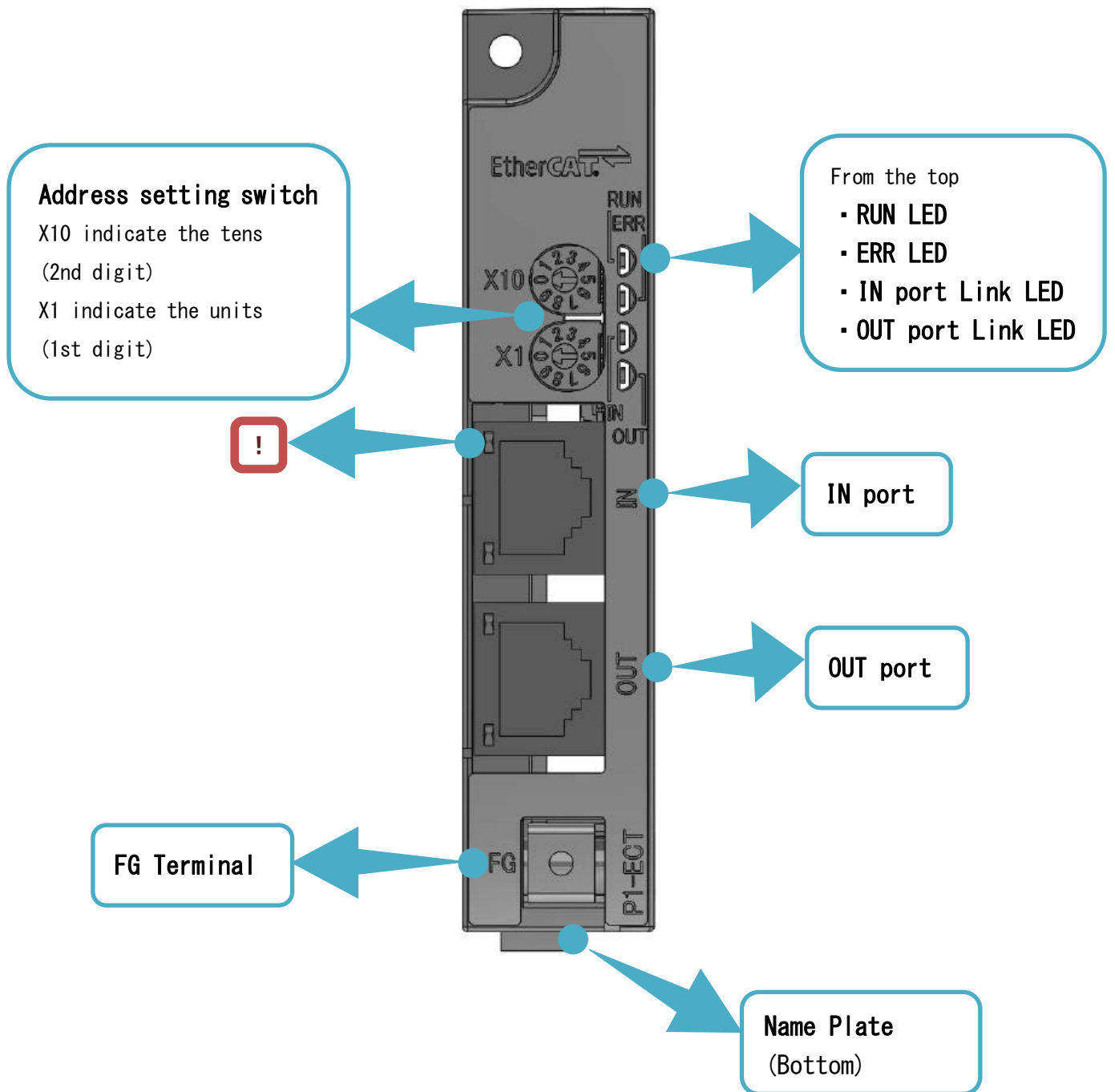

4.2.2 Address setting switch

Q

- Is it necessary to set up the station address with the address setting switch?

A

- It depends on the addressing mode used by the EtherCAT master. When the fixed addressing mode is being used, it is necessary to configure the station address using the address setting switch.
- When Auto Increment Addressing or Logical Addressing are being used, the master will set up the slave address, hence it is not necessary to configure the station address with the address setting switch. In these cases the address setting switch will have no effect.

Q

- How do I set up the station address using the address setting switch?

A

- The upper rotary switch(X10) determine the tens(2nd digit) of the address while the lower rotary switch(X1) will determine the units (1st digit) of the address. Therefore, the range of the station address will be from 00 to 99.
- The address configured by address setting switch will become effective after the device is turn on. While the power is on, any change on the address setting switch will be ineffective. Thus, any change will only become effective after the device is turn on again.
- Additionally, if a station address is overlapped or repeated inside the same EtherCAT network there will be an abnormality and the EtherCAT will not transmit properly.

4.2.3 LED



• What do the LEDs show?



• The P1-ECT LEDs are explained in the table below.

LED definition

LED	Color	Lighting pattern	Description
RUN	Green	Light off	Initial status.
		Blinking	Pre-Operational status.
		Single flash	Safe-Operational status.
		Light on	Operational status.
ERR	Red	Light off	No problem detected.
		Blinking	There is a problem with the transmission.
		Double flash	There is a problem with the EtherCAT connection.
LINK LED (IN/OUT)	Green	Light off	Link not established.
		Light on	Link established, but no transmission.
		Flickering	Link established, and transmitting.

LED Lighting patterns

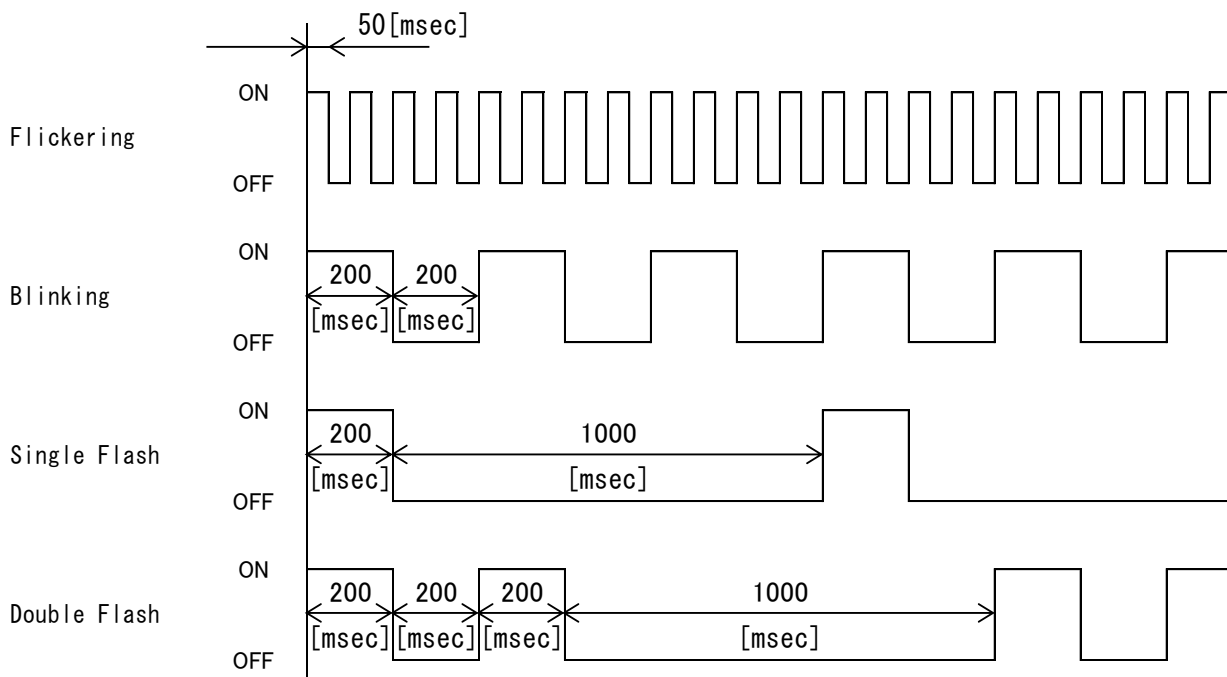

4.2.4 IN/OUT Port

Q

• I need to know the connector specifications.

A

• The P1-ECT connector specifications are shown below.

■ Connector Specifications

Connector Type	Notes
RJ-45	Its electric characteristics conform to the IEEE802.3 standard. It supports category 5e or higher.

■ Pin arrangement

Pin No	Notation	Signal Type
1	TD+	Transmit data +
2	TD-	Transmit data -
3	RD+	Receive data +
4	-	
5	-	
6	RD-	Receive data -
7	-	
8	-	

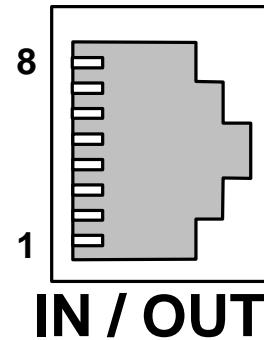

Q

• I want to know the necessary specifications for the communication cable.

A

• An Ethernet twist pair cable(category 5e or higher) is used for the connection. It is recommended to use a cable with the following specifications.

■ Cable recommended specifications

Item Name	Description
Twist pair cable	100BX-TX support (category 5e or higher) STP(Shield twist pair) cable (Straight or Crossed). The P1-ECT supports the Auto MDI-X function which detects the cable connection type and configures the connection type accordingly.

4.3 Name plate

Q

• What is the information written on the name plate?

A

• The image below The P1-ECT name plate gives the following information.

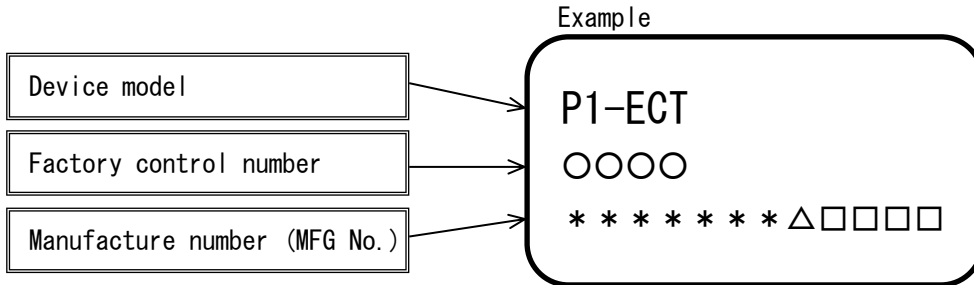

4.4 Dimensions after installed

Q

• What are the P1-ECT dimensions after being installed?

!

• As shown on the image a part of the P1-ECT will stand out from the SJ-P1. Please be cautious when installing the device.

A

• The dimensions of the P1-ECT after it is installed on the SJ-P1 are shown in the image below

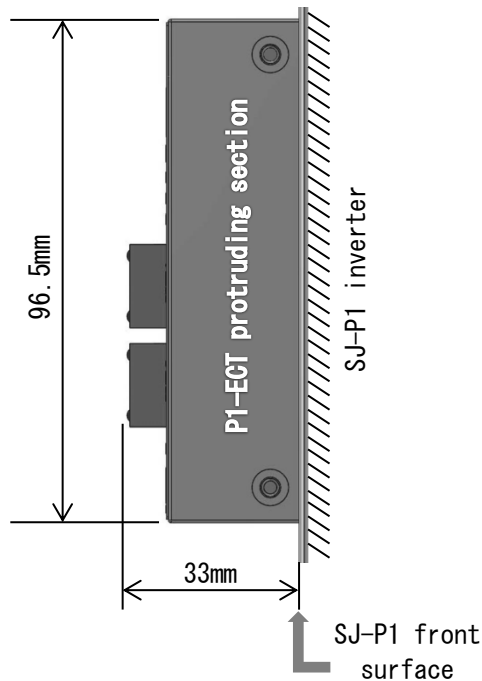

View from the right side of the SJ-P1.

5



Chapter 5 Enclosed Items

Contents

5.1 About this chapter.....	5-1
5.2 About the enclosed items.....	5-2
5.3 Verification after the purchase.....	5-3
5.3.1 Verification when unpacking.....	5-3
5.3.2 Read this guide.....	5-3

5.1 About this chapter

This chapter contains information about the items enclosed with the P1-ECT. Additionally, it is explained how to inspect and verify this product after its purchase.

Symbol	Definition
	Questions about a particular situation.
	Solution/Answer
	Precautions

5.2 About the enclosed items



• What items are enclosed?

• Enclosed items



P1-ECT x1



Basic Guide x1



• The enclosed items are shown on the images below.



Ferrite Core x2

■ Ferrite Core Specification

Item Name	Manufacturer	Model	Inner Diameter
Ferrite Core	SEIWA ELECTRIC MFG. Co., Ltd	E04SR200935A	9 [mm]



Contact your sales agent immediately in case there are defects or imperfections.

5.3 Verification after the purchase





- What should I verify after the purchase?



5.3.1 Verification when unpacking

- Please verify the items written on the right when unpacking.
- In case there is any doubt or trouble with the product please contact your sales agent as soon as possible.

 Check that the items were not smashed or damaged during the delivery.

 Check that there is a P1-ECT, there is a Basic Guide, there are 2 ferrite cores, when unpacking.

 Please check again that your order match with the name plate of the device.

5.3.2 Read this guide

- This guide contains the information necessary to handle the P1-ECT correctly. Read it carefully and keep it safe.
- Also, use the inverter user's guide and basic guide as a reference.
- Please make sure that the P1-ECT basic guide and the inverter basic guide reach the end user. Additionally, advice the end user to download and read the latest version of this guide.

(Memo)

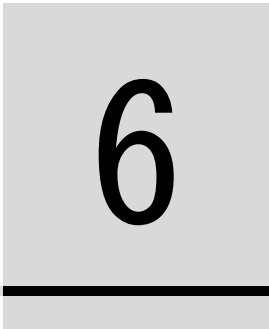

Chapter 6

Installing and Connecting

Contents

- 6.1 About this chapter..... 6-1
- 6.2 Supported inverters..... 6-2
- 6.3 Installation..... 6-2
 - 6.3.1 About the installation..... 6-2
 - 6.3.2 How to install..... 6-3
- 6.4 Attach the ferrite cores..... 6-4
- 6.5 About the connection..... 6-5

6.1 About this chapter

This chapter contains information for installing the P1-ECT on the inverter.

For information about the inverter installation please refer to the inverter user’s guide.

Symbol	Definition
	Precautions

6.2 Supported inverters

The P1-ECT can be attached to all types of SJ-P1. However, depending on the SJ-P1 manufacture date, it might not support the P1-ECT. Please check the version of the inverter which is written on the name plate of it (the name plate example is shown on the image to the right). If the version is 2.00 or higher it can support the P1-ECT.

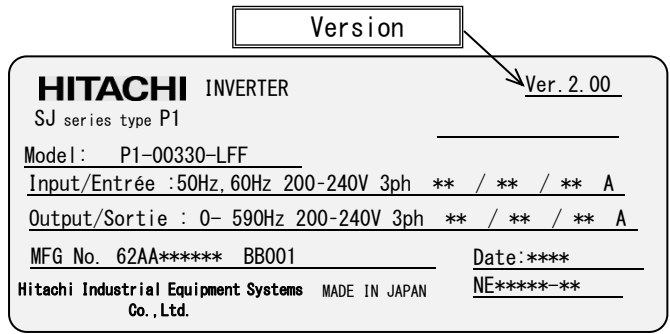

6.3 Installation

6.3.1 About the installation

The P1-ECT can be attached to any of the 3 option slots of the SJ-P1 inverter.

It can be attached to either SLOT1, 2 or 3.

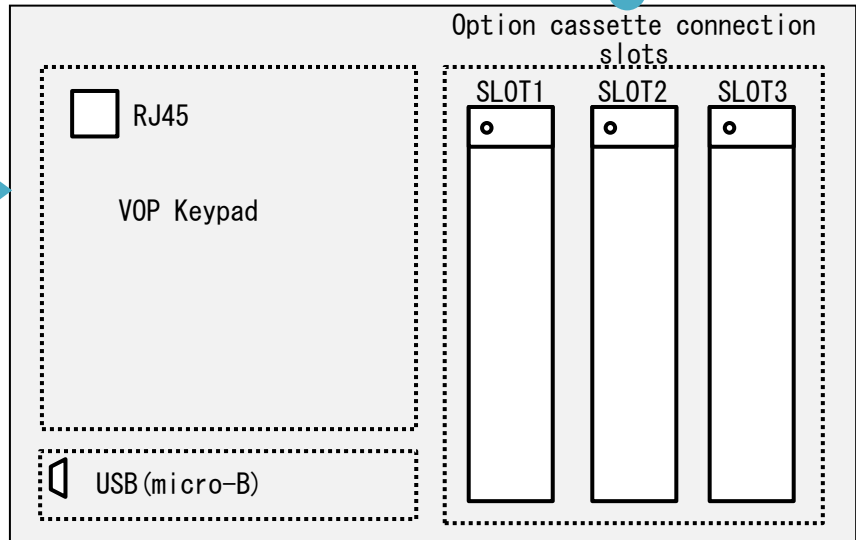
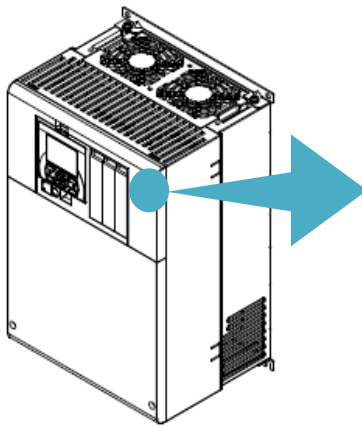

6.3.2 How to install

Before installing the P1-ECT please refer to the chapter 7 “Inverter Setting” and configure the inverter.

For explanation purposes, it will be assumed that the P1-ECT is going to be installed in the SLOT1.

- (1) Remove the cover of the option cassette connection slot. Despite the removed cover will no longer be needed, it is recommended to keep it in a safe place. However the screw that secured the cover will be used to secure the P1-ECT.

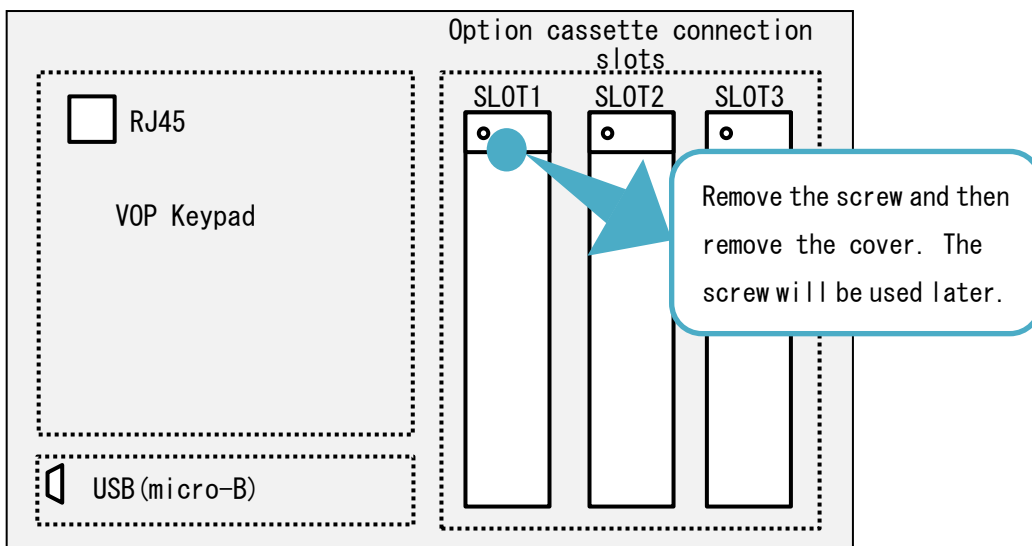

- (2) Attach the P1-ECT. The slots 2 and 3 have one more connection in the lower side. However, the P1-ECT will not need that connection.

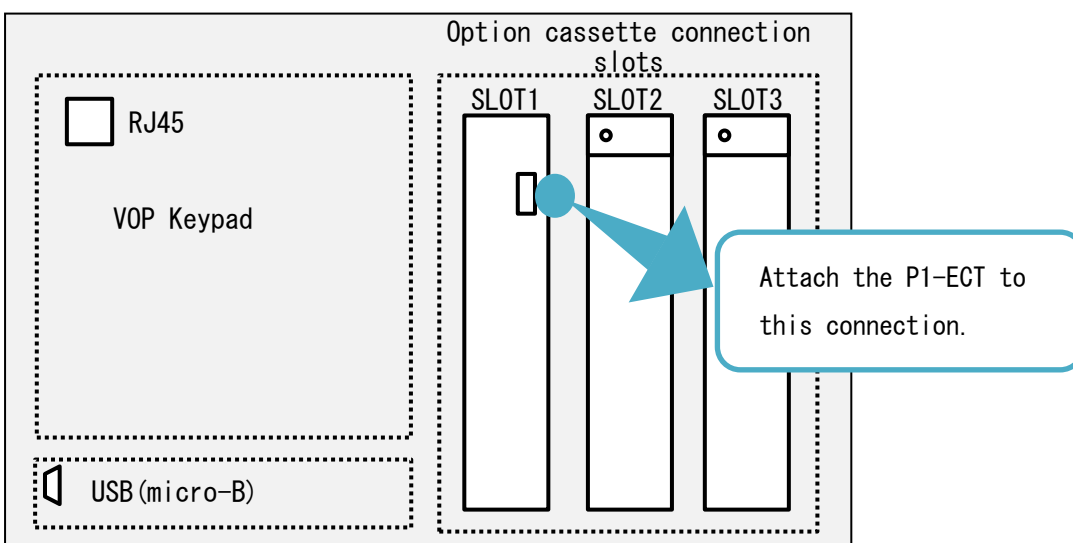

(3) Secure the P1-ECT with the screw removed in procedure (1).

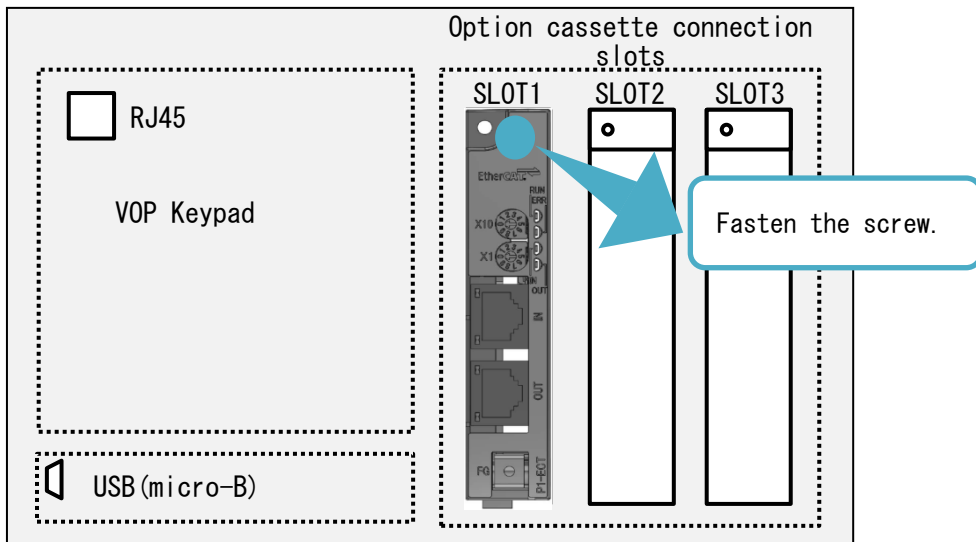

(4) Connect the FG terminal to functional ground.

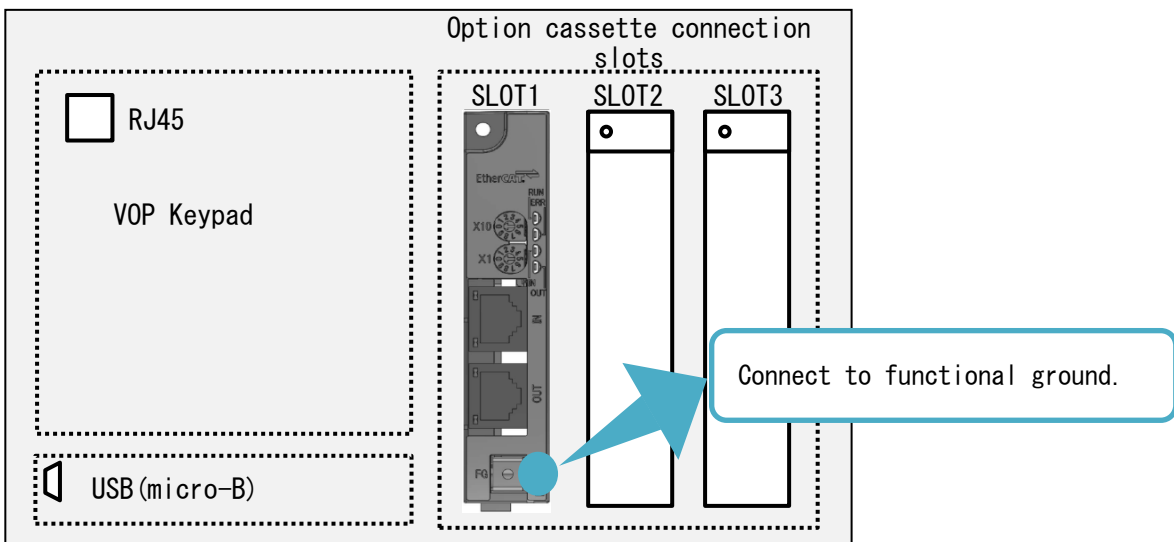

6.4 Attach the ferrite cores

Attach the included ferrite cores to the EtherCAT cable. These cores should be attached as close as possible to the P1-ECT RJ-45 connection.



Depending on the EtherCAT cable the ferrite core cannot be correctly fixed to the cable and it may slip along the cable, despite having an anti-slip claw. In these cases the ferrite core can be fixed by attaching something like a clamping band or a wire to the EtherCAT cable on one or both sides of the ferrite core. Keep in mind that the cores should be attached as close as possible to the P1-ECT RJ-45 connection.

6.5 About the connection

- Make sure that the communication line and the power line are placed as far as possible from each other. If the power line and the communication line are placed close to each other, the communication line will pick up noise from the power line that can interfere with the transmission.
- Make sure to set up the system, so that in an event of a network failure, the inverter output stops immediately.
 - (1) In case the master detects an abnormality in the connection, shut down the inverter primary power supply.
 - (2) Allocate functions such as “free run” or “reset” to the input terminals, so when the master detects a connection abnormality it is capable of turning on these terminals.
 - (3) Configure the inverter so in case of a connection abnormality, it stops, free run stops or trip. (When the operation command is received through EtherCAT, the inverter shipment settings are configured so that if there is any abnormality in the connection the inverter will immediately stop)



Connect the communication cable (Ethernet cable), so it minimizes the tension and stress over the connector.

For other information concerning the installation, please refer to the inverter user's guide.

(Memo)

7

Chapter 7 Inverter Settings

Contents

7.1 About this chapter.....	1
7.2 Parameter settings.....	2
7.2.1 Parameters that must be configured...	2
7.2.2 Parameters that must be set as required by the application.....	2
7.2.3 Parameters correlating the Inverter and the P1-ECT.....	3
7.2.4 Other parameters.....	4

7.1 About this chapter

This chapter contains the information about the inverter settings that must be done when using the P1-ECT.

Symbol	Definition
	Precautions

7.2 Parameter settings

This chapter explains how to configure the SJ-P1 inverter parameters in order to use the P1-ECT. Any setting change on the following parameters will be effective immediately after the change (please read the precautions on the right side).



- The [bA102] and [bA103] parameters must be configured before installing the P1-ECT on the inverter.

Since these 2 parameters are read and write by the P1-ECT periodically, trying to set them from the VOP might not be effective after the P1-ECT is installed.

7.2.1 Parameters that must be configured

List of parameters.

Item	Parameter No	Data	Description	Caution
Main speed input source selection, 1st motor	[AA101]	9 (Option-1) 10 (Option-2) 11 (Option-3)	Select the slot in which the P1-ECT was installed.	
Run-command input source selection, 1st motor	[AA111]	4 (Option-1) 5 (Option-2) 6 (Option-3)		
Upper Frequency limit, 1st motor	[bA102]	0.00~ 590.00 (Hz)	Set the frequency upper limit. When using the P1-ECT, 0.00 [Hz] does not mean that the frequency upper limit is not effective but it means that the frequency upper limit is 0.00 [Hz].	

7.2.2 Parameters that must be set as required by the application.

List of parameters.

Item	Parameter No	Data	Description	Caution
Deceleration time setting 2, 1st motor	[AC126]	0.00~ 3600.00 (s)	Set the Quick stop deceleration time. This parameter setting is needed in case the Quick stop function is going to be used.	
Lower Frequency limit, 1st motor	[bA103]	0.00~ 590.00 (Hz)	Set the frequency lower limit.	
Acceleration time (Keypad)	[FA-10]	0.00~ 3600.00 (s)	Set the acceleration time.	
Deceleration time (Keypad)	[FA-12]	0.00~ 3600.00 (s)	Set the deceleration time.	

7.2.3 Parameters correlating the Inverter and the P1-ECT

The parameters described in the following table control the action taken by the inverter when there is a problem with the P1-ECT or when the P1-ECT is connected.

Parameter

Code	Parameter name	Selection	Initial value
oA-10	Operation mode on option card error (SLOT-1)	00(Error)/ 01(Ignore error (Keep running))	00
oA-20	Operation mode on option card error (SLOT-2)	00(Error)/ 01(Ignore error (Keep running))	00
oA-30	Operation mode on option card error (SLOT-3)	00(Error)/ 01(Ignore error (Keep running))	00

- [oA-10]: Operation mode on option card error (SLOT-1)
- [oA-20]: Operation mode on option card error (SLOT-2)
- [oA-30]: Operation mode on option card error (SLOT-3)

These parameters can select whether to ignore the option error trip or not in cases where there are connection failures between the P1-ECT and the inverter.

Let the inverter trip: 00 (error).

Ignore the error and continue with the operation: 01(Ignore error (Keep running)).

Please make sure to configure the parameter corresponding to the slot in which the P1-ECT is attached.



In the event there is a communication failure between the inverter and the P1-ECT, and the option 01 (Ignore error (Keep running)) is selected, the inverter operation will not stop. Additionally, in case there is a communication failure between the P1-ECT and the inverter, the higher-level device (master) stop command will not be received. Thus, safety measures and precautions are recommended.

7.2.4 Other parameters

In addition to the configurations explained in sections 7.2.2 and 7.2.3, please verify the configuration of the following parameters when using the P1-ECT.

- [CF-11]: Function for transforming the register data from A, V to %

When using the P1-ECT please select the 00(A, V) setting.

- [oA-11]: Communication Watch Dog Timer (SLOT-1)
- [oA-21]: Communication Watch Dog Timer (SLOT-2)
- [oA-31]: Communication Watch Dog Timer (SLOT-3)

These settings are unavailable for this device. Please do not change the setting.

- [oA-12]: Action selection at communication error (SLOT-1)
- [oA-22]: Action selection at communication error (SLOT-2)
- [oA-32]: Action selection at communication error (SLOT-3)

These settings are unavailable for this device. Please do not change the setting.

- [oA-13]: Run command selection at start up (SLOT-1)
- [oA-23]: Run command selection at start up (SLOT-2)
- [oA-23]: Run command selection at start up (SLOT-3)

Please do not change these settings

8

Chapter 8 About EtherCAT

Contents

8.1 About this chapter.....	8-1
8.2 ESI File	8-2
8.3 CANopen over EtherCAT.....	8-2
8.4 EtherCAT state transition.....	8-3
8.5 PDO communication.....	8-4
8.6 SDO communication.....	8-4
8.7 Emergency messages.....	8-5

8.1 About this chapter

This chapter contains a general explanation about EtherCAT.

8.2 ESI File

In order to use the P1-ECT, it is necessary to install the P1-ECT ESI file into the EtherCAT master Configuration tool. The ESI file is an xml file that has the specific information of the EtherCAT slave device.

The ESI file can be obtained through our website. In case is not available or cannot be downloaded please contact the nearest sales office.

8.3 CANopen over EtherCAT

The P1-ECT uses the CAN application protocol over EtherCAT (CoE).

CoE provides PDO (Process Data Objects) and SDO (Service Data Objects) communication mechanisms. The PDO is an object dictionary that can be mapped, and it transmits processed data periodically. The SDO can read and write the whole object dictionary and transmits data when requested.

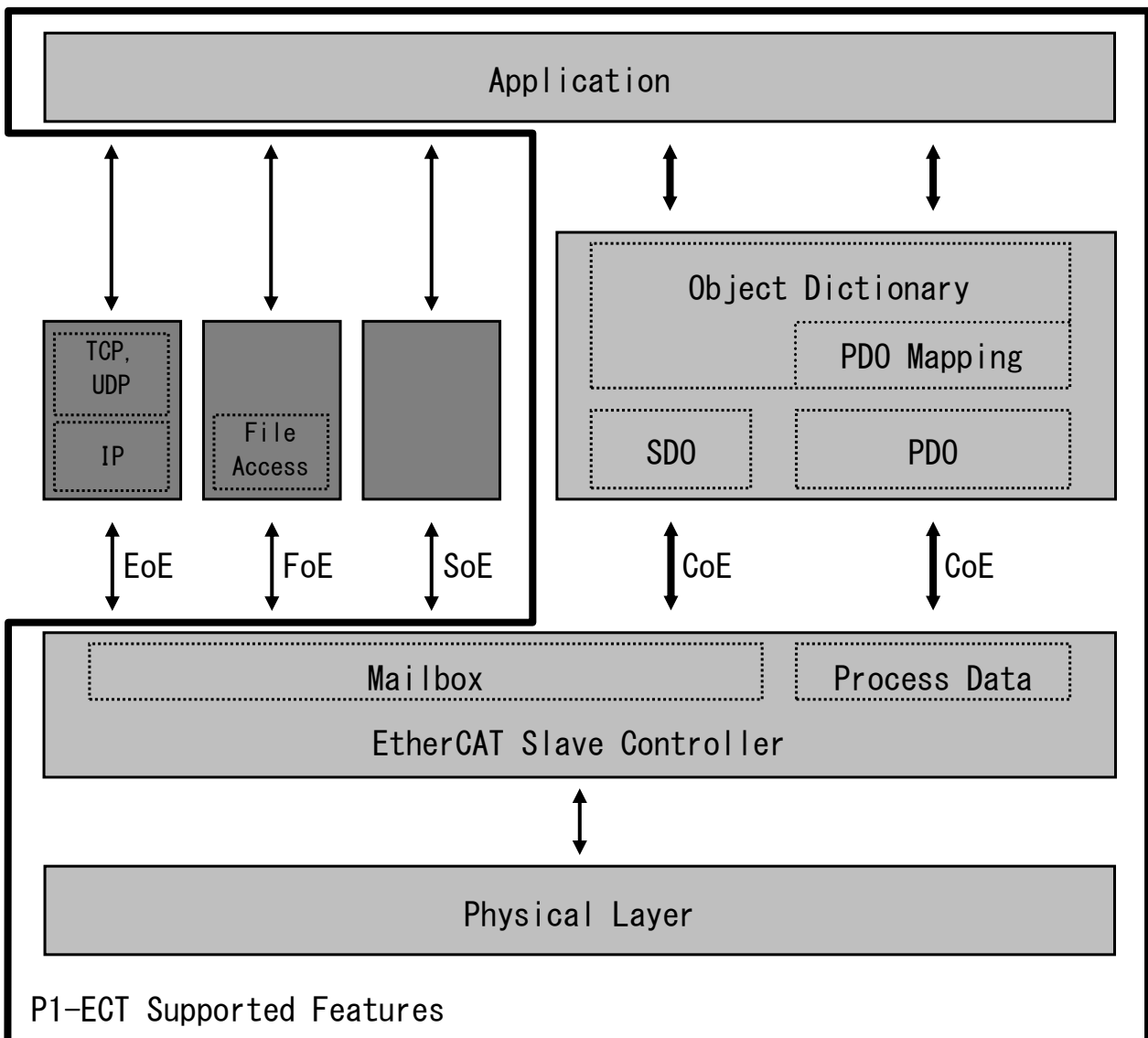

8.4 EtherCAT state transition

EtherCAT state machine (ESM) describes the communication state of each EtherCAT slave device. The ESM is controlled by the master. The PDO and SDO communications will be enabled or disabled depending on this communication states.

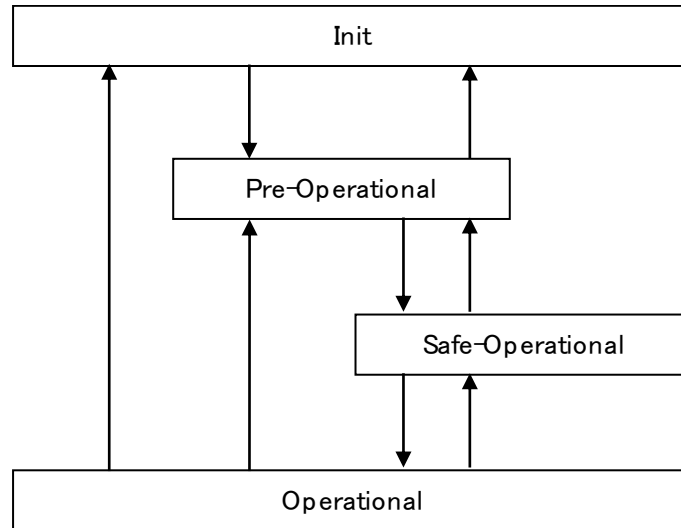

State	Description	SDO communication	PDO communication
Init	The communication is initializing. In this state there will be no communication.	Disable	Disable
Pre-Operational	Only the SDO communication will be enabled. The communication state will change automatically to this state after the initialization, and the master will configure the slaves.	Enable	Disable
Safe-Operational	In addition to the SDO communication, the PDO sending (TxPDO) is enabled.	Enable	Enable (TxPDO only)
Operational	Normal state. All communications are enabled.	Enable	Enable

8.5 PDO communication

The P1-ECT uses the objects indicated below in the PDO mapping. Both RxPDO and TxPDO can register up to 12 objects by using 1600h, 1605h, 1A00h, and 1A05h.

RxPDO is data coming from the master and received by the P1-ECT.

TxPDO is data transmitted by the P1-ECT to the master.

Index	Description	Details
0x1600	RxPDO mapping (variable)	It can freely allocate up to 10 objects that are enabled for RxPDO mapping.
0x1605	RxPDO mapping (fixed)	The following objects are allocated by default. They cannot be changed. <ul style="list-style-type: none"> • 0x6040 (Controlword) • 0x6042 (vl target velocity)
0x1A00	TxPDO mapping (variable)	It can freely allocate up to 10 objects that are enabled for TxPDO mapping.
0x1A05	TxPDO mapping (fixed)	The following objects are allocated by default. They cannot be changed. <ul style="list-style-type: none"> • 0x6041 (Statusword) • 0x6043 (vl velocity demand)

8.6 SDO communication

The SDO communication is a communication that goes through the mailbox, and it only transmits when there is a specific request from or to a slave. The abort codes for SDO communication failure are shown below.

■ SDO Abort code

Code	Definition
0x06010001	Attempt to read a write only object
0x06010002	Attempt to write a read only object
0x06020000	Object does not exist in the object dictionary
0x06040041	The object cannot be mapped into a PDO
0x06090011	Subindex does not exist
0x06090030	The parameter value range exceeded (only for write access)
0x06090031	The parameter value is too high
0x08000000	General error
0x08000020	The data cannot be transferred/saved to the application. Please verify that the inverter is not in a write disabled status.

8.7 Emergency messages

When an error or a warning occurs, an emergency message is sent to the mailbox in order to notify the master about the situation. In case of a communication failure or abnormality an emergency message will not be sent.

By configuring the object (0x10F3): Diagnostic History, it can be selected whether to send an emergency message or not. The factory default setting (10F3h, Subindex: 05h (Flag) = '1') is to send emergency messages.

In order to disable the emergency messages, change the 0x10F3 Subindex: 0x05 (flag) to "0". Afterwards use the object 1010h to write this setting on the Flash memory, otherwise it will return to its default value after the power is turn off and on again. For more information about the object 0x1010 please refer to the chapter 10 "Object Dictionary".

■ Data structure

An emergency message consists of 8 bytes of data.

Byte	0	1	2	3	4	5	6	7
Content	Error Code		Error Register (object 0x1001)	Manufacturer specified error field(reserved)				

■ Error code

Error code	Description	Solution
0x7500	There is a connection failure with the P1-ECT and the master.	An EtherCAT communication error occurred ·Is the cable length appropriate?(max. 100[m]) ·Is the cable disconnected or loose? ·Is there a lot of noise?
0xFF00	An inverter warning occurred.	There is an SJ-P1 warning code stored in the manufacturer specified field. Find the cause and solve it.
0xFF01	An inverter trip occurred.	There is an SJ-P1 trip code stored in the manufacturer specified field. Check if the CiA402 changed its state to "Fault". Then find and solve the cause of the trip. Afterwards, turn on the bit 7: Fault reset of the object 0x6040(Control word)
0xFF02	The P1-ECT is being used with a non supported inverter.	There is an SJ-P1 option I/F version information stored in the manufacturer specified field.
0xFF03	Flash memory data error	The diagnosis history or the parameter data cannot be saved because the Flash memory has reached its life span. Please replace the P1-ECT.

(Memo)

9



Chapter 9 About the CiA402

Contents

9.1 About this chapter.....	9-1
9.2 CiA402 state transition.....	9-2
9.3 0x6040 Controlword.....	9-3
9.4 0x6041 Statusword.....	9-4
9.5 Operation mode.....	9-4
9.6 Velocity mode.....	9-5
9.6.1 0x6042 vl target velocity.....	9-6
9.6.2 0x6043 vl velocity demand.....	9-6
9.6.3 0x6044 vl velocity actual value....	9-6
9.6.4 0x6046 vl velocity min max value...	9-6
9.6.5 0x6048 vl velocity acceleration....	9-6
9.6.6 0x6049 vl velocity deceleration....	9-6
9.6.7 0x604C vl dimension factor.....	9-6
9.7 Application Example.....	9-7

9.1 About this chapter

This chapter contains the explanation about the CiA402 and the Velocity mode of the profile.

Symbol	Definition
	Questions about a particular situation.
	Solution/Answer

9.2 CiA402 state transition

The P1-ECT state transition is shown in the following chart. In this chart, the boxes represent states and the numbers 2 to 12 and 15 represents commands.

The commands are given through the object 0x6040 setting. The states are shown by the object 0x6041.

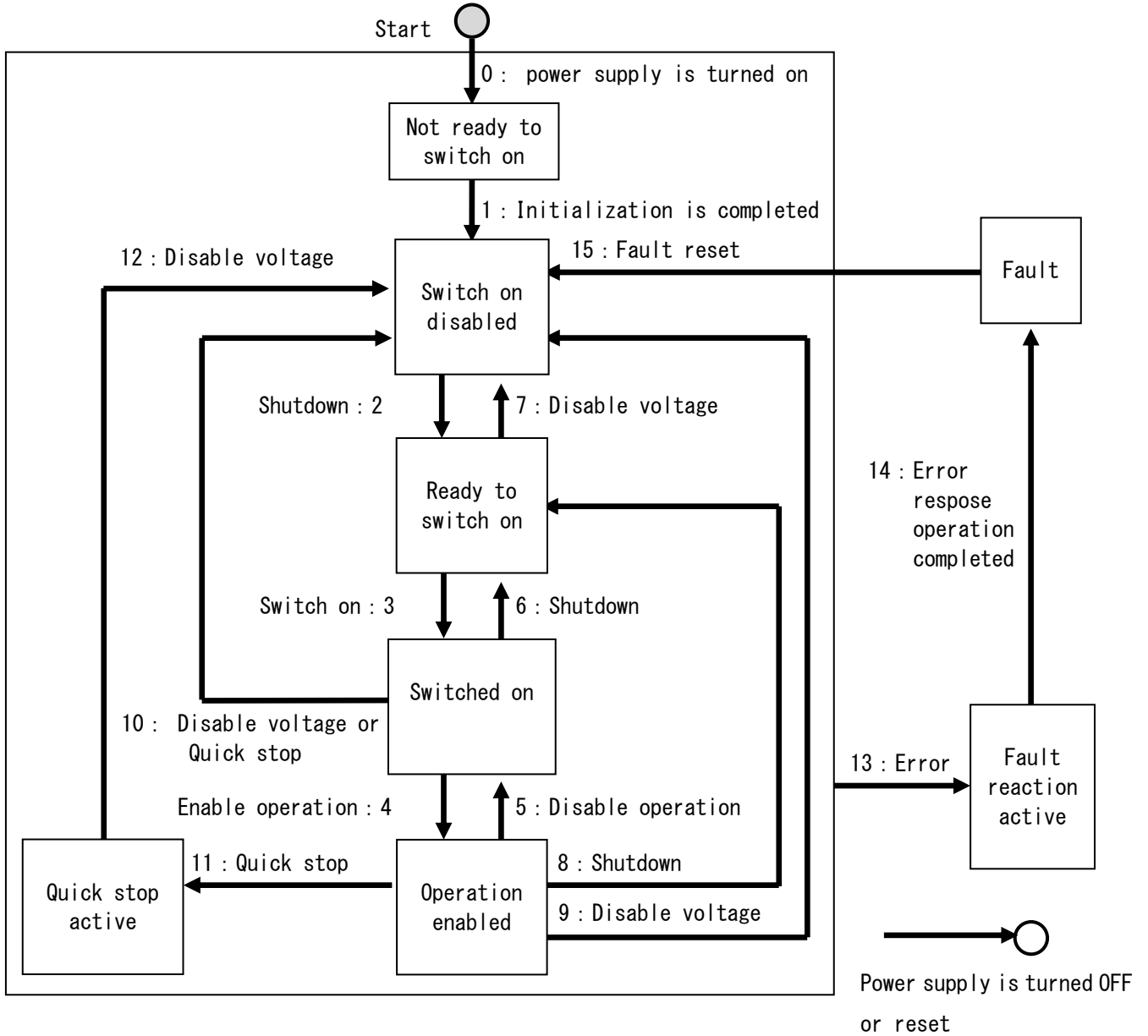

■ State Description

State	Description
Not ready to switch on	The power supply had been turned on but it is initializing.
Switch on disabled	The initialization was completed. The inverter and the P1-ECT parameter configuration is enabled.
Ready to switch on	The inverter and the P1-ECT parameter configuration is enabled.
Switched on	The inverter and the P1-ECT parameter configuration is enabled.
Operation enabled	The inveter can be controlled. The inverter and the P1-ECT parameter configuration is enabled.
Quick stop active	The inveter can be controlled. The inverter and the P1-ECT parameter configuration is enabled.
Fault reaction active	And error occurred in the inverter and the cause is beind determined. The inverter and the P1-ECT parameter configuration is enabled.
Fault	There is an error in the inverter. The inverter and the P1-ECT parameter configuration is enabled.

9.3 0x6040 Controlword

The states are controlled by the arrangement of the object 0x6040 (Controlword) bits. The bit arrangement is shown in table below.

The definition of each bit is shown in the table below.

Controlword	Bits 15~8	Bit 7	Bits 6~4	Bit 3	Bit 2	Bit 1	Bit 0
Definition	reserved	fr	reserved	eo	qs	ev	so

NOTE: fr = fault reset, eo = enable operation, qs = quick stop, ev = enable voltage, so = switch on,

The commands are created by the combination of the values of each bit. The commands and their respective bit value combinations are shown in the table below.

Command	Controlword bit					Transition
	Bit 7 fr	Bit 3 eo	Bit 2 qs	Bit 1 ev	Bit 0 so	
Shutdown	0	X	1	1	0	2, 6, 8
Switch on	0	0	1	1	1	3
Switch on + enable operation	0	1	1	1	1	3+4* ¹
Disable voltage	0	X	X	0	X	7, 9, 10, 12
Quick stop	0	X	0	1	X	7, 10, 11
Disable operation	0	0	1	1	1	5
Enable operation	0	1	1	1	1	4
Fault reset	0→1* ²	X	X	X	X	15

NOTE: X=don't care.

*1. The state automatically transitions to the Enable operation state after the Switch on state.

*2. It will execute the Fault reset command when the bit 7 is changed from 0 to 1.

Please set to 0 the 15 to 8 bits and the 6 to 4 bits

9.4 0x6041 Statusword

The states are indicated by the arrangement of the object 0x6041 (Statusword) bits.

The definition of each bit is shown in the table below.

Statusword	Bits 15~12	Bit 11	Bit 10	Bit 9	Bit 8	Bit 7
Definition	reserved	ila	reserved	rm	reserved	w

Statusword	Bit 6	Bit 5	Bit 4	Bit 3	Bit 2	Bit 1	Bit 0
Definition	sod	qs	ve	f	oe	so	rtso

NOTE: ila: internal limit active, rm: remote, w: warning, sod = switch on disabled, qs = quick stop, ve = voltage enabled, f = fault, oe = operation enabled, so = switched on, rtso = ready to switch on

The bit arrangement is shown in table below.

Status	Bit 6 sod	Bit 5 qs	Bit 4 ve	Bit 3 f	Bit 2 oe	Bit 1 so	Bit 0 rtso
Not ready to switch on	0	X	X	0	0	0	0
Switch on disabled	1	X	X	0	0	0	0
Ready to switch on	0	1	X	0	0	0	1
Switched on	0	1	X	0	0	1	1
Operation enabled	0	1	X	0	1	1	1
Quick stop active	0	0	X	0	1	1	1
Fault reaction active	0	X	X	1	1	1	1
Fault	0	X	X	1	0	0	0

Bit 7 (warning) will be ON while there is an inverter warning (dE-50 different than 0)

Bit 9 (remote) will turn OFF in the following cases:

- When one or both of the parameters AA101 (main speed input selection 1st motor) or AA111 (Run command input source selection 1st motor) setting does not match with the slot in which the P1-ECT is attached. E.g. The P1-ECT is attached to the slot 1 but the AA101 or the AA111 setting is configured for the slot 2
- When the input CF1 (multi speed selection 1) is being used.
- When the F-OP function is used and one or both of the parameters CA-70 ([F-OP] speed input selection) or CA-71 ([F-OP] run command input source) setting does not match with the slot in which the P1-ECT is attached.
- The P1-ECT cannot communicate with the inverter.

Bit 11 (internal limit active) will turn ON when the value of the object 0x6042 (vl target velocity) exceeds the range set by the object 0x6046 (vl velocity min/max amount)

9.5 Operation mode

The operation mode supported by the P1-ECT is the velocity mode.

9.6 Velocity mode

With the velocity mode, the inverter output speed can be controlled.

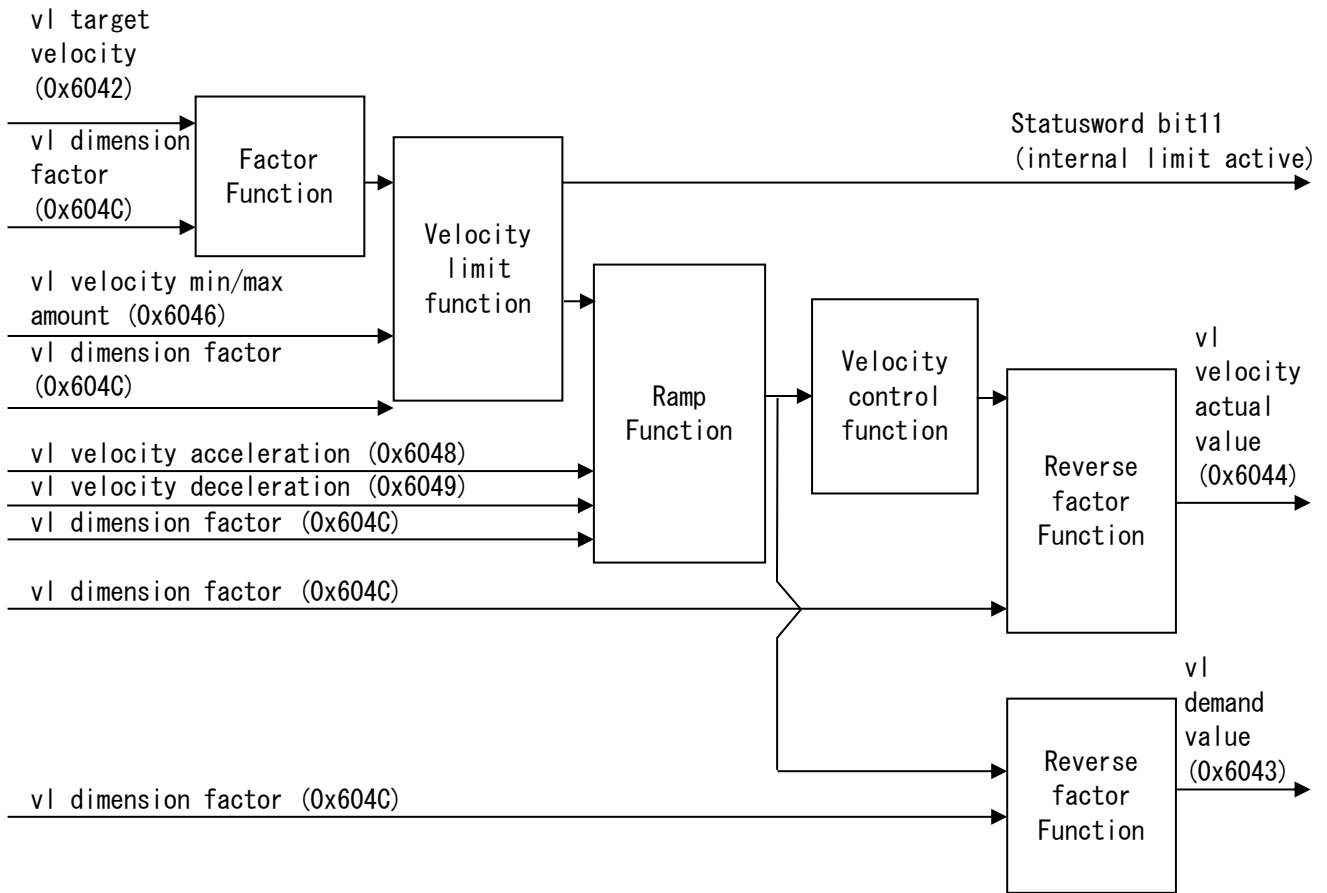

Factor Function

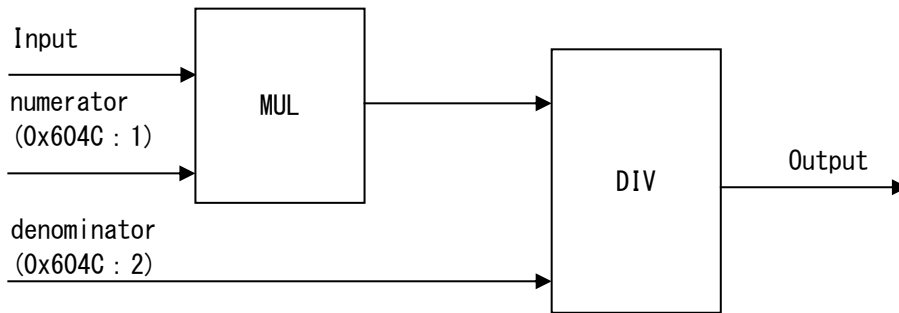

Reverse factor Function

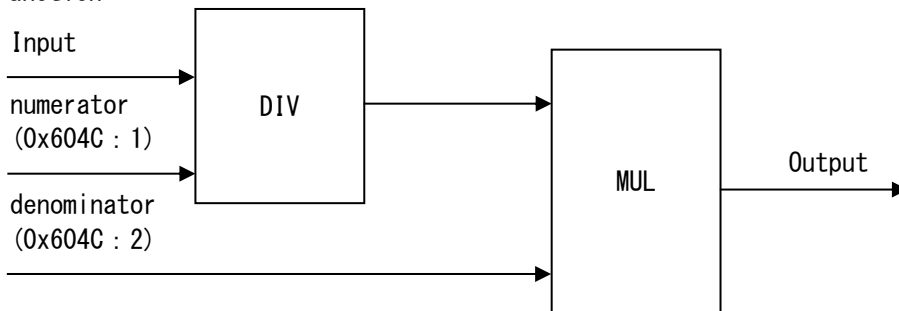

Item	Object name	Definition
0x6040	Controlword	Give commands to the inverter.
0x6041	Statusword	Display the inverter status.
0x6042	vl target velocity	Give the speed command to the inverter.
0x6043	vl velocity demand	Display the operation speed.
0x6044	vl velocity actual value	Display the output speed.
0x6046	vl velocity min max amount	Set and display the output maximum and minimum speed.
0x6048	vl velocity acceleration	Set and display the acceleration time.
0x6049	vl velocity deceleration	Set and display the deceleration time.
0x604C	vl dimension factor	Converts the [rpm] unit to the required unit.

NOTE: The objects 0x6043 and 0x6044 have the same value in the P1-ECT.

The inverter statuses are controlled by the object 0x6040 (Controlword) and displayed by the object 0x6041 (Statusword).

For information about other objects please refer to the chapter 10 “about the object dictionary” .

9.6.1 0x6042 vl target velocity

This sets the output speed of the inverter. The speed is given in revolutions per minute [rpm]. In case it any other unit is required, use the object 0x604C.

9.6.2 0x6043 vl velocity demand

This object displays the current speed of the inverter. The speed is given in [rpm]. In case it any other unit is required, use the object 0x604C. In the P1-ECT, this object has the same value as the object 0x6044.

9.6.3 0x6044 vl velocity actual value

This object displays the current speed of the inverter. The speed is given in [rpm]. In case it any other unit is required, use the object 0x604C. In the P1-ECT, this object has the same value as the object 0x6043.

9.6.4 0x6046 vl velocity min max value

This object can set and display the inverter minimum and maximum output speed. The speed is given in [rpm]. In case it any other unit is required, use the object 0x604C.

9.6.5 0x6048 vl velocity acceleration

This object can set and display the acceleration time.

9.6.6 0x6049 vl velocity deceleration

This object can set and display the deceleration time.

9.6.7 0x604C vl dimension factor

In the velocity mode, this object can be used for object for changing the other objects unit from [rpm] to any required unit



How can I control the frequency [Hz], instead of the speed [rpm]?



It can be done by using the object 0x604C
Please configure the following 2 subindexes of this object.
Subindex 0x01 (numerator) = 120
Subindex 0x02 (denominator) = number of poles of the motor

9.7 Application Example

This example uses the following settings.

[bA102] = 60.00[Hz]

Poles = 4

The whole object dictionary on default settings

[RxPDO]

- ① Introduce the 0x0006 value in the object 0x6040 Controlword.
- ② Introduce the 0x000F value in the object 0x6040 Controlword.
- ③ Set the object 0x6042 vl velocity demand to 1800[rpm].
- ④ Set the object 0x6042 vl velocity demand to 600[rpm].
- ⑤ Set the object 0x6042 vl velocity demand to 0[rpm].
- ⑥ Set the object 0x6042 vl velocity demand to -1800[rpm].
- ⑦ Set the object 0x6042 vl velocity demand to 0[rpm].

[TxPDO]

- ⑧ The CiA402 status changed to Ready to switch on. In this state the inverter is stopped.
- ⑨ The CiA402 status changed to Operation enabled. The run command with a speed command of 0[rpm] is entered. Consequently, a minimum speed limitation occurs.
- ⑩ It is accelerating in the forward direction. The “XXXX” shows the speed during the acceleration.
- ⑪ It is in a constant speed state. It has reached the speed of 1800[rpm] (60.00[Hz]).
- ⑫ It is decelerating. The “XXXX” shows the speed during the deceleration.
- ⑬ It is in a constant speed state. It has reached the speed of 600[rpm] (20.00[Hz]).
- ⑭ It is decelerating. The “XXXX” shows the speed during the deceleration.
- ⑮ The run command with a speed command of 0[rpm] is entered. Consequently, a minimum speed limitation occurs.
- ⑯ It is accelerating in the reverse direction. The “XXXX” shows the speed during the acceleration.
- ⑰ It is in a constant speed state. It has reached the speed of 1800[rpm] (60.00[Hz]).
- ⑱ It is decelerating. The “XXXX” shows the speed during the deceleration.
- ⑲ The run command with a speed command of 0[rpm] is entered. Consequently, a minimum speed limitation occurs.

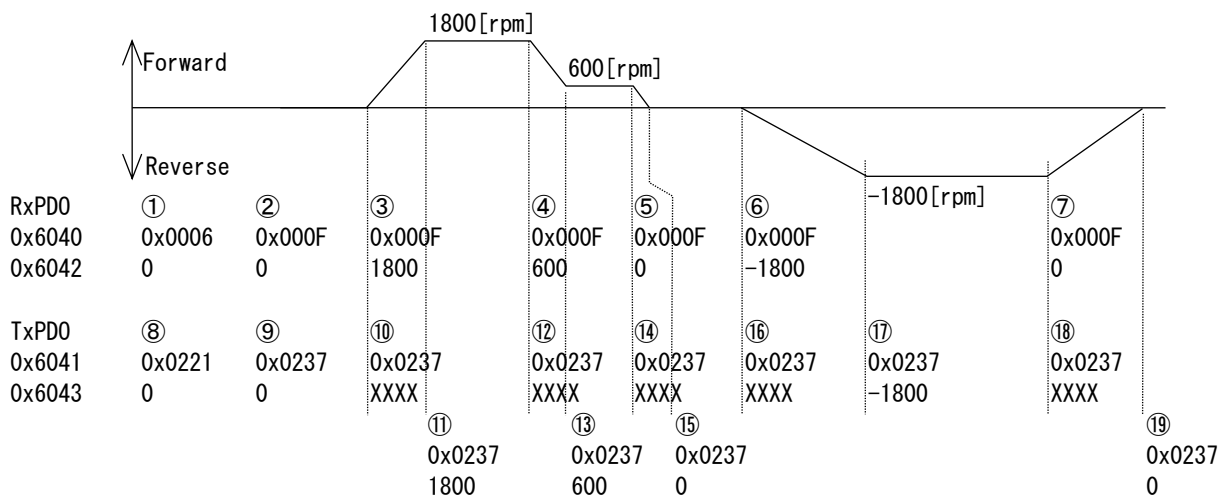

(Memo)

10

Chapter 10 Object Dictionary

Contents

10.1 About this chapter.....	10-1
10.2 Object Dictionary.....	10-2
10.2.1 Object Dictionary area.....	10-2
10.2.2 Data types.....	10-2
10.2.3 Access	10-3
10.2.4 PDO mapping.....	10-3
10.3 CoE communication area.....	10-4
10.4 Manufacturer specific area (Inverter parameter area).....	10-20
10.5 Device profile area.....	10-22

10.1 About this chapter

This chapter contains information about the CoE object dictionary.

10.2 Object Dictionary

10.2.1 Object Dictionary area

All objects are assigned a four-digit hexadecimal index in the areas shown in the following table.

Additionally, some objects are assigned two-digit hexadecimal sub-indexes.

In this guide the object index and sub-index are represented as 0xXXXX:0xXX (Index:Sub-index).

■ Object Dictionary area

Index	Area	Description
0x0000 - 0x0FFF	Data type area	Definition of data types
0x1000 - 0x1FFF	CoE communication area	CoE related variables
0x2000 - 0x5FFF	Manufacture specific area (inverter parameter area)	These are variables used to access the SJ-P1 inverter parameters.
0x6000 - 0xFFFF	Device profile area	These are variables defined in the CiA402 drive profile of the velocity mode

10.2.2 Data types

The P1-ECT use the data types described in the following table.

■ Data type

Data type	Code	Size	Range
Boolean	BOOL	1 Bit	0 ~ 1
Byte	BYTE	1 Byte	0 ~ 255
Unsigned8	USINT	1 Byte	0 ~ 255
Unsigned16	UINT	2 Bytes	0 ~ 65, 535
Unsigned32	UDINT	4 Bytes	0 ~ 4, 294, 967, 295
Integer8	SINT	1 Byte	-128 ~ 127
Integer16	INT	2 Bytes	-32, 768 ~ 32, 767
Integer32	DINT	4 Bytes	-2, 147, 483, 648 ~ 2, 147, 483, 647
Visible string	VS	—	—
Array	ARRAY	—	—

10.2.3 Access

The P1-ECT uses the access methods described in the following table.

■ Access

Access	Description
R	Read only object
W	Write only object
RW	Read-write object

10.2.4 PDO mapping

The P1-ECT uses the mapping methods described in the following table.

■ PDO mapping method

Access	Description
Possible	The object can be PDO mapped in both TxPDO and RxPDO.
Possible (TxPDO only)	The object can be PDO mapped only in TxPDO.
Not possible	The object cannot be PDO mapped in neither TxPDO or RxPDO.

10.3 CoE communication area

■ 0x1000

Sub-index	Item	Description
-	Name	Device type
	Data type	UDINT
	Access	R
	PDO mapping	Not possible
	Default settings	0x00010192
	Details	Bit 0 to 15: device profile number Bit 16 to 23: type (inverter is 0x01) Bit 24 to 31: mode (manufacturer specific)

■ 0x1001

Sub-index	Item	Description
-	Name	Error register
	Data type	USINT
	Access	R
	PDO mapping	Not possible
	Default settings	0
	Description	Bit 0: generic error Bit 1: current error Bit 2: voltage error Bit 3: temperature error Bit 4: communication error Bit 5: device profile specific error

■ 0x1008

Sub-index	Item	Description
-	Name	Manufacturer device name
	Data type	VS (6 bytes)
	Access	R
	PDO mapping	Not possible
	Default settings	P1-ECT
	Description	Contains the device model.

■ 0x1009

Sub-index	Item	Description
-	Name	Manufacturer hardware version
	Data type	VS (4 bytes)
	Access	R
	PDO mapping	Not possible
	Default settings	1.00
	Description	Contains a number like "x.xx" that indicates the hardware version.

■ 0x100A

Sub-index	Item	Description
-	Name	Manufacturer software version
	Data type	VS (4bytes)
	Access	R
	PDO mapping	Not possible
	Default settings	5.11
	Details	Contains a number like "x.xx" that indicates the EtherCAT slave stack code version.

■ 0x1010

Sub-index	Item	Description
-	Name	Store parameters
	Details	Used for storing the parameters into the flash memory. In order to store the parameters write "0x65766173" (means "save" in ASCII code. The least significant byte is the "s") on the appropriate subindex. When reading the sub-indexes 0x01 to 0x04 it will return the following data: Bit 0 = 0: save command is not supported. = 1: save command is supported. Bit 1: 0 = auto save is not supported. Bit 2 to 31: Reserved (0x0000).
0x00	Name	Highest sub-index supported
	Data type	USINT
	Access	R
	PDO mapping	Not possible
	Default settings	4
	Details	Contains the number of sub-indexes of this object.
0x01	Name	Save all parameters
	Data type	UDINT
	Access	RW
	PDO mapping	Not possible
	Default settings	0x00000001
	Details	The following objects are stored in the P1-ECT flash memory 0x1001, 0x10F3, 0x6007, 0x604C:0x01, 0x604C:0x02, 0x605A, 0x605B, 0x605C, 0x605E
0x02	Name	Save communication parameters
	Data type	UDINT
	Access	R
	PDO mapping	Not possible
	Default settings	0x00000000
	Details	Saving in this object is not supported.

0x03	Name	Save application parameters
	Data type	UDINT
	Access	R
	PDO mapping	Not possible
	Default settings	0x00000000
	Details	Saving in this object is not supported.
0x04	Name	Save inverter parameters
	Data type	UDINT
	Access	RW
	PDO mapping	Not possible
	Default settings	0x00000001
	Details	Store the inverter parameters into the inverter flash memory. This is the same as writing in the flash memory by using the SJ-P1 Modbus register number 9000.

■ 0x1011

Sub-index	Item	Description
-	Name	Restore default parameters
	Details	Reset the parameter setting and its flash memory settings to the default settings. In order to reset the parameters write "0x64616F6C" (means "load" in ASCII code. The least significant byte is the "l") on the appropriate subindex. When reading the sub-indexes 0x01 to 0x04 it will return the following data: Bit 0 = 0: reset command is not supported. = 1: reset command is supported. Bit 1 to 31: Reserved (0x0000).
0x00	Name	Highest sub-index supported
	Data type	USINT
	Access	R
	PDO mapping	Not possible
	Default settings	4
	Details	Contains the number of sub-indexes of this object.
0x01	Name	Restore all default parameters
	Data type	UDINT
	Access	RW
	PDO mapping	Not possible
	Default settings	0x00000001
	Details	The following objects are reset. 0x1001, 0x10F3, 0x6007, 0x604C:0x01, 0x604C:0x02, 0x605A, 0x605B, 0x605C, 0x605E

0x02	Name	Restore communication default parameters
	Data type	UDINT
	Access	R
	PDO mapping	Not possible
	Default settings	0x00000000
	Details	Reset in this object is not supported
0x03	Name	Restore application default parameters
	Data type	UDINT
	Access	R
	PDO mapping	Not possible
	Default settings	0x00000000
	Details	Reset in this object is not supported
0x04	Name	Restore inverter parameters
	Data type	UDINT
	Access	RW
	PDO mapping	Not possible
	Default settings	0x00000001
	Details	Reset inverter parameters.

■ 0x1018

Sub-index	Item	Description
-	Name	Identity object
	Details	This object contains the device information.
0x00	Name	Highest sub-index supported
	Data type	USINT
	Access	R
	PDO mapping	Not possible
	Default settings	4
	Details	Contains the number of sub-indexes of this object.
0x01	Name	Vendor-ID
	Data type	UDINT
	Access	R
	PDO mapping	Not possible
	Default settings	0x0000051D
	Details	Contains the vendor-ID.
0x02	Name	Product code
	Data type	UDINT
	Access	R
	PDO mapping	Not possible
	Default settings	0x03010100
	Details	Contains the product code.
0x03	Name	Revision number
	Data type	UDINT
	Access	R
	PDO mapping	Not possible
	Default settings	Revision number
	Details	Contains the Revision number.

0x04	Name	Serial number
	Data type	UDINT
	Access	R
	PDO mapping	Not possible
	Default settings	0x00000000
	Details	Contains the serial number. The serial number of all P1-ECT is 0x00000000.

■ 0x10F3

Sub-index	Item	Description
-	Name	Diagnosis History
	Details	It displays the error history. The error history is stored from the sub-index 0x06 to the 0x0D. It stores the data as ring buffer. That is, after the 0x0D sub-index it will overwrite the 0x06 sub-index.
0x00	Name	Highest sub-index supported
	Data type	USINT
	Access	R
	PDO mapping	Not possible
	Default settings	5 (When the history is clear it will contain 5, after there have been some error entries it can increase until 13)
	Details	Contains the number of sub-indexes of this object.
0x01	Name	Maximum Messages
	Data type	USINT
	Access	R
	PDO mapping	Not possible
	Default settings	8
	Details	Contain the maximum number of error messages.
0x02	Name	Newest Message
	Data type	USINT
	Access	R
	PDO mapping	Not possible
	Default settings	0
	Details	Has the number of the Sub-Index where the latest diagnosis message is saved.
0x03	Name	Newest Acknowledged Message
	Data type	USINT
	Access	RW
	PDO mapping	Not possible
	Default settings	0
	Details	It will do the following actions when this object gets written. 0 : Clear the diagnosis history. This value does not change. 1 ~ 5, 14 ~ 255 : will return an SDO abort code (0x06090030) 6 ~ 13 : Write the value without checking. When the message queue will be overwritten, this sub-index value will return to 0.
0x04	Name	New Messages Available
	Data type	USINT
	Access	R
	PDO mapping	Possible (TxPDO only)
	Default settings	0
	Details	0: all the diagnosis history was read. 1: not all the diagnosis history was read

0x05	Name	Flags
	Data type	UINT
	Access	RW
	PDO mapping	Not possible
	Default settings	1
	Details	<p>Flags to control the sending or storing of diagnosis messages</p> <p>Bit 0 : Sets whether to send or not the diagnosis message as an emergency message. = 0 : Emergency message is disabled. = 1 : Emergency message is enable.</p> <p>Bit 1 = 0 : info messages enabled = 1 : info messages disabled</p> <p>Bit 2 = 0 : warning messages enabled = 1 : warning messages disabled</p> <p>Bit 3 = 0 : error messages enabled = 1 : error messages disabled</p> <p>Bit 4 = 0 : Overwrite mode</p> <p>Bit 5 = 1 : unacknowledged messages have been overwritten</p> <p>Bit 6-15 : reserved (0)</p>
0x06	Name	Diagnosis message 1
	Data type	Array of [0 to 15] Bytes
	Access	R
	PDO mapping	Not possible
	Default settings	0
	Details	<p>Diagnosis history 1.</p> <p>Bytes 0 to 3 = Error Code</p> <p>Lower 2 bytes : 0xE800 Fixed</p> <p>Upper 2 bytes : Emergency message error code.</p> <p>Bytes 4 and 5 = Flag. Error type. = 1 : Warning = 2 : Error</p> <p>Byte 6-15 = Reserved.</p>
0x07	Name	Diagnosis message 2
	Data type	Array of [0 to 15] Bytes
	Access	R
	PDO mapping	Not possible
	Default settings	0
	Details	Diagnosis history 2. same behavior as Diagnosis history 1.
0x08	Name	Diagnosis message 3
	Data type	Array of [0 to 15] Bytes
	Access	R
	PDO mapping	Not possible
	Default settings	0
	Details	Diagnosis history 3. same behavior as Diagnosis history 1.
0x09	Name	Diagnosis message 4
	Data type	Array of [0 to 15] Bytes
	Access	R
	PDO mapping	Not possible
	Default settings	0
	Details	Diagnosis history 4. same behavior as Diagnosis history 1.
0x0A	Name	Diagnosis message 5
	Data type	Array of [0 to 15] Bytes
	Access	R
	PDO mapping	Not possible
	Default settings	0
	Details	Diagnosis history 5. same behavior as Diagnosis history 1.

0x0B	Name	Diagnosis message 6
	Data type	Array of [0 to 15] Bytes
	Access	R
	PDO mapping	Not possible
	Default settings	0
	Details	Diagnosis history 6.same behavior as Diagnosis history 1.
0x0C	Name	Diagnosis message 7
	Data type	Array of [0 to 15] Bytes
	Access	R
	PDO mapping	Not possible
	Default settings	0
	Details	Diagnosis history 7.same behavior as Diagnosis history 1.
0x0D	Name	Diagnosis message 8
	Data type	Array of [0 to 15] Bytes
	Access	R
	PDO mapping	Not possible
	Default settings	0
	Details	Diagnosis history 8.same behavior as Diagnosis history 1.

■ 0x1600

Sub-index	Item	Description
-	Name	RPDO mapping parameter
	Details	Implement the RxPDO mapping. Bits 0 to 7 : Bit size of the object Bits 8 to 15 : Sub-Index Bits 16 to 31 : Index
0x00	Name	Number of objects in this PDO
	Data type	USINT
	Access	RW (writing is enabled only in the “Pre-Operational” state)
	PDO mapping	Not possible
	Default settings	0
	Details	Set the number of objects to be mapped for the RxPDO (10 max).
0x01	Name	Output Object to be mapped 1
	Data type	UDINT
	Access	RW (writing is enabled only in the “Pre-Operational” state)
	PDO mapping	Not possible
	Default settings	0x00000000
	Details	Specify the object for RxPDO.
0x02	Name	Output Object to be mapped 2
	Data type	UDINT
	Access	RW (writing is enabled only in the “Pre-Operational” state)
	PDO mapping	Not possible
	Default settings	0x00000000
	Details	Specify the object for RxPDO.
0x03	Name	Output Object to be mapped 3
	Data type	UDINT
	Access	RW (writing is enabled only in the “Pre-Operational” state)
	PDO mapping	Not possible
	Default settings	0x00000000
	Details	Specify the object for RxPDO.

0x04	Name	Output Object to be mapped 4
	Data type	UDINT
	Access	RW (writing is enabled only in the “Pre-Operational” state)
	PDO mapping	Not possible
	Default settings	0x00000000
	Details	Specify the object for RxPDO.
0x05	Name	Output Object to be mapped 5
	Data type	UDINT
	Access	RW (writing is enabled only in the “Pre-Operational” state)
	PDO mapping	Not possible
	Default settings	0x00000000
	Details	Specify the object for RxPDO.
0x06	Name	Output Object to be mapped 6
	Data type	UDINT
	Access	RW
	PDO mapping	Not possible
	Default settings	0x00000000
	Details	Specify the object for RxPDO.
0x07	Name	Output Object to be mapped 7
	Data type	UDINT
	Access	RW
	PDO mapping	Not possible
	Default settings	0x00000000
	Details	Specify the object for RxPDO.
0x08	Name	Output Object to be mapped 8
	Data type	UDINT
	Access	RW
	PDO mapping	Not possible
	Default settings	0x00000000
	Details	Specify the object for RxPDO.
0x09	Name	Output Object to be mapped 9
	Data type	UDINT
	Access	RW
	PDO mapping	Not possible
	Default settings	0x00000000
	Details	Specify the object for RxPDO.
0x0A	Name	Output Object to be mapped 10
	Data type	UDINT
	Access	RW
	PDO mapping	Not possible
	Default settings	0x00000000
	Details	Specify the object for RxPDO.

■ 0x1605

Sub-index	Item	Description
-	Name	RPDO mapping parameter
	Details	Implement the static RxPDO mapping. Bits 0 to 7 : Bit size of the object Bits 8 to 15 : Sub-Index Bits 16 to 31 : Index

0x00	Name	Number of objects in this PDO
	Data type	USINT
	Access	R
	PDO mapping	Not possible
	Default settings	2
	Details	Indicates the number of objects to be mapped. (this configuration cannot be changed)
0x01	Name	Output Object to be mapped 1
	Data type	UDINT
	Access	R
	PDO mapping	Not possible
	Default settings	0x60400010
	Details	Allocate the object 6040h for the RxPDO. (this configuration cannot be changed)
0x02	Name	Output Object to be mapped 2
	Data type	UDINT
	Access	R
	PDO mapping	Not possible
	Default settings	0x60420010
	Details	Allocate the object 6042h for the RxPDO. (this configuration cannot be changed)

■ 0x1A00

Sub-index	Item	Description
-	Name	TPDO mapping
	Details	Implement the TxPDO mapping. Bits 0 to 7 : Bit size of the object Bits 8 to 15 : Sub-Index Bits 16 to 31 : Index
0x00	Name	Number of objects in this PDO
	Data type	USINT
	Access	RW (writing is enabled only in the "Pre-Operational" state)
	PDO mapping	Not possible
	Default settings	0
	Details	Set the number of objects to be mapped for the TxPDO (10 max).
0x01	Name	Output Object to be mapped 1
	Data type	UDINT
	Access	RW (writing is enabled only in the "Pre-Operational" state)
	PDO mapping	Not possible
	Default settings	0x00000000
	Details	Specify the object for TxPDO.
0x02	Name	Output Object to be mapped 2
	Data type	UDINT
	Access	RW (writing is enabled only in the "Pre-Operational" state)
	PDO mapping	Not possible
	Default settings	0x00000000
	Details	Specify the object for TxPDO.
0x03	Name	Output Object to be mapped 3
	Data type	UDINT
	Access	RW (writing is enabled only in the "Pre-Operational" state)
	PDO mapping	Not possible
	Default settings	0x00000000
	Details	Specify the object for TxPDO.

0x04	Name	Output Object to be mapped 4
	Data type	UDINT
	Access	RW (writing is enabled only in the “Pre-Operational” state)
	PDO mapping	Not possible
	Default settings	0x00000000
	Details	Specify the object for TxPDO.
0x05	Name	Output Object to be mapped 5
	Data type	UDINT
	Access	RW (writing is enabled only in the “Pre-Operational” state)
	PDO mapping	Not possible
	Default settings	0x00000000
	Details	Specify the object for TxPDO.
0x06	Name	Output Object to be mapped 6
	Data type	UDINT
	Access	RW (writing is enabled only in the “Pre-Operational” state)
	PDO mapping	Not possible
	Default settings	0x00000000
	Details	Specify the object for TxPDO.
0x07	Name	Output Object to be mapped 7
	Data type	UDINT
	Access	RW (writing is enabled only in the “Pre-Operational” state)
	PDO mapping	Not possible
	Default settings	0x00000000
	Details	Specify the object for TxPDO.
0x08	Name	Output Object to be mapped 8
	Data type	UDINT
	Access	RW (writing is enabled only in the “Pre-Operational” state)
	PDO mapping	Not possible
	Default settings	0x00000000
	Details	Specify the object for TxPDO.
0x09	Name	Output Object to be mapped 9
	Data type	UDINT
	Access	RW (writing is enabled only in the “Pre-Operational” state)
	PDO mapping	Not possible
	Default settings	0x00000000
	Details	Specify the object for TxPDO.
0x0A	Name	Output Object to be mapped 10
	Data type	UDINT
	Access	RW (writing is enabled only in the “Pre-Operational” state)
	PDO mapping	Not possible
	Default settings	0x00000000
	Details	Specify the object for TxPDO.

■ 0x1A05

Sub-index	Item	Description
-	Name	TPDO mapping
	Details	Implement the static TxPDO mapping. Bits 0 to 7 : Bit size of the object Bits 8 to 15 : Sub-Index Bits 16 to 31 : Index

0x00	Name	Number of objects in this PDO
	Data type	USINT
	Access	R
	PDO mapping	Not possible
	Default settings	2
	Details	Indicates the number of objects to be mapped. (this configuration cannot be changed)
0x01	Name	Output Object to be mapped 1
	Data type	UDINT
	Access	R
	PDO mapping	Not possible
	Default settings	0x60410010
	Details	Allocate the object 6041h for the TxPDO. (this configuration cannot be changed)
0x02	Name	Output Object to be mapped 2
	Data type	UDINT
	Access	R
	PDO mapping	Not possible
	Default settings	0x60430010
	Details	Allocate the object 6043h for the RxPDO. (this configuration cannot be changed)

■ 0x1C00

Sub-index	Item	Description
-	Name	Sync Manager Communication Type
	Details	Determines the Sync manager type of communication. The possible settings and their definition are shown below. 0 : unused 1 : mailbox receive (master to slave) 2 : mailbox send(slave to master) 3 : process data output(master to slave) 4 : process data input (slave to master)
0x00	Name	Number of used Sync Manager channels
	Data type	USINT
	Access	R
	PDO mapping	Not possible
	Default settings	4
	Details	Indicates the number of used Sync manager channels.
0x01	Name	Communication Type Sync Manager 0
	Data type	USINT
	Access	R
	PDO mapping	Not possible
	Default settings	1
	Details	Communication type of the sync manager 0 The sync manager 0 is configured as mailbox receive (master to slave).
0x02	Name	Communication Type Sync Manager 1
	Data type	USINT
	Access	R
	PDO mapping	Not possible
	Default settings	2
	Details	Communication type of the sync manager 1 The sync manager 1 is configured as mailbox send (slave to master).

0x03	Name	Communication Type Sync Manager 2
	Data type	USINT
	Access	R
	PDO mapping	Not possible
	Default settings	3
	Details	Communication type of the sync manager 2 The sync manager 2 is configured as process data output (master to slave).
0x04	Name	Communication Type Sync Manager 3
	Data type	USINT
	Access	R
	PDO mapping	Not possible
	Default settings	4
	Details	Communication type of the sync manager 3 The sync manager 3 is configured as process data input (slave to master)

■ 0x1C12

Sub-index	Item	Description
-	Name	Sync Manager 2 PDO Assignment
	Details	PDO Assignment setting for the Sync manager 2.
0x00	Name	Number of assigned TxPDOs
	Data type	USINT
	Access	RW (writing is enabled only in the "Pre-Operational" state)
	PDO mapping	Not possible
	Default settings	1
	Details	Set the number of PDOs used by the Sync Manager 2. (2 max)
0x01	Name	PDO mapping object index of assigned PDO
	Data type	UINT
	Access	RW (writing is enabled only in the "Pre-Operational" state)
	PDO mapping	Not possible
	Default settings	0x1605
	Details	Set the PDO used by the Sync Manager 2.
0x02	Name	PDO mapping object index of assigned PDO
	Data type	UINT
	Access	RW (writing is enabled only in the "Pre-Operational" state)
	PDO mapping	Not possible
	Default settings	0
	Details	Set the PDO used by the Sync Manager 2.

■ 0x1C13

Sub-index	Item	Description
-	Name	Sync Manager 3 PDO Assignment
	Details	PDO Assignment setting for the Sync manager 3.
0x00	Name	Number of assigned TxPDOs
	Data type	USINT
	Access	RW (writing is enabled only in the "Pre-Operational" state)
	PDO mapping	Not possible
	Default settings	1
	Details	Set the number of PDOs used by the Sync Manager 3. (2 max)

0x01	Name	PDO mapping object index of assigned PDO
	Data type	UINT
	Access	RW (writing is enabled only in the “Pre-Operational” state)
	PDO mapping	Not possible
	Default settings	0x1A05
	Details	Set the PDO used by the Sync Manager 3.
0x02	Name	PDO mapping object index of assigned PDO
	Data type	UINT
	Access	RW (writing is enabled only in the “Pre-Operational” state)
	PDO mapping	Not possible
	Default settings	0
	Details	Set the PDO used by the Sync Manager 3.

■ 0x1C32

Sub-index	Item	Description
-	Name	Sync Manager Synchronization
	Details	Indicates the synchronization settings of the Sync manager 2
0x00	Name	Number of Synchronization Parameters
	Data type	USINT
	Access	R
	PDO mapping	Not possible
	Default settings	0x20
	Details	Indicates the number of sub-indexes of this object.
0x01	Name	Synchronization type
	Data type	UINT
	Access	R
	PDO mapping	Not possible
	Default settings	0x0000
	Details	Indicates the synchronization settings of the Sync manager 2 0 : Free Run Mode
0x02	Name	Cycle time
	Data type	UDINT
	Access	R
	PDO mapping	Not possible
	Default settings	0x00000000
	Details	Indicates the Sync manager 2 cycle time in [ns]. Since the Synchronization type is configured as Free Run Mode this sub-index will be fixed with the value 0.
0x04	Name	Synchronization Types supported
	Data type	UINT
	Access	R
	PDO mapping	Not possible
	Default settings	0x0001
	Details	Indicates the synchronization types supported by the Sync manager 2.
0x05	Name	Minimum Cycle Time
	Data type	UDINT
	Access	R
	PDO mapping	Not possible
	Default settings	1000
	Details	Indicates the minimum cycle time of the Sync manager 2 in [ns]. Since internally it operates at approximately 1000[ns], this sub-index is configured as 1000[ns].

0x06	Name	Calc and Copy Time
	Data type	UDINT
	Access	R
	PDO mapping	Not possible
	Default settings	0x00000000
	Details	Since the Free Run Mode is being used, this is sub-index will not be used.
0x08	Name	Minimum Delay Time
	Data type	UINT
	Access	RW
	PDO mapping	Not possible
	Default settings	0x0000
	Details	Since the Free Run Mode is being used, this is sub-index will not be used.
0x09	Name	Get Cycle Time
	Data type	UDINT
	Access	R
	PDO mapping	Not possible
	Default settings	0x00000000
	Details	Since the Free Run Mode is being used, this is sub-index will not be used.
0x0A	Name	Delay Time
	Data type	UDINT
	Access	RW
	PDO mapping	Not possible
	Default settings	0x00000000
	Details	Since the Free Run Mode is being used, this is sub-index will not be used.
0x0B	Name	Sync0 Cycle Time
	Data type	UINT
	Access	RW
	PDO mapping	Not possible
	Default settings	0x0000
	Details	Since the Free Run Mode is being used, this is sub-index will not be used.
0x0C	Name	SM Event Missed
	Data type	UINT
	Access	R
	PDO mapping	Not possible
	Default settings	0x0000
	Details	Since the Free Run Mode is being used, this is sub-index will not be used.
0x20	Name	Sync Error
	Data type	BOOL
	Access	R
	PDO mapping	Not possible
	Default settings	0x0
	Details	Since the Free Run Mode is being used, this is sub-index will not be used.

■ 0x1C33

Sub-index	Item	Description
-	Name	Sync Manager Synchronization
	Details	Indicates the synchronization settings of the Sync manager 3
0x00	Name	Number of Synchronization Parameters
	Data type	USINT
	Access	R
	PDO mapping	Not possible
	Default settings	0x20
	Details	Indicates the number of sub-indexes of this object.
0x01	Name	Synchronization type
	Data type	UINT
	Access	R
	PDO mapping	Not possible
	Details	Indicates the synchronization settings of the Sync manager 3 0 : Free Run Mode
0x02	Name	Cycle time
	Data type	UDINT
	Access	R
	PDO mapping	Not possible
	Details	Indicates the Sync manager 2 cycle time in [ns]. Since the Synchronization type is configured as Free Run Mode this sub-index will be fixed with the value 0.
0x04	Name	Synchronization Types supported
	Data type	UINT
	Access	R
	PDO mapping	Not possible
	Details	Indicates the synchronization types supported by the Sync manager 3.
0x05	Name	Minimum Cycle Time
	Data type	UDINT
	Access	R
	PDO mapping	Not possible
	Details	Indicates the minimum cycle time of the Sync manager 3 in [ns]. Since internally it operates at approximately 1000[ns], this sub-index is configured as 1000[ns].
0x06	Name	Calc and Copy Time
	Data type	UDINT
	Access	R
	PDO mapping	Not possible
	Details	Since the Free Run Mode is being used, this is sub-index will not be used.
0x08	Name	Minimum Delay Time
	Data type	UINT
	Access	RW
	PDO mapping	Not possible
	Details	Since the Free Run Mode is being used, this is sub-index will not be used.

0x09	Name	Get Cycle Time
	Data type	UDINT
	Access	R
	PDO mapping	Not possible
	Default settings	0x00000000
	Details	Since the Free Run Mode is being used, this is sub-index will not be used.
0x0A	Name	Delay Time
	Data type	UDINT
	Access	RW
	PDO mapping	Not possible
	Default settings	0x00000000
	Details	Since the Free Run Mode is being used, this is sub-index will not be used.
0x0B	Name	Sync0 Cycle Time
	Data type	UINT
	Access	RW
	PDO mapping	Not possible
	Default settings	0x0000
	Details	Since the Free Run Mode is being used, this is sub-index will not be used.
0x0C	Name	SM Event Missed
	Data type	UINT
	Access	R
	PDO mapping	Not possible
	Default settings	0x0000
	Details	Since the Free Run Mode is being used, this is sub-index will not be used.
0x20	Name	Sync Error
	Data type	BOOL
	Access	R
	PDO mapping	Not possible
	Default settings	0x0
	Details	Since the Free Run Mode is being used, this is sub-index will not be used.

10.4 Manufacturer specific area (Inverter parameter area)

The inverter parameters are designated the objects 0x3003 to 0x3063 and 0x4003 to 0x4063. The objects 0x3003 to 0x3063 are 2-bytes parameters while the objects 0x4003 to 0x4063 are 4-bytes parameters.

The index and sub-index are calculated from the P1 Modbus register number. The calculation method is explained below.

$$\begin{aligned} \text{Index :} & \quad 0x3000 + (\text{Modbus Register number} / 254) \\ & \quad 0x4000 + (\text{Modbus Register number} / 254) \\ \text{Sub-Index :} & \quad 1 + (\text{Modbus Register number} \% 254) \end{aligned}$$

「Modbus Register number / 254」 is the integer part after the Modbus register number is divided by 254.

「Modbus Register number % 254」 is the residue after the inverter register number is divided by 254.

For information about the supported objects please refer to the Chapter 13 “Parameter List”

■ 0x3003 ~ 0x3063

Sub-index	Item	Description
-	Name	Inverter parameter object
	Details	2-byte inverter parameter
0x00	Name	Highest sub-index supported
	Data type	USINT
	Access	R
	PDO mapping	Not possible
	Default settings	Depends on the object
	Details	Indicates the number of sub-indexes of this object.
0x01	Name	Inverter parameter
	Data type	UINT or INT
	Access	RW or R
	PDO mapping	Depends on the object
	Default settings	Depends on the object

·
·
·

0xFE	Name	Inverter parameter
	Data type	UINT or INT
	Access	RW or R
	PDO mapping	Depends on the object
	Default settings	Depends on the object

■ 0x4003 ~ 0x4063

Sub-index	Item	Description
-	Name	Inverter parameter object
	Details	4-byte inverter parameter
0x00	Name	Highest sub-index supported
	Data type	USINT
	Access	R
	PDO mapping	Not possible
	Default settings	Depends on the object
	Details	Indicates the number of sub-indexes of this object.
0x01	Name	Inverter parameter
	Data type	UDINT or DINT
	Access	RW or R
	PDO mapping	Depends on the object
	Default settings	Depends on the object
	.	.
0xFE	Name	Inverter parameter
	Data type	UDINT or DINT
	Access	RW or R
	PDO mapping	Depends on the object
	Default settings	Depends on the object

10.5 Device profile area

0x6007

Sub-index	Item	Description
-	Name	Abort connection option code
	Data type	INT
	Access	RW
	PDO mapping	Not possible
	Default settings	1
	Details	Set the action to be executed in case of an EtherCAT communication failure. 【Setting value】 0 : No action 1 : Fault signal (follow the 0x605E object setting) 2 : Disable voltage command 3 : Quick stop command

0x603F

Sub-index	Item	Description
-	Name	Error code
	Data type	UINT
	Access	R
	PDO mapping	Possible (TxPDO only)
	Default settings	0
	Details	Indicate the latest error code that occurred in the unit. The error code is the same as in the emergency message.

0x6040

Sub-index	Item	Description
-	Name	Controlword
	Data type	UINT
	Access	RW
	PDO mapping	Possible
	Default settings	0
	Details	Object for controlling the inverter communication status. For more information refer to the section 9.3 "0x6040 Control word"

0x6041

Sub-index	Item	Description
-	Name	Statusword
	Data type	UINT
	Access	R
	PDO mapping	Possible (TxPDO only)
	Default settings	0
	Details	Indicates the inverter communication status. For more information refer to the section 9.4 "0x6040 Status word"

■ 0x6042

Sub-index	Item	Description
-	Name	vI target velocity
	Data type	INT
	Access	RW
	PDO mapping	Possible
	Default settings	0
	Details	Sets the output speed of the inverter. If the object 0x604C value is 1 this object will be expressed in [rpm]. In case it any other unit is required, use the object 0x604C.

■ 0x6043

Sub-index	Item	Description
-	Name	vI velocity demand
	Data type	INT
	Access	R
	PDO mapping	Possible (TxPDO only)
	Default settings	0
	Details	Displays the current speed of the inverter. If the object 0x604C value is 1 this object will be expressed in [rpm]. In case it any other unit is required, adjust the value of the object 0x604C. This object is related with the parameter dA-12.

■ 0x6044

Sub-index	Item	Description
-	Name	vI velocity actual value
	Data type	INT
	Access	R
	PDO mapping	Possible (TxPDO only)
	Default settings	0
	Details	Displays the current speed of the inverter. If the object 0x604C value is 1 this object will be expressed in [rpm]. In case it any other unit is required, adjust the value of the object 0x604C. This object is related with the parameter dA-12. In the P1-ECT, this object has the same value as the object 0x6043.

■ 0x6046

Sub-index	Item	Description
-	Name	vI velocity min max amount
	Details	Set and display the inverter minimum and maximum output speed.
0x00	Name	Highest sub-index supported
	Data type	USINT
	Access	R
	PDO mapping	Not possible
	Default settings	2
	Details	Indicates the number of sub-indexes of this object.

0x01	Name	vl velocity min amount
	Data type	UDINT
	Access	RW
	PDO mapping	Possible
	Default settings	0
	Details	Sets the minimum speed. If the object 0x604C value is 1 this object will be expressed in [rpm]. In case it any other unit is required, adjust the value of the object 0x604C. This sub-index is related with the parameter bA103.
0x02	Name	vl velocity max amount
	Data type	UDINT
	Access	RW
	PDO mapping	Possible
	Default settings	0x00000708
	Details	Sets the maximum speed. If the object 0x604C value is 1 this object will be expressed in [rpm]. In case it any other unit is required, adjust the value of the object 0x604C. This sub-index is related with the parameter bA102.

■ 0x6048

Sub-index	Item	Description
-	Name	vl velocity acceleration
	Details	Set the inverter acceleration time. The acceleration time is the time that the inverter takes to go from 0[Hz] to the maximum frequency.
0x00	Name	Highest sub-index supported
	Data type	USINT
	Access	R
	PDO mapping	Not possible
	Default settings	2
	Details	Indicates the number of sub-indexes of this object.
0x01	Name	Delta speed
	Data type	UDINT
	Access	R
	PDO mapping	Possible (TxPDO only)
	Default settings	0x00000708
	Details	Displays the maximum speed. If the object 0x604C value is 1 this object will be expressed in [rpm]. In case it any other unit is required, adjust the value of the object 0x604C. This sub-index has the same value as the object 0x6049:0x01.
0x02	Name	Delta time
	Data type	UINT
	Access	RW
	PDO mapping	Possible
	Default settings	0x001E
	Details	Sets the inverter acceleration time. The time is given in [s]. This sub-index is related to the parameter FA-10

■ 0x6049

Sub-index	Item	Description
-	Name	v1 velocity deceleration
	Details	Set the inverter deceleration time. The deceleration time is the time that the inverter takes to go from 0[Hz] to the maximum frequency.
0x00	Name	Highest sub-index supported
	Data type	USINT
	Access	R
	PDO mapping	Not possible
	Default settings	2
	Details	Indicates the number of sub-indexes of this object.
0x01	Name	Delta speed
	Data type	UDINT
	Access	R
	PDO mapping	Possible (TxPDO only)
	Default settings	0x00000708
	Details	Displays the maximum speed. If the object 0x604C value is 1 this object will be expressed in [rpm]. In case it any other unit is required, adjust the value of the object 0x604C. This sub-index has the same value as the object 0x6048:0x01.
0x02	Name	Delta time
	Data type	UINT
	Access	RW
	PDO mapping	Possible
	Default settings	0x001E
	Details	Sets the inverter deceleration time. The time is given in [s]. This sub-index is related to the parameter FA-12.

■ 0x604C

Sub-index	Item	Description
-	Name	v1 dimension factor
	Details	Converts the [rpm] unit to the required unit. This unit change will affect the following objects. 0x6042, 0x6043, 0x6044, 0x6046:0x01, 0x6046:0x02, 0x6048:0x01, 0x6049:0x01 For example, in case it is required to display the speed in [Hz]. By setting the objects, 0x604C:0x01 = 120 0x604C:0x02 = number of poles the objects related to the inverter speed can be displayed and configured in [Hz]
0x00	Name	Highest sub-index supported
	Data type	USINT
	Access	R
	PDO mapping	Not possible
	Default settings	2
	Details	Indicates the number of sub-indexes of this object.

0x01	Name	v1 dimension factor numerator
	Data type	DINT
	Access	RW
	PDO mapping	Possible
	Default settings	1
	Details	Sets the numerator of the unit conversion formula. The value range is from -3500 to 3500(0 not included).
0x02	Name	v1 dimension factor denominator
	Data type	DINT
	Access	RW
	PDO mapping	Possible
	Default settings	1
	Details	Sets the denominator of the unit conversion formula. The value range is from -3500 to 3500(0 not included).

■ 0x605A

Sub-index	Item	Description
-	Name	Quick stop option code
	Data type	INT
	Access	RW
	PDO mapping	Not possible
	Default settings	1
	Details	<p>Sets the action to be executed in case of receiving a Quick stop command</p> <p>【Setting value】</p> <p>0 : Free run stop and change to the switch on disabled state.</p> <p>1 : Decelerate until it stops, then change to the switch on disabled state.</p> <p>2 : Decelerate until stops, using the deceleration time of the parameter AC126 (two-stage accel/decel 1st deceleration time), then change to the switch on disabled state.</p> <p>5 : Stays in the Quick Stop Active state, and decelerate until it stops when the Disable voltage command is received.</p> <p>6 : Stays in the Quick Stop Active state, and decelerate until it stops using the deceleration time of the parameter AC126 when the Disable voltage command is received</p>

■ 0x605B

Sub-index	Item	Description
-	Name	Shutdown option code
	Data type	INT
	Access	RW
	PDO mapping	Not possible
	Default settings	0
	Details	<p>Sets the action to be executed in case a Shutdown command was received and it will change from the operation enabled state to the Ready to switch on state.</p> <p>【Setting value】</p> <p>0 : Free run stop</p> <p>1 : Decelerate until stops</p>

■ 0x605C

Sub-index	Item	Description
-	Name	Disable operation option code
	Data type	INT
	Access	RW
	PDO mapping	Not possible
	Default settings	1
	Details	Sets the action to be executed in case a Disable operation command was received and it will change from the operation enabled state to the Switched on state. 【Setting value】 0 : Free run stop 1 : Decelerate until stops

■ 0x605E

Sub-index	Item	Description
-	Name	Fault reaction option code
	Data type	INT
	Access	RW
	PDO mapping	Not possible
	Default settings	0
	Details	Sets the action to be executed in case of an EtherCAT communication failure and the object 0x6007 value setting is 1. 【Setting value】 0 : Free run stop 1 : Decelerate until stops 2 : Decelerate until stops, using the deceleration time of the parameter AC126.

■ 0x6060

Sub-index	Item	Description
-	Name	Modes of operation
	Data type	SINT
	Access	RW
	PDO mapping	Possible
	Default settings	2
	Details	Sets the operation mode 【Setting value】 2 : Velocity mode

■ 0x6061

Sub-index	Item	Description
-	Name	Modes of operation display
	Data type	SINT
	Access	R
	PDO mapping	Possible (TxPDO only)
	Default settings	2
	Details	Displays the current operation mode. 【Setting value】 2 : Velocity mode

■ 0x6502

Sub-index	Item	Description
-	Name	Supported drive modes
	Data type	UDINT
	Access	R
	PDO mapping	Possible (TxPDO only)
	Default settings	2
	Details	<p>Indicates the supported operation modes. If the operation mode is supported the bit will be ON, otherwise it will be OFF. Since the P1-ECT only supports the velocity mode, only the bit1 will be ON</p> <p>【Bit Description】</p> <p>bit0 : pp bit1 : vl bit2 : pv bit3 : tq bit4 : reserved (0) bit5 : hm bit6 : ip bit7 : csp bit8 : csv bit9 : cst bit10-31 : reserved (0)</p>

Chapter 11 FAQ and Troubleshooting



11

Contents

11.1 About this chapter.....	11-1
11.2 Self-diagnosis.....	11-2
11.3 P1-ECT troubleshooting.....	11-3
11.3.1 Verify the LED	11-3
11.3.2 Verifying using EtherCAT	11-4
11.4 Inverter troubleshooting.....	11-6
11.4.1 Inverter error information	11-6

11.1 About this chapter

This chapter contains the troubleshooting of cases such as errors detected by the protection function, warnings given by the warning function, or some cases in which the device is not working properly.

Symbol	Definition
	Questions about a particular situation.
	Solution/Answer
	Precautions



- When the device is not working properly or there is any trouble, first of all read this chapter. Use the following sections as a reference when dealing with these situations.

11.2 Self-diagnosis

The EtherCAT communication is not working properly

✔ Not working properly
Refer to this guide page 11-3
「3. P1-ECT troubleshooting」

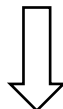

The inverter tripped.

✔ It is displaying an error.
Refer to this guide page 11-6
「4. Inverter troubleshooting」

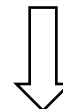

Cannot be solved

Please contact your supplier or Hitachi inverter technical service office.

Before contacting the technical service, please confirm the items on the right.

- (1) Inverter model,
- (2) Inverter manufacture number (MFG No.),
- (3) Option device model (P1-ECT),
- (4) P1-ECT manufacture number (MFG No.),
- (5) Date of purchase,
- (6) Inquiry contents,
- (7) The EtherCAT master being used.

For information about how to check the inverter model and the manufacture number (MFG No.) please refer to the inverter user's manual.

For information about how to check the P1-ECT model and the manufacture number (MFG No.) please refer to the chapter 4.

11.3 P1-ECT troubleshooting

11.3.1 Verify the LED

■ LED status

abbreviation	Description - status
ON	The LED is turned ON
OFF	The LED is turned OFF
F	Flickering The LED turns ON and OFF every 50[ms]
B	Blinking The LED turns ON and OFF every 200[ms]
SF	Single flash The LED turns ON for 200[ms] and OFF for 1000[ms] cyclically
DF	Double flash The LED turns ON for 200[ms], OFF for 200[ms], ON for 200[ms] then OFF for 1000[ms] cyclically.
-	Undefined

■ Probable cause and its solution

RUN	ERR	LINK (IN/OUT)	Description	Probable cause	Solution
OFF	OFF	OFF	Power supply fault	The inverter power is not turned ON.	Please turn on the inverter power supply.
				The P1-ECT is not correctly attached.	Turn off the inverter, then detach and attach again the P1-ECT. After this, turn on the inverter again.
			P1-ECT is damaged	P1-ECT broke down	Please exchange the P1-ECT.
-	-	OFF	LINK is not established	The cable is not correctly connected.	Disconnect and connect again the cable. Or exchange the cable.
				Other connected devices are not turned on.	Turn on other connected devices.
-	-	ON	LINK is established but there is no transmission.	The EtherCAT master is not turned on	Turn on the EtherCAT master.
				A slave between the P1-ECT and the EtherCAT master is not turned on.	Turn on the other EtherCAT slaves.
OFF	-	-	Initial status	If it doesn't change to another status, the EtherCAT master configuration is incorrect	Please verify the EtherCAT configuration.
B	-	-	Pre-Operational status	If it doesn't change to another status, the EtherCAT master configuration is incorrect	Please verify the EtherCAT configuration.

SF		–	Safe-Operational status	If it doesn't change to another status, the EtherCAT master configuration is incorrect	Please verify the EtherCAT configuration. If it doesn't change to Operational, there is a possibility that an object that cannot be allocated on the RxPDO is being allocated.
	B	–	EtherCAT setting error		Please contact us, and let us know the conditions when it occurred, the EtherCAT master that is being used, other slaves being used and other equipment configuration.
	DF	–	Process data transmission time out	<ul style="list-style-type: none"> • It changed from Operational status to another status. • The EtherCAT master or a slave in between got shut down • The cable got unplugged. 	Verify that the EtherCAT master did not freeze. Verify the power supply and the other slaves, and verify the interconnecting cables If there is no problem with the power supply or the cable connection, please exchange the cables.
–	–	–	Cable failure	The cable does not meet the required specifications.	Please exchange the cable for a cable that meets the specifications described in the section 4.2.4.
				The cable is broken.	Please exchange the cable.
			Noise	There is an equipment close by that is generating noise.	Please implement measures to prevent noise.

11.3.2 Verifying using EtherCAT



- How do I use EtherCAT to check system abnormalities.



- Inverter trips and warning notifications can be verified using the object 0x6041 Statusword.
- In the event the inverter trips, the CiA402 state will shift to the Fault state. By using the Statusword it can be checked if the state has shifted to the Fault state or not.
- In case there is an inverter warning notification, the Statusword bit 7 will turn on.



- In case there is an EtherCAT communication abnormality, the status will shift to the Fault state. However, since the problem is the EtherCAT communication, the Statusword cannot be read until the communication gets restored.
- In case there are abnormalities between the inverter and the P1-ECT communication, warning notifications cannot be verified.
- In case there are abnormalities between the inverter and the P1-ECT communication, one of the trips between the 60, 69, 70, 79, 80 or 89 will occur.
- After the state have changed to the Fault state, it will remain in the Fault state even if the trip is restored by the trip reset. In order to change this status, perform the fault reset by turning on the bit 7 of the control word (object 0x6040).



- EtherCAT communication problems, inverter trips, warnings, P1-ECT EEPROM writing failures can be verified with the emergency messages.
- Any of the previous issues can also be verified using the object 0x603F Error code.
- Additionally, any of the issues mentioned above can be verified using the object 0x10F3 Diagnosis History, in which up to 8 messages, containing the issue information, can be stored in this object.



- When an issue is detected, the P1-ECT will send the emergency message to the EtherCAT master. For information about how to verify the emergency message, please refer to the EtherCAT master manual and/or the configuration tool manual.
- The object 0x60F3 will only have the latest error code. For reading this object, use the SDO communication or allocate it in the TxPDO communication.
- The object 0x10F3 can be read by using the SDO communication. In case the master configuration tool can read this object refer to the configuration tool manual.

11.4 Inverter troubleshooting

11.4.1 Inverter error information

E060 / E069

Option 1 Error 0 / 9

E070 / E079

Option 2 Error 0 / 9

E080 / E089

Option 3 Error 0 / 9

E060 / E069
E070 / E079
E080 / E089

When there is a communication error between the P1-ECT and the inverter, an inverter error will occur.

In case the communication error was detected by the P1-ECT, the error number will be E060, E070 or E080.

In case the communication error was detected by the inverter, the error number will be E069, E079 or E089.

The error code will depend on the slot in which the P1-ECT is attached.

Issue▶	Possible cause▶	Possible solution
<p>An error occurred in the communication between the P1-ECT and the inverter</p>	<ul style="list-style-type: none"> • The P1-ECT is not correctly attached. 	<ul style="list-style-type: none"> • Turn off the inverter, then detach the P1-ECT and attach it again. After this, turn on the inverter again.
	<ul style="list-style-type: none"> • There is an intruding object in between the P1-ECT and the inverter connector 	<ul style="list-style-type: none"> • Remove the intruding object

E063**Option 1 Error 3****E073****Option 2 Error 3****E083****Option 3 Error 3****E063****E073****E083**

The P1-ECT detected an EtherCAT communication failure.

The error code will depend on the slot in which the P1-ECT is attached.

Issue▶	Possible cause ▶	Possible solution
There is an EtherCAT communication error.	<ul style="list-style-type: none"> • The status shifted from the operational status to another status. 	<ul style="list-style-type: none"> • Verify that the EtherCAT master did not freeze.
	<ul style="list-style-type: none"> • The EtherCAT master or a slave in between the EtherCAT master and the P1-ECT was turned off 	<ul style="list-style-type: none"> • Verify the power supply of the master and the other connected slaves.
	<ul style="list-style-type: none"> • The cable got disconnected. 	<ul style="list-style-type: none"> • Verify that the cable is connected correctly. • Check if the cable specification meets the required specifications. If it doesn't, please exchange the cable.

(Memo)

12

Chapter 12 Specifications

Contents

12.1 About this chapter.....	12-1
12.2 Device specifications.....	12-2

12.1 About this chapter

This chapter contains information about the P1-ECT specifications.

12.2 Device specifications

■ Specifications

Item		Specification	
Model		P1-ECT	
Dimensions (width×height×depth)		20.5×98.0×54.5mm	
Weight		170g	
Environment	Ambient operating temperature	-10~50°C	No icing or condensation conditions.
	Ambient operating humidity	20~90%RH	
	Storage temperature	-20~65°C	
	Vibration resistance	5.9m/s ² (0.6G)、10~55Hz	
	Conformance to EMC and electrical safety standards	IEC/EN61800-3 Second environment, Category C3 IEC/EN61800-5-1 SELV	
	Enclosure rating	IP00	
EtherCAT Interface	Communication protocol	EtherCAT CiA402 Drive profile 	
	Physical layer	100BASE-TX (IEEE802.3)	
	Connector	RJ45 (IN / OUT)	
	Communication distance	Distance between nodes: 100[m]max	
	Station address*1	1~99 : Set by the address setting switch 1~65535 : Set by configuration	
	Distributed clock	Free run mode (asynchronous)	
	Process data	PDO free mapping	
	Mailbox (CoE)	Emergency messages SDO requests SDO responses Abort SDO	
CiA402 drive profile	Velocity mode		

*1 The station address setting depends on the addressing mode used by the EtherCAT master. When using the Fixed addressing mode the address set by the address setting switch becomes enabled. When Auto Increment Addressing or Logical Addressing are being used the master will set up the slave address, thus the address set by the address setting switch becomes disabled.

13

Chapter 13 Parameter List

Contents

13.1 About this chapter.....	13-1
13.2 Parameter list.....	13-2
13.2.1 Code-d	13-2
13.2.2 Code-F	13-17
13.2.3 Code-A	13-18
13.2.4 Code-b	13-35
13.2.5 Code-C	13-43
13.2.6 Code-H	13-55
13.2.7 Code-o	13-65
13.2.8 Code-P	13-76
13.2.9 Code-U	13-78
13.2.10 Others	13-85

13.1 About this chapter

This chapter contains the list of parameter that can be accessed through the P1-ECT.

13.2 Parameter list

List of parameters that can be accessed through the P1-ECT

For information about the CoE communication area or the device profile area, please refer to the chapter 10 “Object Dictionary”

■ Items on the List

Item	Description
Index	Object index. Necessary when accessing the parameter through EtherCAT.
Sub-index	Object sub-index. Necessary when accessing the parameter through EtherCAT.
Func code	Parameter function code.
Function name	Parameter name.
Type	Parameter type INT : (16 bits signed) UINT : (16 bits unsigned) DINT : (32 bits signed) UDINT : (32 bits unsigned)
Access	RO : Read only WO : Write only RW : Read-Write
PDO	PDO : can be mapped in both TxPDO and RxPDO. TxPDO : can be PDO mapped only in TxPDO NP : cannot be PDO mapped in neither TxPDO or RxPDO.
Setting Items	Range of Values
Data resolution·units	Resolution and units

13.2.1 Code-d

Index	Sub-index	Func code	Function name	Type	Access	PDO	Setting Items	Data resolution·units
0x3027	0x60	dA-01	Output frequency monitor	UINT	RO	TxPDO	0 ~ 59000	0.01Hz
0x3027	0x61	dA-02	Output current monitor	UINT	RO	TxPDO	0 ~ 65535	0.01A
0x3027	0x62	dA-03	Rotation direction monitor	UINT	RO	TxPDO	0 ~ 3	1
0x4027	0x63	dA-04	Frequency reference monitor (After calculation)	DINT	RO	TxPDO	-59000 ~ 59000	0.01Hz
0x4027	0x65	dA-06	Output frequency scale conversion monitor	UDINT	RO	TxPDO	0 ~ 5900000	0.01
0x4027	0x67	dA-08	Detect speed monitor	DINT	RO	TxPDO	-59000 ~ 59000	0.01Hz
0x4027	0x6B	dA-12	Output frequency (+/-)	DINT	RO	TxPDO	-59000 ~ 59000	0.01Hz
0x3027	0x6D	dA-14	Frequency upper limit monitor	UINT	RO	TxPDO	0 ~ 59000	0.01Hz

Index	Sub-index	Func code	Function name	Type	Access	PDO	Setting Items	Data resolution -units
0x3027	0x6E	dA-15	Torque reference monitor (After calculation)	INT	RO	TxPDO	-10000 ~ 10000	0.1%
0x3027	0x6F	dA-16	Torque limit monitor	UINT	RO	TxPDO	0 ~ 5000	0.1%
0x3027	0x70	dA-17	Output Torque monitor	INT	RO	TxPDO	-10000 ~ 10000	0.1%
0x3027	0x71	dA-18	Output Voltage monitor	UINT	RO	TxPDO	0 ~ 8000	0.1v
0x4027	0x73	dA-20	Current position monitor	DINT	RO	TxPDO	-268435455 ~ 268435455 High resolution mode : -1073741823 ~ 1073741823	1pls
0x4027	0x79	dA-26	Pulse train position deviation monitor	DINT	RO	TxPDO	-2147483647 ~ 2147483647	1pls
0x4027	0x7B	dA-28	Pulse counter monitor	UDINT	RO	TxPDO	0 ~ 2147483647	1pls
0x3027	0x7D	dA-30	Input power monitor	UINT	RO	TxPDO	0 ~ 60000 (~132kW) 0~20000 (160kW~)	0.01kWh 0.1kWh
0x4027	0x7F	dA-32	Accumulation input power monitor	UDINT	RO	TxPDO	0 ~ 10000000	0.1kWh
0x3027	0x81	dA-34	Output power monitor	UINT	RO	TxPDO	0 ~ 60000 (~132kW) 0~20000 (160kW~)	0.01kWh 0.1kWh
0x4027	0x83	dA-36	Accumulation output power monitor	UDINT	RO	TxPDO	0 ~ 10000000	0.1kWh
0x3027	0x85	dA-38	Motor temperature monitor	INT	RO	TxPDO	-200 ~ 2000	0.1°C
0x3027	0x87	dA-40	DC-bus voltage monitor	UINT	RO	TxPDO	0 ~ 10000	0.1Vdc
0x3027	0x88	dA-41	BRD Load rating monitor	UINT	RO	TxPDO	0 ~ 10000	0.01%
0x3027	0x89	dA-42	Electronic thermal Load rating monitor (MTR)	UINT	RO	TxPDO	0 ~ 10000	0.01%
0x3027	0x8A	dA-43	Electronic thermal Load rating monitor (CTL)	UINT	RO	TxPDO	0 ~ 10000	0.01%
0x3027	0x8C	dA-45	Safety STO monitor	UINT	RO	TxPDO	0 ~ 7	1
0x3027	0x8D	dA-46	Safety option hardware monitor	UINT	RO	TxPDO	0 ~ 0xFFFF	1
0x3027	0x8E	dA-47	Safety option monitor	UINT	RO	TxPDO	0 ~ 6	1
0x3027	0x91	dA-50	Control terminal status	UINT	RO	TxPDO	0 ~ 15	1
0x3027	0x92	dA-51	Input terminal monitor	UINT	RO	TxPDO	0 ~ 0xFFFF	1
0x3027	0x95	dA-54	Output terminal monitor	UINT	RO	TxPDO	0 ~ 0xFF	1
0x3027	0x9B	dA-60	Analog input/output status monitor	UINT	RO	TxPDO	0 ~ 0xFF	1

Index	Sub-index	Func code	Function name	Type	Access	PDO	Setting Items	Data resolution -units
0x3027	0x9C	dA-61	Analog input Ai1 monitor	UINT	RO	TxPDO	0 ~ 10000	0.01%
0x3027	0x9D	dA-62	Analog input Ai2 monitor	UINT	RO	TxPDO	0 ~ 10000	0.01%
0x3027	0x9E	dA-63	Analog input Ai3 monitor	INT	RO	TxPDO	-10000 ~ 10000	0.01%
0x3027	0x9F	dA-64	Extension Analog input [Ai4] monitor	UINT	RO	TxPDO	0 ~ 10000	0.01%
0x3027	0xA0	dA-65	Extension Analog input [Ai5] monitor	UINT	RO	TxPDO	0 ~ 10000	0.01%
0x3027	0xA1	dA-66	Extension Analog input [Ai6] monitor	INT	RO	TxPDO	-10000 ~ 10000	0.01%
0x3027	0xA5	dA-70	Pulse train input monitor (internal)	INT	RO	TxPDO	-10000 ~ 10000	0.01%
0x3027	0xA6	dA-71	Pulse train input monitor (Option)	INT	RO	TxPDO	-10000 ~ 10000	0.01%
0x3027	0xB0	dA-81	Option slot-1 status	UINT	RO	TxPDO	0 ~ 48	1
0x3027	0xB1	dA-82	Option slot-2 status	UINT	RO	TxPDO	0 ~ 48	1
0x3027	0xB2	dA-83	Option slot-3 status	UINT	RO	TxPDO	0 ~ 48	1
0x3027	0xC4	db-01	Program download monitor	UINT	RO	TxPDO	0 ~ 1	1
0x3027	0xC5	db-02	Program No. monitor	UINT	RO	TxPDO	0 ~ 9999	1
0x3027	0xC6	db-03	Program counter (Task-1)	UINT	RO	TxPDO	1 ~ 1024	1
0x3027	0xC7	db-04	Program counter (Task-2)	UINT	RO	TxPDO	1 ~ 1024	1
0x3027	0xC8	db-05	Program counter (Task-3)	UINT	RO	TxPDO	1 ~ 1024	1
0x3027	0xC9	db-06	Program counter (Task-4)	UINT	RO	TxPDO	1 ~ 1024	1
0x3027	0xCA	db-07	Program counter (Task-5)	UINT	RO	TxPDO	1 ~ 1024	1
0x4027	0xCB	db-08	User monitor-0	DINT	RO	TxPDO	-2147483647 ~ 2147483647	1
0x4027	0xCD	db-10	User monitor-1	DINT	RO	TxPDO	-2147483647 ~ 2147483647	1
0x4027	0xCF	db-12	User monitor-2	DINT	RO	TxPDO	-2147483647 ~ 2147483647	1
0x4027	0xD1	db-14	User monitor-3	DINT	RO	TxPDO	-2147483647 ~ 2147483647	1
0x4027	0xD3	db-16	User monitor-4	DINT	RO	TxPDO	-2147483647 ~ 2147483647	1
0x3027	0xD5	db-18	Analog output monitor YA0	UINT	RO	TxPDO	0 ~ 10000	0.01%
0x3027	0xD6	db-19	Analog output monitor YA1	UINT	RO	TxPDO	0 ~ 10000	0.01%
0x3027	0xD7	db-20	Analog output monitor YA2	UINT	RO	TxPDO	0 ~ 10000	0.01%
0x3027	0xD8	db-21	Analog output monitor YA3	UINT	RO	TxPDO	0 ~ 10000	0.01%
0x3027	0xD9	db-22	Analog output monitor YA4	UINT	RO	TxPDO	0 ~ 10000	0.01%
0x3027	0xDA	db-23	Analog output monitor YA5	UINT	RO	TxPDO	0 ~ 10000	0.01%
0x4027	0xE1	db-30	PID1 Feedback value 1 monitor	DINT	RO	TxPDO	-10000 ~ 10000	Depends on AH-06

Index	Sub-index	Func code	Function name	Type	Access	PDO	Setting Items	Data resolution -units
0x4027	0xE3	db-32	PID1 Feedback value 2 monitor	DINT	RO	TxPDO	-10000 ~ 10000	Depends on AH-06
0x4027	0xE5	db-34	PID1 Feedback value 3 monitor	DINT	RO	TxPDO	-10000 ~ 10000	Depends on AH-06
0x4027	0xE7	db-36	PID2 Feedback value monitor	DINT	RO	TxPDO	-10000 ~ 10000	Depends on AJ-06
0x4027	0xE9	db-38	PID3 Feedback value monitor	DINT	RO	TxPDO	-10000 ~ 10000	Depends on AJ-26
0x4027	0xEB	db-40	PID4 Feedback value monitor	DINT	RO	TxPDO	-10000 ~ 10000	Depends on AJ-46
0x4027	0xED	db-42	PID1 SV	DINT	RO	TxPDO	-10000 ~ 10000	Depends on AH-06
0x4027	0xEF	db-44	PID1 PV	DINT	RO	TxPDO	-10000 ~ 10000	Depends on AH-06
0x3027	0xF5	db-50	PID1 Output monitor	INT	RO	TxPDO	-10000 ~ 10000	0.01%
0x3027	0xF6	db-51	PID1 Deviation monitor	INT	RO	TxPDO	-10000 ~ 10000	0.01%
0x3027	0xF7	db-52	PID1 Deviation 1 monitor	INT	RO	TxPDO	-10000 ~ 10000	0.01%
0x3027	0xF8	db-53	PID1 Deviation 2 monitor	INT	RO	TxPDO	-10000 ~ 10000	0.01%
0x3027	0xF9	db-54	PID1 Deviation 3 monitor	INT	RO	TxPDO	-10000 ~ 10000	0.01%
0x3027	0xFA	db-55	PID2 Output monitor	INT	RO	TxPDO	-10000 ~ 10000	0.01%
0x3027	0xFB	db-56	PID2 Deviation monitor	INT	RO	TxPDO	-10000 ~ 10000	0.01%
0x3027	0xFC	db-57	PID3 Output monitor	INT	RO	TxPDO	-10000 ~ 10000	0.01%
0x3027	0xFD	db-58	PID3 Deviation monitor	INT	RO	TxPDO	-10000 ~ 10000	0.01%
0x3027	0xFE	db-59	PID4 Output monitor	INT	RO	TxPDO	-10000 ~ 10000	0.01%
0x3028	0x1	db-60	PID4 Deviation monitor	INT	RO	TxPDO	-10000 ~ 10000	0.01%
0x3028	0x2	db-61	Current PID P-Gain monitor	UINT	RO	TxPDO	0 ~ 1000	0.1 times
0x3028	0x3	db-62	Current PID I-Gain monitor	UINT	RO	TxPDO	0 ~ 36000	0.1 s
0x3028	0x4	db-63	Current PID D-Gain monitor	UINT	RO	TxPDO	0 ~ 10000	0.01s
0x3028	0x5	db-64	PID FeedForward monitor	UINT	RO	TxPDO	0 ~ 10000	0.01%
0x3028	0x2A	dC-01	Inverter Load type status	UINT	RO	TxPDO	0 ~ 2	1
0x3028	0x2B	dC-02	Rated current monitor	UINT	RO	TxPDO	0 ~ 65535	0.1 a
0x3028	0x30	dC-07	Main speed input source monitor	UINT	RO	TxPDO	0 ~ 34	1
0x3028	0x31	dC-08	Sub speed input source monitor	UINT	RO	TxPDO	0 ~ 34	1
0x3028	0x33	dC-10	RUN command input source monitor	UINT	RO	TxPDO	0 ~ 6	1
0x3028	0x38	dC-15	Cooling-fin temperature monitor	INT	RO	TxPDO	-200 ~ 2000	0.1°C
0x3028	0x39	dC-16	Life assessment monitor	UINT	RO	TxPDO	0 ~ 0xFF	1

Index	Sub-index	Func code	Function name	Type	Access	PDO	Setting Items	Data resolution -units
0x3028	0x3D	dC-20	Accumulation Start number monitor	UINT	RO	TxPDO	1 ~ 65535	1
0x3028	0x3E	dC-21	Accumulation Power-on number monitor	UINT	RO	TxPDO	1 ~ 65535	1
0x4028	0x3F	dC-22	Accumulated time monitor in RUN status monitor	UDINT	RO	TxPDO	0 ~ 1000000	1hr
0x4028	0x41	dC-24	Accumulation power-on time monitor	UDINT	RO	TxPDO	0 ~ 1000000	1hr
0x4028	0x43	dC-26	Cooling fan accumulation running time monitor	UDINT	RO	TxPDO	0 ~ 1000000	1hr
0x3028	0x4E	dC-37	Icon2 LIM monitor	UINT	RO	TxPDO	0 ~ 6	1
0x3028	0x4F	dC-38	Icon2 ALT monitor	UINT	RO	TxPDO	0 ~ 4	1
0x3028	0x50	dC-39	Icon2 RETRY monitor	UINT	RO	TxPDO	0 ~ 2	1
0x3028	0x51	dC-40	Icon2 NRDY monitor	UINT	RO	TxPDO	0 ~ 9	1
0x3028	0x56	dC-45	IM/SM monitor	UINT	RO	TxPDO	0 ~ 1	1
0x3028	0x5B	dC-50	Firmware Ver. Monitor	UINT	RO	TxPDO	0 ~ 0xFFFF Top byte : Major Low Byte : Minor	1
0x3028	0x5E	dC-53	Firmware Gr.	UINT	RO	TxPDO	0 ~ 1	1
0x3028	0xF2	dE-01	Trip number monitor	UINT	RO	TxPDO	0 ~ 65535	1
0x3003	0xF0	dE-11	Trip monitor 1 Factor	UINT	RO	TxPDO	1 ~ 255	1
0x4003	0xF1	dE-11	Trip monitor 1 Output frequency (+/-)	DINT	RO	TxPDO	-59000 ~ 59000	0.01Hz
0x3003	0xF3	dE-11	Trip monitor 1 Output current	UINT	RO	TxPDO	0 ~ 65535	0.01A
0x3003	0xF4	dE-11	Trip monitor 1 DC-bus voltage	UINT	RO	TxPDO	0 ~ 10000	0.1Vdc
0x3003	0xF5	dE-11	Trip monitor 1 Inverter status	UINT	RO	TxPDO	0 ~ 8	1
0x3003	0xF6	dE-11	Trip monitor 1 LAD status	UINT	RO	TxPDO	0 ~ 5	1
0x3003	0xF7	dE-11	Trip monitor 1 Control mode	UINT	RO	TxPDO	0 ~ 11	1
0x3003	0xF8	dE-11	Trip monitor 1 Limit status	UINT	RO	TxPDO	0 ~ 6	1
0x3003	0xF9	dE-11	Trip monitor 1 Specific status	UINT	RO	TxPDO	0 ~ 6	1
0x4003	0xFB	dE-11	Trip monitor 1 Running time	UDINT	RO	TxPDO	0 ~ 1000000	1hr
0x4003	0xFD	dE-11	Trip monitor 1 Power-on time	UDINT	RO	TxPDO	0 ~ 1000000	1hr
0x3004	0x1	dE-11	Trip monitor 1 Time (Year/Month)	UINT	RO	TxPDO	00 ~ 99 (BCD code) 01 ~ 12 (BCD code)	1 1
0x3004	0x2	dE-11	Trip monitor 1 Time (Day)	UINT	RO	TxPDO	01 ~ 31 (BCD code) 00 ~ 06 (BCD code)	1 1

Index	Sub-index	Func code	Function name	Type	Access	PDO	Setting Items	Data resolution -units
0x3004	0x3	dE-11	Trip monitor 1 Time (Hour/Minute)	UINT	RO	TxPDO	00 ~ 23 (BCD code) 00 ~ 59 (BCD code)	1 1
0x3004	0x6	dE-12	Trip monitor 2 Factor	UINT	RO	TxPDO	1 ~ 255	1
0x4004	0x7	dE-12	Trip monitor 2 Output frequency (+/-)	DINT	RO	TxPDO	-59000 ~ 59000	0.01Hz
0x3004	0x9	dE-12	Trip monitor 2 Output current	UINT	RO	TxPDO	0 ~ 65535	0.01A
0x3004	0xA	dE-12	Trip monitor 2 DC-bus voltage	UINT	RO	TxPDO	0 ~ 10000	0.1Vdc
0x3004	0xB	dE-12	Trip monitor 2 Inverter status	UINT	RO	TxPDO	0 ~ 8	1
0x3004	0xC	dE-12	Trip monitor 2 LAD status	UINT	RO	TxPDO	0 ~ 5	1
0x3004	0xD	dE-12	Trip monitor 2 Control mode	UINT	RO	TxPDO	0 ~ 11	1
0x3004	0xE	dE-12	Trip monitor 2 Limit status	UINT	RO	TxPDO	0 ~ 6	1
0x3004	0xF	dE-12	Trip monitor 2 Specific status	UINT	RO	TxPDO	0 ~ 6	1
0x4004	0x11	dE-12	Trip monitor 2 Running time	UDINT	RO	TxPDO	0 ~ 1000000	1hr
0x4004	0x13	dE-12	Trip monitor 2 Power-on time	UDINT	RO	TxPDO	0 ~ 1000000	1hr
0x3004	0x15	dE-12	Trip monitor 2 Time (Year/Month)	UINT	RO	TxPDO	00 ~ 99 (BCD code) 01 ~ 12 (BCD code)	1 1
0x3004	0x16	dE-12	Trip monitor 2 Time (Day)	UINT	RO	TxPDO	01 ~ 31 (BCD code) 00 ~ 06 (BCD code)	1 1
0x3004	0x17	dE-12	Trip monitor 2 Time (Hour/Minute)	UINT	RO	TxPDO	00 ~ 23 (BCD code) 00 ~ 59 (BCD code)	1 1
0x3004	0x1A	dE-13	Trip monitor 3 Factor	UINT	RO	TxPDO	1 ~ 255	1
0x4004	0x1B	dE-13	Trip monitor 3 Output frequency (+/-)	DINT	RO	TxPDO	-59000 ~ 59000	0.01Hz
0x3004	0x1D	dE-13	Trip monitor 3 Output current	UINT	RO	TxPDO	0 ~ 65535	0.01A
0x3004	0x1E	dE-13	Trip monitor 3 DC-bus voltage	UINT	RO	TxPDO	0 ~ 10000	0.1Vdc
0x3004	0x1F	dE-13	Trip monitor 3 Inverter status	UINT	RO	TxPDO	0 ~ 8	1
0x3004	0x20	dE-13	Trip monitor 3 LAD status	UINT	RO	TxPDO	0 ~ 5	1
0x3004	0x21	dE-13	Trip monitor 3 Control mode	UINT	RO	TxPDO	0 ~ 11	1
0x3004	0x22	dE-13	Trip monitor 3 Limit status	UINT	RO	TxPDO	0 ~ 6	1
0x3004	0x23	dE-13	Trip monitor 3 Specific status	UINT	RO	TxPDO	0 ~ 6	1
0x4004	0x25	dE-13	Trip monitor 3 Running time	UDINT	RO	TxPDO	0 ~ 1000000	1hr
0x4004	0x27	dE-13	Trip monitor 3 Power-on time	UDINT	RO	TxPDO	0 ~ 1000000	1hr

Index	Sub-index	Func code	Function name	Type	Access	PDO	Setting Items	Data resolution -units
0x3004	0x29	dE-13	Trip monitor 3 Time (Year/Month)	UINT	RO	TxPDO	00 ~ 99 (BCD code) 01 ~ 12 (BCD code)	1 1
0x3004	0x2A	dE-13	Trip monitor 3 Time (Day)	UINT	RO	TxPDO	01 ~ 31 (BCD code) 00 ~ 06 (BCD code)	1 1
0x3004	0x2B	dE-13	Trip monitor 3 Time (Hour/Minute)	UINT	RO	TxPDO	00 ~ 23 (BCD code) 00 ~ 59 (BCD code)	1 1
0x3004	0x2E	dE-14	Trip monitor 4 Factor	UINT	RO	TxPDO	1 ~ 255	1
0x4004	0x2F	dE-14	Trip monitor 4 Output frequency (+/-)	DINT	RO	TxPDO	-59000 ~ 59000	0.01Hz
0x3004	0x31	dE-14	Trip monitor 4 Output current	UINT	RO	TxPDO	0 ~ 65535	0.01A
0x3004	0x32	dE-14	Trip monitor 4 DC-bus voltage	UINT	RO	TxPDO	0 ~ 10000	0.1Vdc
0x3004	0x33	dE-14	Trip monitor 4 Inverter status	UINT	RO	TxPDO	0 ~ 8	1
0x3004	0x34	dE-14	Trip monitor 4 LAD status	UINT	RO	TxPDO	0 ~ 5	1
0x3004	0x35	dE-14	Trip monitor 4 Control mode	UINT	RO	TxPDO	0 ~ 11	1
0x3004	0x36	dE-14	Trip monitor 4 Limit status	UINT	RO	TxPDO	0 ~ 6	1
0x3004	0x37	dE-14	Trip monitor 4 Specific status	UINT	RO	TxPDO	0 ~ 6	1
0x4004	0x39	dE-14	Trip monitor 4 Running time	UDINT	RO	TxPDO	0 ~ 1000000	1hr
0x4004	0x3B	dE-14	Trip monitor 4 Power-on time	UDINT	RO	TxPDO	0 ~ 1000000	1hr
0x3004	0x3D	dE-14	Trip monitor 4 Time (Year/Month)	UINT	RO	TxPDO	00 ~ 99 (BCD code) 01 ~ 12 (BCD code)	1 1
0x3004	0x3E	dE-14	Trip monitor 4 Time (Day)	UINT	RO	TxPDO	01 ~ 31 (BCD code) 00 ~ 06 (BCD code)	1 1
0x3004	0x3F	dE-14	Trip monitor 4 Time (Hour/Minute)	UINT	RO	TxPDO	00 ~ 23 (BCD code) 00 ~ 59 (BCD code)	1 1
0x3004	0x42	dE-15	Trip monitor 5 Factor	UINT	RO	TxPDO	1 ~ 255	1
0x4004	0x43	dE-15	Trip monitor 5 Output frequency (+/-)	DINT	RO	TxPDO	-59000 ~ 59000	0.01Hz
0x3004	0x45	dE-15	Trip monitor 5 Output current	UINT	RO	TxPDO	0 ~ 65535	0.01A
0x3004	0x46	dE-15	Trip monitor 5 DC-bus voltage	UINT	RO	TxPDO	0 ~ 10000	0.1Vdc
0x3004	0x47	dE-15	Trip monitor 5 Inverter status	UINT	RO	TxPDO	0 ~ 8	1
0x3004	0x48	dE-15	Trip monitor 5 LAD status	UINT	RO	TxPDO	0 ~ 5	1
0x3004	0x49	dE-15	Trip monitor 5 Control mode	UINT	RO	TxPDO	0 ~ 11	1
0x3004	0x4A	dE-15	Trip monitor 5 Limit status	UINT	RO	TxPDO	0 ~ 6	1
0x3004	0x4B	dE-15	Trip monitor 5 Specific status	UINT	RO	TxPDO	0 ~ 6	1

Index	Sub-index	Func code	Function name	Type	Access	PDO	Setting Items	Data resolution -units
0x4004	0x4D	dE-15	Trip monitor 5 Running time	UDINT	RO	TxPDO	0 ~ 1000000	1hr
0x4004	0x4F	dE-15	Trip monitor 5 Power-on time	UDINT	RO	TxPDO	0 ~ 1000000	1hr
0x3004	0x51	dE-15	Trip monitor 5 Time (Year/Month)	UINT	RO	TxPDO	00 ~ 99 (BCD code) 01 ~ 12 (BCD code)	1 1
0x3004	0x52	dE-15	Trip monitor 5 Time (Day)	UINT	RO	TxPDO	01 ~ 31 (BCD code) 00 ~ 06 (BCD code)	1 1
0x3004	0x53	dE-15	Trip monitor 5 Time (Hour/Minute)	UINT	RO	TxPDO	00 ~ 23 (BCD code) 00 ~ 59 (BCD code)	1 1
0x3004	0x56	dE-16	Trip monitor 6 Factor	UINT	RO	TxPDO	1 ~ 255	1
0x4004	0x57	dE-16	Trip monitor 6 Output frequency (+/-)	DINT	RO	TxPDO	-59000 ~ 59000	0.01Hz
0x3004	0x59	dE-16	Trip monitor 6 Output current	UINT	RO	TxPDO	0 ~ 65535	0.01A
0x3004	0x5A	dE-16	Trip monitor 6 DC-bus voltage	UINT	RO	TxPDO	0 ~ 10000	0.1Vdc
0x3004	0x5B	dE-16	Trip monitor 6 Inverter status	UINT	RO	TxPDO	0 ~ 8	1
0x3004	0x5C	dE-16	Trip monitor 6 LAD status	UINT	RO	TxPDO	0 ~ 5	1
0x3004	0x5D	dE-16	Trip monitor 6 Control mode	UINT	RO	TxPDO	0 ~ 11	1
0x3004	0x5E	dE-16	Trip monitor 6 Limit status	UINT	RO	TxPDO	0 ~ 6	1
0x3004	0x5F	dE-16	Trip monitor 6 Specific status	UINT	RO	TxPDO	0 ~ 6	1
0x4004	0x61	dE-16	Trip monitor 6 Running time	UDINT	RO	TxPDO	0 ~ 1000000	1hr
0x4004	0x63	dE-16	Trip monitor 6 Power-on time	UDINT	RO	TxPDO	0 ~ 1000000	1hr
0x3004	0x65	dE-16	Trip monitor 6 Time (Year/Month)	UINT	RO	TxPDO	00 ~ 99 (BCD code) 01 ~ 12 (BCD code)	1 1
0x3004	0x66	dE-16	Trip monitor 6 Time (Day)	UINT	RO	TxPDO	01 ~ 31 (BCD code) 00 ~ 06 (BCD code)	1 1
0x3004	0x67	dE-16	Trip monitor 6 Time (Hour/Minute)	UINT	RO	TxPDO	00 ~ 23 (BCD code) 00 ~ 59 (BCD code)	1 1
0x3004	0x6A	dE-17	Trip monitor 7 Factor	UINT	RO	TxPDO	1 ~ 255	1
0x4004	0x6B	dE-17	Trip monitor 7 Output frequency (+/-)	DINT	RO	TxPDO	-59000 ~ 59000	0.01Hz
0x3004	0x6D	dE-17	Trip monitor 7 Output current	UINT	RO	TxPDO	0 ~ 65535	0.01A
0x3004	0x6E	dE-17	Trip monitor 7 DC-bus voltage	UINT	RO	TxPDO	0 ~ 10000	0.1Vdc
0x3004	0x6F	dE-17	Trip monitor 7 Inverter status	UINT	RO	TxPDO	0 ~ 8	1
0x3004	0x70	dE-17	Trip monitor 7 LAD status	UINT	RO	TxPDO	0 ~ 5	1
0x3004	0x71	dE-17	Trip monitor 7 Control mode	UINT	RO	TxPDO	0 ~ 11	1

Index	Sub-index	Func code	Function name	Type	Access	PDO	Setting Items	Data resolution -units
0x3004	0x72	dE-17	Trip monitor 7 Limit status	UINT	RO	TxPDO	0 ~ 6	1
0x3004	0x73	dE-17	Trip monitor 7 Specific status	UINT	RO	TxPDO	0 ~ 6	1
0x4004	0x75	dE-17	Trip monitor 7 Running time	UDINT	RO	TxPDO	0 ~ 1000000	1hr
0x4004	0x77	dE-17	Trip monitor 7 Power-on time	UDINT	RO	TxPDO	0 ~ 1000000	1hr
0x3004	0x79	dE-17	Trip monitor 7 Time (Year/Month)	UINT	RO	TxPDO	00 ~ 99 (BCD code) 01 ~ 12 (BCD code)	1 1
0x3004	0x7A	dE-17	Trip monitor 7 Time (Day)	UINT	RO	TxPDO	01 ~ 31 (BCD code) 00 ~ 06 (BCD code)	1 1
0x3004	0x7B	dE-17	Trip monitor 7 Time (Hour/Minute)	UINT	RO	TxPDO	00 ~ 23 (BCD code) 00 ~ 59 (BCD code)	1 1
0x3004	0x7E	dE-18	Trip monitor 8 Factor	UINT	RO	TxPDO	1 ~ 255	1
0x4004	0x7F	dE-18	Trip monitor 8 Output frequency (+/-)	DINT	RO	TxPDO	-59000 ~ 59000	0.01Hz
0x3004	0x81	dE-18	Trip monitor 8 Output current	UINT	RO	TxPDO	0 ~ 65535	0.01A
0x3004	0x82	dE-18	Trip monitor 8 DC-bus voltage	UINT	RO	TxPDO	0 ~ 10000	0.1Vdc
0x3004	0x83	dE-18	Trip monitor 8 Inverter status	UINT	RO	TxPDO	0 ~ 8	1
0x3004	0x84	dE-18	Trip monitor 8 LAD status	UINT	RO	TxPDO	0 ~ 5	1
0x3004	0x85	dE-18	Trip monitor 8 Control mode	UINT	RO	TxPDO	0 ~ 11	1
0x3004	0x86	dE-18	Trip monitor 8 Limit status	UINT	RO	TxPDO	0 ~ 6	1
0x3004	0x87	dE-18	Trip monitor 8 Specific status	UINT	RO	TxPDO	0 ~ 6	1
0x4004	0x89	dE-18	Trip monitor 8 Running time	UDINT	RO	TxPDO	0 ~ 1000000	1hr
0x4004	0x8B	dE-18	Trip monitor 8 Power-on time	UDINT	RO	TxPDO	0 ~ 1000000	1hr
0x3004	0x8D	dE-18	Trip monitor 8 Time (Year/Month)	UINT	RO	TxPDO	00 ~ 99 (BCD code) 01 ~ 12 (BCD code)	1 1
0x3004	0x8E	dE-18	Trip monitor 8 Time (Day)	UINT	RO	TxPDO	01 ~ 31 (BCD code) 00 ~ 06 (BCD code)	1 1
0x3004	0x8F	dE-18	Trip monitor 8 Time (Hour/Minute)	UINT	RO	TxPDO	00 ~ 23 (BCD code) 00 ~ 59 (BCD code)	1 1
0x3004	0x92	dE-19	Trip monitor 9 Factor	UINT	RO	TxPDO	1 ~ 255	1
0x4004	0x93	dE-19	Trip monitor 9 Output frequency (+/-)	DINT	RO	TxPDO	-59000 ~ 59000	0.01Hz
0x3004	0x95	dE-19	Trip monitor 9 Output current	UINT	RO	TxPDO	0 ~ 65535	0.01A
0x3004	0x96	dE-19	Trip monitor 9 DC-bus voltage	UINT	RO	TxPDO	0 ~ 10000	0.1Vdc
0x3004	0x97	dE-19	Trip monitor 9 Inverter status	UINT	RO	TxPDO	0 ~ 8	1

Index	Sub-index	Func code	Function name	Type	Access	PDO	Setting Items	Data resolution -units
0x3004	0x98	dE-19	Trip monitor 9 LAD status	UINT	RO	TxPDO	0 ~ 5	1
0x3004	0x99	dE-19	Trip monitor 9 Control mode	UINT	RO	TxPDO	0 ~ 11	1
0x3004	0x9A	dE-19	Trip monitor 9 Limit status	UINT	RO	TxPDO	0 ~ 6	1
0x3004	0x9B	dE-19	Trip monitor 9 Specific status	UINT	RO	TxPDO	0 ~ 6	1
0x4004	0x9D	dE-19	Trip monitor 9 Running time	UDINT	RO	TxPDO	0 ~ 1000000	1hr
0x4004	0x9F	dE-19	Trip monitor 9 Power-on time	UDINT	RO	TxPDO	0 ~ 1000000	1hr
0x3004	0xA1	dE-19	Trip monitor 9 Time (Year/Month)	UINT	RO	TxPDO	00 ~ 99 (BCD code) 01 ~ 12 (BCD code)	1 1
0x3004	0xA2	dE-19	Trip monitor 9 Time (Day)	UINT	RO	TxPDO	01 ~ 31 (BCD code) 00 ~ 06 (BCD code)	1 1
0x3004	0xA3	dE-19	Trip monitor 9 Time (Hour/Minute)	UINT	RO	TxPDO	00 ~ 23 (BCD code) 00 ~ 59 (BCD code)	1 1
0x3004	0xA6	dE-20	Trip monitor 10 Factor	UINT	RO	TxPDO	1 ~ 255	1
0x4004	0xA7	dE-20	Trip monitor 10 Output frequency (+/-)	DINT	RO	TxPDO	-59000 ~ 59000	0.01Hz
0x3004	0xA9	dE-20	Trip monitor 10 Output current	UINT	RO	TxPDO	0 ~ 65535	0.01A
0x3004	0xAA	dE-20	Trip monitor 10 DC-bus voltage	UINT	RO	TxPDO	0 ~ 10000	0.1Vdc
0x3004	0xAB	dE-20	Trip monitor 10 Inverter status	UINT	RO	TxPDO	0 ~ 8	1
0x3004	0xAC	dE-20	Trip monitor 10 LAD status	UINT	RO	TxPDO	0 ~ 5	1
0x3004	0xAD	dE-20	Trip monitor 10 Control mode	UINT	RO	TxPDO	0 ~ 11	1
0x3004	0xAE	dE-20	Trip monitor 10 Limit status	UINT	RO	TxPDO	0 ~ 6	1
0x3004	0xAF	dE-20	Trip monitor 10 Specific status	UINT	RO	TxPDO	0 ~ 6	1
0x4004	0xB1	dE-20	Trip monitor 10 Running time	UDINT	RO	TxPDO	0 ~ 1000000	1hr
0x4004	0xB3	dE-20	Trip monitor 10 Power-on time	UDINT	RO	TxPDO	0 ~ 1000000	1hr
0x3004	0xB5	dE-20	Trip monitor 10 Time (Year/Month)	UINT	RO	TxPDO	00 ~ 99 (BCD code) 01 ~ 12 (BCD code)	1 1
0x3004	0xB6	dE-20	Trip monitor 10 Time (Day)	UINT	RO	TxPDO	01 ~ 31 (BCD code) 00 ~ 06 (BCD code)	1 1
0x3004	0xB7	dE-20	Trip monitor 10 Time (Hour/Minute)	UINT	RO	TxPDO	00 ~ 23 (BCD code) 00 ~ 59 (BCD code)	1 1
0x3004	0xBA	dE-31	Retry monitor 1 Factor	UINT	RO	TxPDO	1 ~ 255	1
0x4004	0xBB	dE-31	Retry monitor 1 Output frequency (+/-)	UDINT	RO	TxPDO	-59000 ~ 59000	0.01Hz
0x3004	0xBD	dE-31	Retry monitor 1 Output current	UINT	RO	TxPDO	0 ~ 65535	0.01A

Index	Sub-index	Func code	Function name	Type	Access	PDO	Setting Items	Data resolution -units
0x3004	0xBE	dE-31	Retry monitor 1 DC-bus voltage	UINT	RO	TxPDO	0 ~ 10000	0.1Vdc
0x3004	0xBF	dE-31	Retry monitor 1 Inverter status	UINT	RO	TxPDO	0 ~ 8	1
0x3004	0xC0	dE-31	Retry monitor 1 LAD status	UINT	RO	TxPDO	0 ~ 5	1
0x3004	0xC1	dE-31	Retry monitor 1 Control mode	UINT	RO	TxPDO	0 ~ 11	1
0x3004	0xC2	dE-31	Retry monitor 1 Limit status	UINT	RO	TxPDO	0 ~ 6	1
0x3004	0xC3	dE-31	Retry monitor 1 Specific status	UINT	RO	TxPDO	0 ~ 6	1
0x4004	0xC5	dE-31	Retry monitor 1 Running time	UDINT	RO	TxPDO	0 ~ 1000000	1hr
0x4004	0xC7	dE-31	Retry monitor 1 Power-on time	UDINT	RO	TxPDO	0 ~ 1000000	1hr
0x3004	0xC9	dE-31	Retry monitor 1 Time (Year/Month)	UINT	RO	TxPDO	00 ~ 99 (BCD code) 01 ~ 12 (BCD code)	1 1
0x3004	0xCA	dE-31	Retry monitor 1 Time (Day)	UINT	RO	TxPDO	01 ~ 31 (BCD code) 00 ~ 06 (BCD code)	1 1
0x3004	0xCB	dE-31	Retry monitor 1 Time (Hour/Minute)	UINT	RO	TxPDO	00 ~ 23 (BCD code) 00 ~ 59 (BCD code)	1 1
0x3004	0xCE	dE-32	Retry monitor 2 Factor	UINT	RO	TxPDO	1 ~ 255	1
0x4004	0xCF	dE-32	Retry monitor 2 Output frequency (+/-)	UDINT	RO	TxPDO	-59000 ~ 59000	0.01Hz
0x3004	0xD1	dE-32	Retry monitor 2 Output current	UINT	RO	TxPDO	0 ~ 65535	0.01A
0x3004	0xD2	dE-32	Retry monitor 2 DC-bus voltage	UINT	RO	TxPDO	0 ~ 10000	0.1Vdc
0x3004	0xD3	dE-32	Retry monitor 2 Inverter status	UINT	RO	TxPDO	0 ~ 8	1
0x3004	0xD4	dE-32	Retry monitor 2 LAD status	UINT	RO	TxPDO	0 ~ 5	1
0x3004	0xD5	dE-32	Retry monitor 2 Control mode	UINT	RO	TxPDO	0 ~ 11	1
0x3004	0xD6	dE-32	Retry monitor 2 Limit status	UINT	RO	TxPDO	0 ~ 6	1
0x3004	0xD7	dE-32	Retry monitor 2 Specific status	UINT	RO	TxPDO	0 ~ 6	1
0x4004	0xD9	dE-32	Retry monitor 2 Running time	UDINT	RO	TxPDO	0 ~ 1000000	1hr
0x4004	0xDB	dE-32	Retry monitor 2 Power-on time	UDINT	RO	TxPDO	0 ~ 1000000	1hr
0x3004	0xDD	dE-32	Retry monitor 2 Time (Year/Month)	UINT	RO	TxPDO	00 ~ 99 (BCD code) 01 ~ 12 (BCD code)	1 1
0x3004	0xDE	dE-32	Retry monitor 2 Time (Day)	UINT	RO	TxPDO	01 ~ 31 (BCD code) 00 ~ 06 (BCD code)	1 1
0x3004	0xDF	dE-32	Retry monitor 2 Time (Hour/Minute)	UINT	RO	TxPDO	00 ~ 23 (BCD code) 00 ~ 59 (BCD code)	1 1
0x3004	0xE2	dE-33	Retry monitor 3 Factor	UINT	RO	TxPDO	1 ~ 255	1

Index	Sub-index	Func code	Function name	Type	Access	PDO	Setting Items	Data resolution -units
0x4004	0xE3	dE-33	Retry monitor 3 Output frequency (+/-)	UDINT	RO	TxPDO	-59000 ~ 59000	0.01Hz
0x3004	0xE5	dE-33	Retry monitor 3 Output current	UINT	RO	TxPDO	0 ~ 65535	0.01A
0x3004	0xE6	dE-33	Retry monitor 3 DC-bus voltage	UINT	RO	TxPDO	0 ~ 10000	0.1Vdc
0x3004	0xE7	dE-33	Retry monitor 3 Inverter status	UINT	RO	TxPDO	0 ~ 8	1
0x3004	0xE8	dE-33	Retry monitor 3 LAD status	UINT	RO	TxPDO	0 ~ 5	1
0x3004	0xE9	dE-33	Retry monitor 3 Control mode	UINT	RO	TxPDO	0 ~ 11	1
0x3004	0xEA	dE-33	Retry monitor 3 Limit status	UINT	RO	TxPDO	0 ~ 6	1
0x3004	0xEB	dE-33	Retry monitor 3 Specific status	UINT	RO	TxPDO	0 ~ 6	1
0x4004	0xED	dE-33	Retry monitor 3 Running time	UDINT	RO	TxPDO	0 ~ 1000000	1hr
0x4004	0xEF	dE-33	Retry monitor 3 Power-on time	UDINT	RO	TxPDO	0 ~ 1000000	1hr
0x3004	0xF1	dE-33	Retry monitor 3 Time (Year/Month)	UINT	RO	TxPDO	00 ~ 99 (BCD code) 01 ~ 12 (BCD code)	1 1
0x3004	0xF2	dE-33	Retry monitor 3 Time (Day)	UINT	RO	TxPDO	01 ~ 31 (BCD code) 00 ~ 06 (BCD code)	1 1
0x3004	0xF3	dE-33	Retry monitor 3 Time (Hour/Minute)	UINT	RO	TxPDO	00 ~ 23 (BCD code) 00 ~ 59 (BCD code)	1 1
0x3004	0xF6	dE-34	Retry monitor 4 Factor	UINT	RO	TxPDO	1 ~ 255	1
0x4004	0xF7	dE-34	Retry monitor 4 Output frequency (+/-)	UDINT	RO	TxPDO	-59000 ~ 59000	0.01Hz
0x3004	0xF9	dE-34	Retry monitor 4 Output current	UINT	RO	TxPDO	0 ~ 65535	0.01A
0x3004	0xFA	dE-34	Retry monitor 4 DC-bus voltage	UINT	RO	TxPDO	0 ~ 10000	0.1Vdc
0x3004	0xFB	dE-34	Retry monitor 4 Inverter status	UINT	RO	TxPDO	0 ~ 8	1
0x3004	0xFC	dE-34	Retry monitor 4 LAD status	UINT	RO	TxPDO	0 ~ 5	1
0x3004	0xFD	dE-34	Retry monitor 4 Control mode	UINT	RO	TxPDO	0 ~ 11	1
0x3004	0xFE	dE-34	Retry monitor 4 Limit status	UINT	RO	TxPDO	0 ~ 6	1
0x3005	0x1	dE-34	Retry monitor 4 Specific status	UINT	RO	TxPDO	0 ~ 6	1
0x4005	0x3	dE-34	Retry monitor 4 Running time	UDINT	RO	TxPDO	0 ~ 1000000	1hr
0x4005	0x5	dE-34	Retry monitor 4 Power-on time	UDINT	RO	TxPDO	0 ~ 1000000	1hr
0x3005	0x7	dE-34	Retry monitor 4 Time (Year/Month)	UINT	RO	TxPDO	00 ~ 99 (BCD code) 01 ~ 12 (BCD code)	1 1
0x3005	0x8	dE-34	Retry monitor 4 Time (Day)	UINT	RO	TxPDO	01 ~ 31 (BCD code) 00 ~ 06 (BCD code)	1 1

Index	Sub-index	Func code	Function name	Type	Access	PDO	Setting Items	Data resolution -units
0x3005	0x9	dE-34	Retry monitor 4 Time (Hour/Minute)	UINT	RO	TxPDO	00 ~ 23 (BCD code) 00 ~ 59 (BCD code)	1 1
0x3005	0xC	dE-35	Retry monitor 5 Factor	UINT	RO	TxPDO	1 ~ 255	1
0x4005	0xD	dE-35	Retry monitor 5 Output frequency (+/-)	UDINT	RO	TxPDO	-59000 ~ 59000	0.01Hz
0x3005	0xF	dE-35	Retry monitor 5 Output current	UINT	RO	TxPDO	0 ~ 65535	0.01A
0x3005	0x10	dE-35	Retry monitor 5 DC-bus voltage	UINT	RO	TxPDO	0 ~ 10000	0.1Vdc
0x3005	0x11	dE-35	Retry monitor 5 Inverter status	UINT	RO	TxPDO	0 ~ 8	1
0x3005	0x12	dE-35	Retry monitor 5 LAD status	UINT	RO	TxPDO	0 ~ 5	1
0x3005	0x13	dE-35	Retry monitor 5 Control mode	UINT	RO	TxPDO	0 ~ 11	1
0x3005	0x14	dE-35	Retry monitor 5 Limit status	UINT	RO	TxPDO	0 ~ 6	1
0x3005	0x15	dE-35	Retry monitor 5 Specific status	UINT	RO	TxPDO	0 ~ 6	1
0x4005	0x17	dE-35	Retry monitor 5 Running time	UDINT	RO	TxPDO	0 ~ 1000000	1hr
0x4005	0x19	dE-35	Retry monitor 5 Power-on time	UDINT	RO	TxPDO	0 ~ 1000000	1hr
0x3005	0x1B	dE-35	Retry monitor 5 Time (Year/Month)	UINT	RO	TxPDO	00 ~ 99 (BCD code) 01 ~ 12 (BCD code)	1 1
0x3005	0x1C	dE-35	Retry monitor 5 Time (Day)	UINT	RO	TxPDO	01 ~ 31 (BCD code) 00 ~ 06 (BCD code)	1 1
0x3005	0x1D	dE-35	Retry monitor 5 Time (Hour/Minute)	UINT	RO	TxPDO	00 ~ 23 (BCD code) 00 ~ 59 (BCD code)	1 1
0x3005	0x20	dE-36	Retry monitor 6 Factor	UINT	RO	TxPDO	1 ~ 255	1
0x4005	0x21	dE-36	Retry monitor 6 Output frequency (+/-)	UDINT	RO	TxPDO	-59000 ~ 59000	0.01Hz
0x3005	0x23	dE-36	Retry monitor 6 Output current	UINT	RO	TxPDO	0 ~ 65535	0.01A
0x3005	0x24	dE-36	Retry monitor 6 DC-bus voltage	UINT	RO	TxPDO	0 ~ 10000	0.1Vdc
0x3005	0x25	dE-36	Retry monitor 6 Inverter status	UINT	RO	TxPDO	0 ~ 8	1
0x3005	0x26	dE-36	Retry monitor 6 LAD status	UINT	RO	TxPDO	0 ~ 5	1
0x3005	0x27	dE-36	Retry monitor 6 Control mode	UINT	RO	TxPDO	0 ~ 11	1
0x3005	0x28	dE-36	Retry monitor 6 Limit status	UINT	RO	TxPDO	0 ~ 6	1
0x3005	0x29	dE-36	Retry monitor 6 Specific status	UINT	RO	TxPDO	0 ~ 6	1
0x4005	0x2B	dE-36	Retry monitor 6 Running time	UDINT	RO	TxPDO	0 ~ 1000000	1hr
0x4005	0x2D	dE-36	Retry monitor 6 Power-on time	UDINT	RO	TxPDO	0 ~ 1000000	1hr

Index	Sub-index	Func code	Function name	Type	Access	PDO	Setting Items	Data resolution -units
0x3005	0x2F	dE-36	Retry monitor 6 Time (Year/Month)	UINT	RO	TxPDO	00 ~ 99 (BCD code) 01 ~ 12 (BCD code)	1 1
0x3005	0x30	dE-36	Retry monitor 6 Time (Day)	UINT	RO	TxPDO	01 ~ 31 (BCD code) 00 ~ 06 (BCD code)	1 1
0x3005	0x31	dE-36	Retry monitor 6 Time (Hour/Minute)	UINT	RO	TxPDO	00 ~ 23 (BCD code) 00 ~ 59 (BCD code)	1 1
0x3005	0x34	dE-37	Retry monitor 7 Factor	UINT	RO	TxPDO	1 ~ 255	1
0x4005	0x35	dE-37	Retry monitor 7 Output frequency (+/-)	UDINT	RO	TxPDO	-59000 ~ 59000	0.01Hz
0x3005	0x37	dE-37	Retry monitor 7 Output current	UINT	RO	TxPDO	0 ~ 65535	0.01A
0x3005	0x38	dE-37	Retry monitor 7 DC-bus voltage	UINT	RO	TxPDO	0 ~ 10000	0.1Vdc
0x3005	0x39	dE-37	Retry monitor 7 Inverter status	UINT	RO	TxPDO	0 ~ 8	1
0x3005	0x3A	dE-37	Retry monitor 7 LAD status	UINT	RO	TxPDO	0 ~ 5	1
0x3005	0x3B	dE-37	Retry monitor 7 Control mode	UINT	RO	TxPDO	0 ~ 11	1
0x3005	0x3C	dE-37	Retry monitor 7 Limit status	UINT	RO	TxPDO	0 ~ 6	1
0x3005	0x3D	dE-37	Retry monitor 7 Specific status	UINT	RO	TxPDO	0 ~ 6	1
0x4005	0x3F	dE-37	Retry monitor 7 Running time	UDINT	RO	TxPDO	0 ~ 1000000	1hr
0x4005	0x41	dE-37	Retry monitor 7 Power-on time	UDINT	RO	TxPDO	0 ~ 1000000	1hr
0x3005	0x43	dE-37	Retry monitor 7 Time (Year/Month)	UINT	RO	TxPDO	00 ~ 99 (BCD code) 01 ~ 12 (BCD code)	1 1
0x3005	0x44	dE-37	Retry monitor 7 Time (Day)	UINT	RO	TxPDO	01 ~ 31 (BCD code) 00 ~ 06 (BCD code)	1 1
0x3005	0x45	dE-37	Retry monitor 7 Time (Hour/Minute)	UINT	RO	TxPDO	00 ~ 23 (BCD code) 00 ~ 59 (BCD code)	1 1
0x3005	0x48	dE-38	Retry monitor 8 Factor	UINT	RO	TxPDO	1 ~ 255	1
0x4005	0x49	dE-38	Retry monitor 8 Output frequency (+/-)	UDINT	RO	TxPDO	-59000 ~ 59000	0.01Hz
0x3005	0x4B	dE-38	Retry monitor 8 Output current	UINT	RO	TxPDO	0 ~ 65535	0.01A
0x3005	0x4C	dE-38	Retry monitor 8 DC-bus voltage	UINT	RO	TxPDO	0 ~ 10000	0.1Vdc
0x3005	0x4D	dE-38	Retry monitor 8 Inverter status	UINT	RO	TxPDO	0 ~ 8	1
0x3005	0x4E	dE-38	Retry monitor 8 LAD status	UINT	RO	TxPDO	0 ~ 5	1
0x3005	0x4F	dE-38	Retry monitor 8 Control mode	UINT	RO	TxPDO	0 ~ 11	1
0x3005	0x50	dE-38	Retry monitor 8 Limit status	UINT	RO	TxPDO	0 ~ 6	1
0x3005	0x51	dE-38	Retry monitor 8 Specific status	UINT	RO	TxPDO	0 ~ 6	1

Index	Sub-index	Func code	Function name	Type	Access	PDO	Setting Items	Data resolution -units
0x4005	0x53	dE-38	Retry monitor 8 Running time	UDINT	RO	TxPDO	0 ~ 1000000	1hr
0x4005	0x55	dE-38	Retry monitor 8 Power-on time	UDINT	RO	TxPDO	0 ~ 1000000	1hr
0x3005	0x57	dE-38	Retry monitor 8 Time (Year/Month)	UINT	RO	TxPDO	00 ~ 99 (BCD code) 01 ~ 12 (BCD code)	1 1
0x3005	0x58	dE-38	Retry monitor 8 Time (Day)	UINT	RO	TxPDO	01 ~ 31 (BCD code) 00 ~ 06 (BCD code)	1 1
0x3005	0x59	dE-38	Retry monitor 8 Time (Hour/Minute)	UINT	RO	TxPDO	00 ~ 23 (BCD code) 00 ~ 59 (BCD code)	1 1
0x3005	0x5C	dE-39	Retry monitor 9 Factor	UINT	RO	TxPDO	1 ~ 255	1
0x4005	0x5D	dE-39	Retry monitor 9 Output frequency (+/-)	UDINT	RO	TxPDO	-59000 ~ 59000	0.01Hz
0x3005	0x5F	dE-39	Retry monitor 9 Output current	UINT	RO	TxPDO	0 ~ 65535	0.01A
0x3005	0x60	dE-39	Retry monitor 9 DC-bus voltage	UINT	RO	TxPDO	0 ~ 10000	0.1Vdc
0x3005	0x61	dE-39	Retry monitor 9 Inverter status	UINT	RO	TxPDO	0 ~ 8	1
0x3005	0x62	dE-39	Retry monitor 9 LAD status	UINT	RO	TxPDO	0 ~ 5	1
0x3005	0x63	dE-39	Retry monitor 9 Control mode	UINT	RO	TxPDO	0 ~ 11	1
0x3005	0x64	dE-39	Retry monitor 9 Limit status	UINT	RO	TxPDO	0 ~ 6	1
0x3005	0x65	dE-39	Retry monitor 9 Specific status	UINT	RO	TxPDO	0 ~ 6	1
0x4005	0x67	dE-39	Retry monitor 9 Running time	UDINT	RO	TxPDO	0 ~ 1000000	1hr
0x4005	0x69	dE-39	Retry monitor 9 Power-on time	UDINT	RO	TxPDO	0 ~ 1000000	1hr
0x3005	0x6B	dE-39	Retry monitor 9 Time (Year/Month)	UINT	RO	TxPDO	00 ~ 99 (BCD code) 01 ~ 12 (BCD code)	1 1
0x3005	0x6C	dE-39	Retry monitor 9 Time (Day)	UINT	RO	TxPDO	01 ~ 31 (BCD code) 00 ~ 06 (BCD code)	1 1
0x3005	0x6D	dE-39	Retry monitor 9 Time (Hour/Minute)	UINT	RO	TxPDO	00 ~ 23 (BCD code) 00 ~ 59 (BCD code)	1 1
0x3005	0x70	dE-40	Retry monitor 10 Factor	UINT	RO	TxPDO	1 ~ 255	1
0x4005	0x71	dE-40	Retry monitor 10 Output frequency (+/-)	UDINT	RO	TxPDO	-59000 ~ 59000	0.01Hz
0x3005	0x73	dE-40	Retry monitor 10 Output current	UINT	RO	TxPDO	0 ~ 65535	0.01A
0x3005	0x74	dE-40	Retry monitor 10 DC-bus voltage	UINT	RO	TxPDO	0 ~ 10000	0.1Vdc
0x3005	0x75	dE-40	Retry monitor 10 Inverter status	UINT	RO	TxPDO	0 ~ 8	1
0x3005	0x76	dE-40	Retry monitor 10 LAD status	UINT	RO	TxPDO	0 ~ 5	1
0x3005	0x77	dE-40	Retry monitor 10 Control mode	UINT	RO	TxPDO	0 ~ 11	1

Index	Sub-index	Func code	Function name	Type	Access	PDO	Setting Items	Data resolution -units
0x3005	0x78	dE-40	Retry monitor 10 Limit status	UINT	RO	TxPDO	0 ~ 6	1
0x3005	0x79	dE-40	Retry monitor 10 Specific status	UINT	RO	TxPDO	0 ~ 6	1
0x4005	0x7B	dE-40	Retry monitor 10 Running time	UDINT	RO	TxPDO	0 ~ 1000000	1hr
0x4005	0x7D	dE-40	Retry monitor 10 Power-on time	UDINT	RO	TxPDO	0 ~ 1000000	1hr
0x3005	0x7F	dE-40	Retry monitor 10 Time (Year/Month)	UINT	RO	TxPDO	00 ~ 99 (BCD code) 01 ~ 12 (BCD code)	1 1
0x3005	0x80	dE-40	Retry monitor 10 Time (Day)	UINT	RO	TxPDO	01 ~ 31 (BCD code) 00 ~ 06 (BCD code)	1 1
0x3005	0x81	dE-40	Retry monitor 10 Time (Hour/Minute)	UINT	RO	TxPDO	00 ~ 23 (BCD code) 00 ~ 59 (BCD code)	1 1
0x3005	0xE7	dE-50	Warning monitor	UINT	RO	TxPDO	0 ~ 65535	1

13.2.2 Code-F

Index	Sub-index	Func code	Function name	type	Access	PDO	Setting Items	Data resolution -units
0x302B	0x50	FA-01	Main Speed reference monitor	UINT	RO	TxPDO	0 ~ 59000	0.01Hz
0x402B	0x51	FA-02	Sub Speed reference monitor	DINT	RO	TxPDO	-59000 ~ 59000 (monitor) 0 ~ 59000 (setting)	0.01Hz
0x402B	0x59	FA-10	Acceleration time monitor	UDINT	RO	TxPDO	0 ~ 360000	0.01s
0x402B	0x5B	FA-12	Deceleration time monitor	UDINT	RO	TxPDO	0 ~ 360000	0.01s
0x302B	0x5E	FA-15	Torque reference monitor	INT	RO	TxPDO	-5000 ~ 5000	0.1%
0x302B	0x5F	FA-16	Torque bias monitor	INT	RO	TxPDO	-5000 ~ 5000	0.1%
0x402B	0x63	FA-20	Position reference monitor	DINT	RO	TxPDO	-268435455 ~ 268435455 High resolution mode : -1073741823 ~ 1073741823	1
0x402B	0x6D	FA-30	PID1 Set Value 1 monitor	DINT	RO	TxPDO	-10000 ~ 10000	Depends on AH-06
0x402B	0x6F	FA-32	PID1 Set Value 2 monitor	DINT	RO	TxPDO	-10000 ~ 10000	Depends on AH-06
0x402B	0x71	FA-34	PID1 Set Value 3 monitor	DINT	RO	TxPDO	-10000 ~ 10000	Depends on AH-06
0x402B	0x73	FA-36	PID2 Set Value monitor	DINT	RO	TxPDO	-10000 ~ 10000	Depends on AH-06
0x402B	0x75	FA-38	PID3 Set Value monitor	DINT	RO	TxPDO	-10000 ~ 10000	Depends on AH-26
0x402B	0x77	FA-40	PID4 Set Value monitor	DINT	RO	TxPDO	-10000 ~ 10000	Depends on AH-46

13.2.3 Code-A

Index	Sub-index	Func code	Function name	Type	Access	PDO	Setting Items	Data resolution ·units
0x302F	0x40	AA101	Main speed input source selection, 1st-motor	UINT	RW	TxPDO	1 ~ 16	1
0x302F	0x41	AA102	Sub frequency input source selection, 1st-motor	UINT	RW	TxPDO	0 ~ 16	1
0x302F	0x43	AA104	Sub speed setting, 1st-motor	UINT	RW	PDO	0 ~ 59000	0.01Hz
0x302F	0x44	AA105	Calculation symbol selection for Speed reference, 1st-motor	UINT	RW	PDO	0 ~ 3	1
0x402F	0x45	AA106	Add frequency setting, 1st-motor	DINT	RW	PDO	-59000 ~ 59000	0.01Hz
0x302F	0x4A	AA111	Run-command input source selection, 1st-motor	UINT	RW	TxPDO	0 ~ 6	1
0x302F	0x4B	AA-12	RUN-key Direction of Keypad, 1st-motor	UINT	RW	PDO	0 ~ 1	1
0x302F	0x4C	AA-13	STOP-key enable at RUN-command from terminal, 1st-motor	UINT	RW	PDO	0 ~ 2	1
0x302F	0x4D	AA114	RUN-direction restriction, 1st-motor	UINT	RW	TxPDO	0 ~ 2	1
0x302F	0x4E	AA115	STOP mode selection, 1st-motor	UINT	RW	TxPDO	0 ~ 1	1
0x302F	0x54	AA121	Control mode selection, 1st-motor	UINT	RW	TxPDO	0 ~ 12	1
0x302F	0x56	AA123	Vector control mode selection, 1st-motor	UINT	RW	TxPDO	0 ~ 3	1
0x3056	0x9E	AA201	Main speed input source selection, 2nd-motor	UINT	RW	TxPDO	1 ~ 16	1
0x3056	0x9F	AA202	Sub speed input source selection, 2nd-motor	UINT	RW	TxPDO	0 ~ 16	1
0x3056	0xA1	AA204	Sub speed setting, 2nd-motor	UINT	RW	PDO	0 ~ 59000	0.01Hz

Index	Sub-index	Func code	Function name	Type	Access	PDO	Setting Items	Data resolution -units
0x3056	0xA2	AA205	Calculation symbol selection for Speed reference, 2nd-motor	UINT	RW	PDO	0 ~ 3	1
0x4056	0xA3	AA206	Add frequency setting, 2nd-motor	DINT	RW	PDO	-59000 ~ 59000	0.01Hz
0x3056	0xA8	AA211	Run-command input source selection, 2nd-motor	UINT	RW	TxPDO	0 ~ 6	1
0x3056	0xAB	AA214	RUN-direction restriction, 1st-motor	UINT	RW	TxPDO	0 ~ 2	1
0x3056	0xAC	AA215	STOP mode selection, 1st-motor	UINT	RW	TxPDO	0 ~ 1	1
0x3056	0xB2	AA221	Control mode selection, 2nd-motor	UINT	RW	TxPDO	0 ~ 11	1
0x3056	0xB4	AA223	Vector control mode selection, 2nd-motor	UINT	RW	TxPDO	0 ~ 3	1
0x302F	0xA4	Ab-01	Frequency conversion gain	UINT	RW	PDO	1 ~ 10000	0.01
0x302F	0xA6	Ab-03	Multispeed operation selection	UINT	RW	TxPDO	0 ~ 1	1
0x302F	0xAD	Ab110	Multispeed-0 setting, 1st-motor	UINT	RW	PDO	0 ~ 59000	0.01Hz
0x302F	0xAE	Ab-11	Multispeed-1 setting	UINT	RW	PDO	0 ~ 59000	0.01Hz
0x302F	0xAF	Ab-12	Multispeed-2 setting	UINT	RW	PDO	0 ~ 59000	0.01Hz
0x302F	0xB0	Ab-13	Multispeed-3 setting	UINT	RW	PDO	0 ~ 59000	0.01Hz
0x302F	0xB1	Ab-14	Multispeed-4 setting	UINT	RW	PDO	0 ~ 59000	0.01Hz
0x302F	0xB2	Ab-15	Multispeed-5 setting	UINT	RW	PDO	0 ~ 59000	0.01Hz
0x302F	0xB3	Ab-16	Multispeed-6 setting	UINT	RW	PDO	0 ~ 59000	0.01Hz
0x302F	0xB4	Ab-17	Multispeed-7 setting	UINT	RW	PDO	0 ~ 59000	0.01Hz
0x302F	0xB5	Ab-18	Multispeed-8 setting	UINT	RW	PDO	0 ~ 59000	0.01Hz
0x302F	0xB6	Ab-19	Multispeed-9 setting	UINT	RW	PDO	0 ~ 59000	0.01Hz
0x302F	0xB7	Ab-20	Multispeed-10 setting	UINT	RW	PDO	0 ~ 59000	0.01Hz
0x302F	0xB8	Ab-21	Multispeed-11 setting	UINT	RW	PDO	0 ~ 59000	0.01Hz
0x302F	0xB9	Ab-22	Multispeed-12 setting	UINT	RW	PDO	0 ~ 59000	0.01Hz
0x302F	0xBA	Ab-23	Multispeed-13 setting	UINT	RW	PDO	0 ~ 59000	0.01Hz

Index	Sub-index	Func code	Function name	Type	Access	PDO	Setting Items	Data resolution -units
0x302F	0xBB	Ab-24	Multispeed-14 setting	UINT	RW	PDO	0 ~ 59000	0.01Hz
0x302F	0xBC	Ab-25	Multispeed-15 setting	UINT	RW	PDO	0 ~ 59000	0.01Hz
0x3057	0xD	Ab210	Multispeed-0 setting, 2nd-motor	UINT	RW	PDO	0 ~ 59000	0.01Hz
0x3030	0xA	AC-01	Acceleration/ Deceleration Time input selection	UINT	RW	TxPDO	0 ~ 4	1
0x3030	0xB	AC-02	Acceleration/ Deceleration Selection	UINT	RW	TxPDO	0 ~ 1	1
0x3030	0xC	AC-03	Acceleration curve selection	UINT	RW	TxPDO	0 ~ 4	1
0x3030	0xD	AC-04	Deceleration curve selection	UINT	RW	TxPDO	0 ~ 4	1
0x3030	0xE	AC-05	Acceleration curve constant setting	UINT	RW	TxPDO	1 ~ 10	1
0x3030	0xF	AC-06	Deceleration curve constant setting	UINT	RW	TxPDO	1 ~ 10	1
0x3030	0x11	AC-08	EL-S-curve ratio @start of acceleration	UINT	RW	TxPDO	0 ~ 100	1%
0x3030	0x12	AC-09	EL-S-curve ratio @end of acceleration	UINT	RW	TxPDO	0 ~ 100	1%
0x3030	0x13	AC-10	EL-S-curve ratio @start of deceleration	UINT	RW	TxPDO	0 ~ 100	1%
0x3030	0x14	AC-11	EL-S-curve ratio @end of deceleration	UINT	RW	TxPDO	0 ~ 100	1%
0x3030	0x18	AC115	Select method to switch to Accel2/Decel2 Profile, 1st-motor	UINT	RW	TxPDO	0 ~ 2	1
0x3030	0x19	AC116	Accel1 to Accel2 Frequency transition point, 1st-motor	UINT	RW	PDO	0 ~ 59000	0.01Hz
0x3030	0x1A	AC117	Decel1 to Decel2 Frequency transition point, 1st-motor	UINT	RW	PDO	0 ~ 59000	0.01Hz
0x4030	0x1D	AC120	Acceleration time setting 1, 1st-motor	UDINT	RW	PDO	0 ~ 360000	0.01s
0x4030	0x1F	AC122	Deceleration time setting 1, 1st-motor	UDINT	RW	PDO	0 ~ 360000	0.01s
0x4030	0x21	AC124	Acceleration time setting 2 1st-motor	UDINT	RW	PDO	0 ~ 360000	0.01s

Index	Sub-index	Func code	Function name	Type	Access	PDO	Setting Items	Data resolution -units
0x4030	0x23	AC126	Deceleration time setting 2, 1st-motor	UDINT	RW	PDO	0 ~ 360000	0.01s
0x4030	0x27	AC-30	Acceleration time setting for Multispeed-1	UDINT	RW	PDO	0 ~ 360000	0.01s
0x4030	0x29	AC-32	Deceleration time setting for Multispeed-1	UDINT	RW	PDO	0 ~ 360000	0.01s
0x4030	0x2B	AC-34	Acceleration time setting for Multispeed-2	UDINT	RW	PDO	0 ~ 360000	0.01s
0x4030	0x2D	AC-36	Deceleration time setting for Multispeed-2	UDINT	RW	PDO	0 ~ 360000	0.01s
0x4030	0x2F	AC-38	Acceleration time setting for Multispeed-3	UDINT	RW	PDO	0 ~ 360000	0.01s
0x4030	0x31	AC-40	Deceleration time setting for Multispeed-3	UDINT	RW	PDO	0 ~ 360000	0.01s
0x4030	0x33	AC-42	Acceleration time setting for Multispeed-4	UDINT	RW	PDO	0 ~ 360000	0.01s
0x4030	0x35	AC-44	Deceleration time setting for Multispeed-4	UDINT	RW	PDO	0 ~ 360000	0.01s
0x4030	0x37	AC-46	Acceleration time setting for Multispeed-5	UDINT	RW	PDO	0 ~ 360000	0.01s
0x4030	0x39	AC-48	Deceleration time setting for Multispeed-5	UDINT	RW	PDO	0 ~ 360000	0.01s
0x4030	0x3B	AC-50	Acceleration time setting for Multispeed-6	UDINT	RW	PDO	0 ~ 360000	0.01s
0x4030	0x3D	AC-52	Deceleration time setting for Multispeed-6	UDINT	RW	PDO	0 ~ 360000	0.01s
0x4030	0x3F	AC-54	Acceleration time setting for Multispeed-7	UDINT	RW	PDO	0 ~ 360000	0.01s
0x4030	0x41	AC-56	Deceleration time setting for Multispeed-7	UDINT	RW	PDO	0 ~ 360000	0.01s
0x4030	0x43	AC-58	Acceleration time setting for Multispeed-8	UDINT	RW	PDO	0 ~ 360000	0.01s
0x4030	0x45	AC-60	Deceleration time setting for Multispeed-8	UDINT	RW	PDO	0 ~ 360000	0.01s
0x4030	0x47	AC-62	Acceleration time setting for Multispeed-9	UDINT	RW	PDO	0 ~ 360000	0.01s
0x4030	0x49	AC-64	Deceleration time setting for Multispeed-9	UDINT	RW	PDO	0 ~ 360000	0.01s

Index	Sub-index	Func code	Function name	Type	Access	PDO	Setting Items	Data resolution -units
0x4030	0x4B	AC-66	Acceleration time setting for Multispeed-10	UDINT	RW	PDO	0 ~ 360000	0.01s
0x4030	0x4D	AC-68	Deceleration time setting for Multispeed-10	UDINT	RW	PDO	0 ~ 360000	0.01s
0x4030	0x4F	AC-70	Acceleration time setting for Multispeed-11	UDINT	RW	PDO	0 ~ 360000	0.01s
0x4030	0x51	AC-72	Deceleration time setting for Multispeed-11	UDINT	RW	PDO	0 ~ 360000	0.01s
0x4030	0x53	AC-74	Acceleration time setting for Multispeed-12	UDINT	RW	PDO	0 ~ 360000	0.01s
0x4030	0x55	AC-76	Deceleration time setting for Multispeed-12	UDINT	RW	PDO	0 ~ 360000	0.01s
0x4030	0x57	AC-78	Acceleration time setting for Multispeed-13	UDINT	RW	PDO	0 ~ 360000	0.01s
0x4030	0x59	AC-80	Deceleration time setting for Multispeed-13	UDINT	RW	PDO	0 ~ 360000	0.01s
0x4030	0x5B	AC-82	Acceleration time setting for Multispeed-14	UDINT	RW	PDO	0 ~ 360000	0.01s
0x4030	0x5D	AC-84	Deceleration time setting for Multispeed-14	UDINT	RW	PDO	0 ~ 360000	0.01s
0x4030	0x5F	AC-86	Acceleration time setting for Multispeed-15	UDINT	RW	PDO	0 ~ 360000	0.01s
0x4030	0x61	AC-88	Deceleration time setting for Multispeed-15	UDINT	RW	PDO	0 ~ 360000	0.01s
0x3057	0x76	AC215	Select method to switch to Accel2/Decel2 Profile, 2nd-motor	UINT	RW	TxPDO	0 ~ 2	1
0x3057	0x77	AC216	Accel1 to Accel2 Frequency transition point, 2nd-motor	UINT	RW	PDO	0 ~ 59000	0.01Hz
0x3057	0x78	AC217	Decel1 to Decel2 Frequency transition point, 2nd-motor	UINT	RW	PDO	0 ~ 59000	0.01Hz
0x4057	0x7B	AC220	Acceleration time setting 1, 2nd-motor	UDINT	RW	PDO	0 ~ 360000	0.01s
0x4057	0x7D	AC222	Deceleration time setting 1, 2nd-motor	UDINT	RW	PDO	0 ~ 360000	0.01s
0x4057	0x7F	AC224	Acceleration time setting 2, 2nd-motor	UDINT	RW	PDO	0 ~ 360000	0.01s

Index	Sub-index	Func code	Function name	Type	Access	PDO	Setting Items	Data resolution -units
0x4057	0x81	AC226	Deceleration time setting 2, 2nd-motor	UDINT	RW	PDO	0 ~ 360000	0.01s
0x3030	0x6E	Ad-01	Torque reference input source selection	UINT	RW	TxPDO	1 ~ 15	1
0x3030	0x6F	Ad-02	Torque reference value setting	INT	RW	PDO	-5000 ~ 5000	0.1%
0x3030	0x70	Ad-03	Polarity selection for torque reference	UINT	RW	TxPDO	0 ~ 1	1
0x3030	0x71	Ad-04	Switching time of Speed control to Torque control	UINT	RW	PDO	0 ~ 1000	1ms
0x3030	0x78	Ad-11	Torque bias input source selection	UINT	RW	TxPDO	0 ~ 15	1
0x3030	0x79	Ad-12	Torque bias value setting	INT	RW	PDO	-5000 ~ 5000	0.1%
0x3030	0x7A	Ad-13	Polarity selection for torque bias	UINT	RW	TxPDO	0 ~ 1	1
0x3030	0x7B	Ad-14	Term. [TBS] sel.	UINT	RW	TxPDO	0 ~ 1	1
0x3030	0x95	Ad-40	Input selection for speed limit at torque control	UINT	RW	TxPDO	1 ~ 13	1
0x3030	0x96	Ad-41	Speed limit at torque control (at Forward rotation)	UINT	RW	PDO	0 ~ 59000	0.01Hz
0x3030	0x97	Ad-42	Speed limit at torque control (at Reverse rotation)	UINT	RW	PDO	0 ~ 59000	0.01Hz
0x3030	0xD2	AE-01	Electronic gear setting point selection	UINT	RW	TxPDO	0 ~ 1	1
0x3030	0xD3	AE-02	Electronic gear ratio numerator	UINT	RW	PDO	1 ~ 10000	1
0x3030	0xD4	AE-03	Electronic gear ratio denominator	UINT	RW	PDO	1 ~ 10000	1
0x3030	0xD5	AE-04	Positioning complete range setting	UINT	RW	PDO	0 ~ 10000	1pls
0x3030	0xD6	AE-05	Positioning complete delay time setting	UINT	RW	PDO	0 ~ 1000	0.01s
0x3030	0xD7	AE-06	Position feed-forward gain setting	UINT	RW	PDO	0 ~ 65535	0.01
0x3030	0xD8	AE-07	Position loop gain setting	UINT	RW	PDO	0 ~ 10000	0.01
0x3030	0xD9	AE-08	Position bias setting	INT	RW	PDO	-2048 ~ 2048	1pls
0x3030	0xDB	AE-10	Stop position selection of Home search function	UINT	RW	TxPDO	0 ~ 3	1

Index	Sub-index	Func code	Function name	Type	Access	PDO	Setting Items	Data resolution -units
0x3030	0xDC	AE-11	Stop position of Home search function	UINT	RW	PDO	0 ~ 4095	1
0x3030	0xDD	AE-12	Speed reference of Home search function	UINT	RW	PDO	0 ~ 12000	0.01Hz
0x3030	0xDE	AE-13	Direction of Home search function	UINT	RW	TxPDO	0 ~ 1	1
0x4030	0xE5	AE-20	Position reference 0 setting	DINT	RW	PDO	-268435455 ~ 268435455 High resolution mode : -1073741823 ~ 1073741823	1pls
0x4030	0xE7	AE-22	Position reference 1 setting	DINT	RW	PDO	-268435455 ~ 268435455 High resolution mode : -1073741823 ~ 1073741823	1pls
0x4030	0xE9	AE-24	Position reference 2 setting	DINT	RW	PDO	-268435455 ~ 268435455 High resolution mode : -1073741823 ~ 1073741823	1pls
0x4030	0xEB	AE-26	Position reference 3 setting	DINT	RW	PDO	-268435455 ~ 268435455 High resolution mode : -1073741823 ~ 1073741823	1pls
0x4030	0xED	AE-28	Position reference 4 setting	DINT	RW	PDO	-268435455 ~ 268435455 High resolution mode : -1073741823 ~ 1073741823	1pls
0x4030	0xEF	AE-30	Position reference 5 setting	DINT	RW	PDO	-268435455 ~ 268435455 High resolution mode : -1073741823 ~ 1073741823	1pls
0x4030	0xF1	AE-32	Position reference 6 setting	DINT	RW	PDO	-268435455 ~ 268435455 High resolution mode : -1073741823 ~ 1073741823	1pls
0x4030	0xF3	AE-34	Position reference 7 setting	DINT	RW	PDO	-268435455 ~ 268435455 High resolution mode : -1073741823 ~ 1073741823	1pls
0x4030	0xF5	AE-36	Position reference 8 setting	DINT	RW	PDO	-268435455 ~ 268435455 High resolution mode : -1073741823 ~ 1073741823	1pls
0x4030	0xF7	AE-38	Position reference 9 setting	DINT	RW	PDO	-268435455 ~ 268435455 High resolution mode : -1073741823 ~ 1073741823	1pls
0x4030	0xF9	AE-40	Position reference 10 setting	DINT	RW	PDO	-268435455 ~ 268435455 High resolution mode : -1073741823 ~ 1073741823	1pls
0x4030	0xFB	AE-42	Position reference 11 setting	DINT	RW	PDO	-268435455 ~ 268435455 High resolution mode : -1073741823 ~ 1073741823	1pls
0x4030	0xFD	AE-44	Position reference 12 setting	DINT	RW	PDO	-268435455 ~ 268435455 High resolution mode : -1073741823 ~ 1073741823	1pls
0x4031	0x1	AE-46	Position reference 13 setting	DINT	RW	PDO	-268435455 ~ 268435455 High resolution mode : -1073741823 ~ 1073741823	1pls
0x4031	0x3	AE-48	Position reference 14 setting	DINT	RW	PDO	-268435455 ~ 268435455 High resolution mode : -1073741823 ~ 1073741823	1pls
0x4031	0x5	AE-50	Position reference 15 setting	DINT	RW	PDO	-268435455 ~ 268435455 High resolution mode : -1073741823 ~ 1073741823	1pls
0x4031	0x7	AE-52	Position control range setting(forward)	UDINT	RW	PDO	0 ~ 268435455 High resolution mode : 0 ~ 1073741823	1pls

Index	Sub-index	Func code	Function name	Type	Access	PDO	Setting Items	Data resolution -units
0x4031	0x9	AE-54	Position control range setting(reverse)	DINT	RW	PDO	-268435455 ~ 0 High resolution mode : -1073741823 ~ 0	1pls
0x3031	0xB	AE-56	Position control mode selection	UINT	RW	TxPDO	0 ~ 1	1
0x3031	0xF	AE-60	Teach-in function target selection	UINT	RW	PDO	0 ~ 15	1
0x3031	0x10	AE-61	Current position saving at power-off	UINT	RW	TxPDO	0 ~ 1	1
0x4031	0x11	AE-62	Preset position data	DINT	RW	PDO	-268435455 ~ 268435455 High resolution mode : -1073741823 ~ 1073741823	1pls
0x3031	0x13	AE-64	Deceleration stop distance calculation Gain	UINT	RW	PDO	5000 ~ 20000	0.01%
0x3031	0x14	AE-65	Deceleration stop distance calculation Bias	UINT	RW	PDO	0 ~ 65535	0.01%
0x3031	0x15	AE-66	Speed Limit in APR control	UINT	RW	PDO	0 ~ 10000	0.01%
0x3031	0x16	AE-67	APR start speed	UINT	RW	PDO	0 ~ 10000	0.01%
0x3031	0x19	AE-70	Homing function selection	UINT	RW	TxPDO	0 ~ 2	1
0x3031	0x1A	AE-71	Direction of Homing function	UINT	RW	TxPDO	0 ~ 1	1
0x3031	0x1B	AE-72	Low-speed of homing function	UINT	RW	PDO	0 ~ 1000	0.01Hz
0x3031	0x1C	AE-73	High-Speed of homing function	UINT	RW	PDO	0 ~ 59000	0.01Hz
0x3031	0x38	AF101	DC braking selection, 1st-motor	UINT	RW	TxPDO	0 ~ 2	1
0x3031	0x39	AF102	Braking type selection, 1st-motor	UINT	RW	TxPDO	0 ~ 2	1
0x3031	0x3A	AF103	DC braking frequency, 1st-motor	UINT	RW	PDO	0 ~ 59000	0.01Hz
0x3031	0x3B	AF104	DC braking delay time, 1st-motor	UINT	RW	PDO	0 ~ 500	0.01s
0x3031	0x3C	AF105	DC braking force setting, 1st-motor	UINT	RW	PDO	0 ~ 100	1%
0x3031	0x3D	AF106	DC braking active time at stop, 1st-motor	UINT	RW	PDO	0 ~ 6000	0.01s
0x3031	0x3E	AF107	DC braking operation method selection, 1st-motor	UINT	RW	PDO	0 ~ 1	1
0x3031	0x3F	AF108	DC braking force at start, 1st-motor	UINT	RW	PDO	0 ~ 100	1%
0x3031	0x40	AF109	DC braking active time at start, 1st-motor	UINT	RW	PDO	0 ~ 6000	0.01s

Index	Sub-index	Func code	Function name	Type	Access	PDO	Setting Items	Data resolution -units
0x3031	0x4B	AF120	ContactoControl Enable, 1st-motor	UINT	RW	TxPDO	0 ~ 2	1
0x3031	0x4C	AF121	Run delay time, 1st-motor	UINT	RW	PDO	0 ~ 200	0.01s
0x3031	0x4D	AF122	Contacto off delay time, 1st-motor	UINT	RW	PDO	0 ~ 200	0.01s
0x3031	0x4E	AF123	Contacto answer back check time, 1st-motor	UINT	RW	PDO	0 ~ 500	0.01s
0x3031	0x55	AF130	Brake Control Enable, 1st-motor	UINT	RW	TxPDO	0 ~ 3	1
0x3031	0x56	AF131	Brake Wait Time for Release, 1st-motor (Forward side)	UINT	RW	PDO	0 ~ 500	0.01s
0x3031	0x57	AF132	Brake Wait Time for Accel. , 1st-motor (Forward side)	UINT	RW	PDO	0 ~ 500	0.01s
0x3031	0x58	AF133	Brake Wait Time for Stopping, 1st-motor (Forward side)	UINT	RW	PDO	0 ~ 500	0.01s
0x3031	0x59	AF134	Brake Wait Time for Confirmation, 1st-motor (Forward side)	UINT	RW	PDO	0 ~ 500	0.01s
0x3031	0x5A	AF135	Brake Release Frequency Setting, 1st-motor (Forward side)	UINT	RW	PDO	0 ~ 59000	0.01Hz
0x3031	0x5B	AF136	Brake Release Current Setting, 1st-motor (Forward side)	UINT	RW	PDO	(0~2.00)*CTL Rated current	0.1A
0x3031	0x5C	AF137	Braking Frequency, 1st-motor (Forward side)	UINT	RW	PDO	0 ~ 59000	0.01Hz
0x3031	0x5D	AF138	Brake Wait Time for Release, 1st-motor (Reverse side)	UINT	RW	PDO	0 ~ 500	0.01s
0x3031	0x5E	AF139	Brake Wait Time for Accel. , 1st-motor (Reverse side)	UINT	RW	PDO	0 ~ 500	0.01s
0x3031	0x5F	AF140	Brake Wait Time for Stopping, 1st-motor (Reverse side)	UINT	RW	PDO	0 ~ 500	0.01s

Index	Sub-index	Func code	Function name	Type	Access	PDO	Setting Items	Data resolution -units
0x3031	0x60	AF141	Brake Wait Time for Confirmation, 1st-motor (Reverse side)	UINT	RW	PDO	0 ~ 500	0.01s
0x3031	0x61	AF142	Brake Release Frequency Setting, 1st-motor (Reverse side)	UINT	RW	PDO	0 ~ 59000	0.01Hz
0x3031	0x62	AF143	Brake Release Current Setting, 1st-motor (Reverse side)	UINT	RW	PDO	(0~2.00)*CTL Rated current	0.1A
0x3031	0x63	AF144	Braking Frequency, 1st-motor (Reverse side)	UINT	RW	PDO	0 ~ 59000	0.01Hz
0x3031	0x69	AF150	Brake open delay time, 1st-motor	UINT	RW	PDO	0 ~ 200	0.01s
0x3031	0x6A	AF151	Brake close delay time, 1st-motor	UINT	RW	PDO	0 ~ 200	0.01s
0x3031	0x6B	AF152	Brake answer back check time, 1st-motor	UINT	RW	PDO	0 ~ 500	0.01s
0x3031	0x6C	AF153	Servo lock/ DC injection time at start, 1st-motor	UINT	RW	PDO	0 ~ 1000	0.01s
0x3031	0x6D	AF154	Servo lock/ DC injection time at stop, 1st-motor	UINT	RW	PDO	0 ~ 1000	0.01s
0x3058	0x96	AF201	DC braking selection, 2nd-motor	UINT	RW	TxPDO	0 ~ 2	1
0x3058	0x97	AF202	Braking type selection, 2nd-motor	UINT	RW	TxPDO	0 ~ 2	1
0x3058	0x98	AF203	DC braking frequency, 1st-motor	UINT	RW	PDO	0 ~ 59000	0.01Hz
0x3058	0x99	AF204	DC braking delay time, 2nd-motor	UINT	RW	PDO	0 ~ 500	0.01s
0x3058	0x9A	AF205	DC braking force setting, 2nd-motor	UINT	RW	PDO	0 ~ 100	1%
0x3058	0x9B	AF206	DC braking active time at stop, 2nd-motor	UINT	RW	PDO	0 ~ 6000	0.01s
0x3058	0x9C	AF207	DC braking operation method selection, 2nd-motor	UINT	RW	PDO	0 ~ 1	1
0x3058	0x9D	AF208	DC braking force at start, 2nd-motor	UINT	RW	PDO	0 ~ 100	1%
0x3058	0x9E	AF209	DC braking active time at start, 2nd-motor	UINT	RW	PDO	0 ~ 6000	0.01s

Index	Sub-index	Func code	Function name	Type	Access	PDO	Setting Items	Data resolution -units
0x3058	0xA9	AF220	ContactoControl Enable, 2nd-motor	UINT	RW	TxPDO	0 ~ 2	1
0x3058	0xAA	AF221	Run delay time, 2nd-motor	UINT	RW	PDO	0 ~ 200	0.01s
0x3058	0xAB	AF222	Contacto off delay time, 2nd-motor	UINT	RW	PDO	0 ~ 200	0.01s
0x3058	0xAC	AF223	Contacto answer back check time, 2nd-motor	UINT	RW	PDO	0 ~ 500	0.01s
0x3058	0xB3	AF230	Brake Control Enable, 2nd-motor	UINT	RW	TxPDO	0 ~ 3	1
0x3058	0xB4	AF231	Brake Wait Time for Release, 2nd-motor (Forward side)	UINT	RW	PDO	0 ~ 500	0.01s
0x3058	0xB5	AF232	Brake Wait Time for Accel. , 2nd-motor (Forward side)	UINT	RW	PDO	0 ~ 500	0.01s
0x3058	0xB6	AF233	Brake Wait Time for Stopping, 2nd-motor (Forward side)	UINT	RW	PDO	0 ~ 500	0.01s
0x3058	0xB7	AF234	Brake Wait Time for Confirmation, 2nd-motor (Forward side)	UINT	RW	PDO	0 ~ 500	0.01s
0x3058	0xB8	AF235	Brake Release Frequency Setting, 2nd-motor (Forward side)	UINT	RW	PDO	0 ~ 59000	0.01Hz
0x3058	0xB9	AF236	Brake Release Current Setting, 2nd-motor (Forward side)	UINT	RW	PDO	(0~2.00)*CTL Rated current	0.1A
0x3058	0xBA	AF237	Braking Frequency, 2nd-motor (Forward side)	UINT	RW	PDO	0 ~ 59000	0.01Hz
0x3058	0xBB	AF238	Brake Wait Time for Release, 2nd-motor (Reverse side)	UINT	RW	PDO	0 ~ 500	0.01s
0x3058	0xBC	AF239	Brake Wait Time for Accel. , 2nd-motor (Reverse side)	UINT	RW	PDO	0 ~ 500	0.01s
0x3058	0xBD	AF240	Brake Wait Time for Stopping, 2nd-motor (Reverse side)	UINT	RW	PDO	0 ~ 500	0.01s

Index	Sub-index	Func code	Function name	Type	Access	PDO	Setting Items	Data resolution -units
0x3058	0xBE	AF241	Brake Wait Time for Confirmation, 2nd-motor (Reverse side)	UINT	RW	PDO	0 ~ 500	0.01s
0x3058	0xBF	AF242	Brake Release Frequency Setting, 2nd-motor (Reverse side)	UINT	RW	PDO	0 ~ 59000	0.01Hz
0x3058	0xC0	AF243	Brake Release Current Setting, 2nd-motor (Reverse side)	UINT	RW	PDO	(0~2.00)*CTL Rated current	0.1A
0x3058	0xC1	AF244	Braking Frequency, 2nd-motor (Reverse side)	UINT	RW	PDO	0 ~ 59000	0.01Hz
0x3058	0xC7	AF250	Brake open delay time, 2nd-motor	UINT	RW	PDO	0 ~ 200	0.01s
0x3058	0xC8	AF251	Brake close delay time, 2nd-motor	UINT	RW	PDO	0 ~ 200	0.01s
0x3058	0xC9	AF252	Brake answer back check time, 2nd-motor	UINT	RW	PDO	0 ~ 500	0.01s
0x3058	0xCA	AF253	Servo lock/ DC injection time at start, 2nd-motor	UINT	RW	PDO	0 ~ 1000	0.01s
0x3058	0xCB	AF254	Servo lock/ DC injection time at stop, 2nd-motor	UINT	RW	PDO	0 ~ 1000	0.01s
0x3031	0x9C	AG101	Jump frequency 1, 1st-motor	UINT	RW	PDO	0 ~ 59000	0.01Hz
0x3031	0x9D	AG102	Jump frequency width 1, 1st-motor	UINT	RW	PDO	0 ~ 1000	0.01Hz
0x3031	0x9E	AG103	Jump frequency 2, 1st-motor	UINT	RW	PDO	0 ~ 59000	0.01Hz
0x3031	0x9F	AG104	Jump frequency width 2, 1st-motor	UINT	RW	PDO	0 ~ 1000	0.01Hz
0x3031	0xA0	AG105	Jump frequency 3, 1st-motor	UINT	RW	PDO	0 ~ 59000	0.01Hz
0x3031	0xA1	AG106	Jump frequency width 3, 1st-motor	UINT	RW	PDO	0 ~ 1000	0.01Hz
0x3031	0xA5	AG110	Acceleration stop frequency setting, 1st-motor	UINT	RW	PDO	0 ~ 59000	0.01Hz
0x3031	0xA6	AG111	Acceleration stop time setting, 1st-motor	UINT	RW	PDO	0 ~ 600	0.1s
0x3031	0xA7	AG112	Deceleration stop frequency setting, 1st-motor	UINT	RW	PDO	0 ~ 59000	0.01Hz

Index	Sub-index	Func code	Function name	Type	Access	PDO	Setting Items	Data resolution -units
0x3031	0xA8	AG113	Deceleration stop time setting, 1st-motor	UINT	RW	PDO	0 ~ 600	0.1s
0x3031	0xAF	AG-20	Jogging frequency	UINT	RW	PDO	0 ~ 1000	0.01Hz
0x3031	0xB0	AG-21	Jogging stop mode selection	UINT	RW	TxPDO	0 ~ 5	1
0x3058	0xFA	AG201	Jump frequency 1, 2nd-motor	UINT	RW	PDO	0 - 59000	0.01Hz
0x3058	0xFB	AG202	Jump frequency width 1, 2nd-motor	UINT	RW	PDO	0 - 1000	0.01Hz
0x3058	0xFC	AG203	Jump frequency 2, 2nd-motor	UINT	RW	PDO	0 - 59000	0.01Hz
0x3058	0xFD	AG204	Jump frequency width 2, 2nd-motor	UINT	RW	PDO	0 - 1000	0.01Hz
0x3058	0xFE	AG205	Jump frequency 3, 2nd-motor	UINT	RW	PDO	0 - 59000	0.01Hz
0x3059	0x1	AG206	Jump frequency width 3, 2nd-motor	UINT	RW	PDO	0 - 1000	0.01Hz
0x3059	0x5	AG210	Acceleration stop frequency setting, 2nd-motor	UINT	RW	PDO	0 - 59000	0.01Hz
0x3059	0x6	AG211	Acceleration stop time setting, 2nd-motor	UINT	RW	PDO	0 - 600	0.1s
0x3059	0x7	AG212	Deceleration stop frequency setting, 2nd-motor	UINT	RW	PDO	0 - 59000	0.01Hz
0x3059	0x8	AG213	Deceleration stop time setting, 2nd-motor	UINT	RW	PDO	0 - 600	0.1s
0x3032	0x2	AH-01	PID1 enable	UINT	RW	TxPDO	0 ~ 2	1
0x3032	0x3	AH-02	PID1 deviation inverse	UINT	RW	TxPDO	0 ~ 1	1
0x3032	0x4	AH-03	Unit selection for PID1	UINT	RW	PDO	0 ~ 58	1
0x3032	0x5	AH-04	PID1 scale(0%) Adj.	INT	RW	PDO	-10000 ~ 10000	1
0x3032	0x6	AH-05	PID1 scale(100%) Adj.	INT	RW	PDO	-10000 ~ 10000	1
0x3032	0x7	AH-06	PID1 scale (point)	UINT	RW	PDO	0 ~ 4	1
0x3032	0x8	AH-07	Input source selection of Set-point for PID1	UINT	RW	TxPDO	0 ~ 13	1
0x4032	0xB	AH-10	Set-point-1 setting for PID1	DINT	RW	PDO	-10000 - 10000	Depends on AH-06
0x4032	0xD	AH-12	PID1 Multi stage set-point 1 setting	DINT	RW	PDO	-10000 - 10000	Depends on AH-06

Index	Sub-index	Func code	Function name	Type	Access	PDO	Setting Items	Data resolution -units
0x4032	0xF	AH-14	PID1 Multi stage set-point 2 setting	DINT	RW	PDO	-10000 - 10000	Depends on AH-06
0x4032	0x11	AH-16	PID1 Multi stage set-point 3 setting	DINT	RW	PDO	-10000 - 10000	Depends on AH-06
0x4032	0x13	AH-18	PID1 Multi stage set-point 4 setting	DINT	RW	PDO	-10000 - 10000	Depends on AH-06
0x4032	0x15	AH-20	PID1 Multi stage set-point 5 setting	DINT	RW	PDO	-10000 - 10000	Depends on AH-06
0x4032	0x17	AH-22	PID1 Multi stage set-point 6 setting	DINT	RW	PDO	-10000 - 10000	Depends on AH-06
0x4032	0x19	AH-24	PID1 Multi stage set-point 7 setting	DINT	RW	PDO	-10000 - 10000	Depends on AH-06
0x4032	0x1B	AH-26	PID1 Multi stage set-point 8 setting	DINT	RW	PDO	-10000 - 10000	Depends on AH-06
0x4032	0x1D	AH-28	PID1 Multi stage set-point 9 setting	DINT	RW	PDO	-10000 - 10000	Depends on AH-06
0x4032	0x1F	AH-30	PID1 Multi stage set-point 10 setting	DINT	RW	PDO	-10000 - 10000	Depends on AH-06
0x4032	0x21	AH-32	PID1 Multi stage set-point 11 setting	DINT	RW	PDO	-10000 - 10000	Depends on AH-06
0x4032	0x23	AH-34	PID1 Multi stage set-point 12 setting	DINT	RW	PDO	-10000 - 10000	Depends on AH-06
0x4032	0x25	AH-36	PID1 Multi stage set-point 13 setting	DINT	RW	PDO	-10000 - 10000	Depends on AH-06
0x4032	0x27	AH-38	PID1 Multi stage set-point 14 setting	DINT	RW	PDO	-10000 - 10000	Depends on AH-06
0x4032	0x29	AH-40	PID1 Multi stage set-point 15 setting	DINT	RW	PDO	-10000 - 10000	Depends on AH-06
0x3032	0x2B	AH-42	Input source selection of Set-point 2 for PID1	UINT	RW	TxPDO	0 - 13	1
0x4032	0x2D	AH-44	Set-point-2 setting for PID1	DINT	RW	PDO	-10000 - 10000	Depends on AH-06
0x3032	0x2F	AH-46	Input source selection of Set-point 3 for PID1	UINT	RW	TxPDO	0 ~ 13	1
0x4032	0x31	AH-48	Set-point-2 setting for PID1	DINT	RW	PDO	-10000 ~ 10000	Depends on AH-06
0x3032	0x33	AH-50	Calculation symbol selection of Set-point 1 for PID1	UINT	RW	PDO	1 ~ 6	1

Index	Sub-index	Func code	Function name	Type	Access	PDO	Setting Items	Data resolution -units
0x3032	0x34	AH-51	Input source selection of Process data 1 for PID1	UINT	RW	TxPDO	0 ~ 13	1
0x3032	0x35	AH-52	Input source selection of Process data 2 for PID1	UINT	RW	TxPDO	0 ~ 13	1
0x3032	0x36	AH-53	Input source selection of Process data 3 for PID1	UINT	RW	TxPDO	0 ~ 13	1
0x3032	0x37	AH-54	Calculation symbol selection of Process data for PID1	UINT	RW	PDO	1 ~ 10	1
0x3032	0x3D	AH-60	PID1 gain change method selection	UINT	RW	TxPDO	0 ~ 1	1
0x3032	0x3E	AH-61	PID1 proportional gain 1	UINT	RW	PDO	0 ~ 1000	0.1
0x3032	0x3F	AH-62	PID1 integral time constant 1	UINT	RW	PDO	0 ~ 36000	0.1s
0x3032	0x40	AH-63	PID1 derivative gain 1	UINT	RW	PDO	0 ~ 10000	0.01s
0x3032	0x41	AH-64	PID1 proportional gain 2	UINT	RW	PDO	0 ~ 1000	0.1
0x3032	0x42	AH-65	PID1 integral time constant 2	UINT	RW	PDO	0 ~ 36000	0.1s
0x3032	0x43	AH-66	PID1 derivative gain 2	UINT	RW	PDO	0 ~ 10000	0.01s
0x3032	0x44	AH-67	PID1 gain change time	UINT	RW	PDO	0 ~ 10000	1ms
0x3032	0x47	AH-70	PID feed-forward selection	UINT	RW	TxPDO	0 ~ 6	1
0x3032	0x48	AH-71	PID1 output range	UINT	RW	PDO	0 ~ 10000	0.01%
0x3032	0x49	AH-72	PID1 Deviation over level	UINT	RW	PDO	0 ~ 10000	0.01%
0x3032	0x4A	AH-73	PID1 Feedback compare signal turn-off level	UINT	RW	PDO	0 ~ 10000	0.01%
0x3032	0x4B	AH-74	PID1 Feedback compare signal turn-on level	UINT	RW	PDO	0 ~ 10000	0.01%
0x3032	0x4C	AH-75	PID soft start function enable	UINT	RW	TxPDO	0 ~ 1	1
0x3032	0x4D	AH-76	PID soft start target level	UINT	RW	PDO	0 ~ 10000	0.01%
0x4032	0x4F	AH-78	Acceleration time setting for PID soft start function	UDINT	RW	PDO	0 ~ 360000	0.01s
0x3032	0x51	AH-80	PID soft start time	UINT	RW	PDO	0 ~ 10000	0.01s
0x3032	0x52	AH-81	PID soft start error detection enable	UINT	RW	TxPDO	0 ~ 2	1

Index	Sub-index	Func code	Function name	Type	Access	PDO	Setting Items	Data resolution -units
0x3032	0x53	AH-82	PID soft start error detection level	UINT	RW	PDO	0 ~ 10000	0.01%
0x3032	0x56	AH-85	PID sleep trigger selection	UINT	RW	TxPDO	0 ~ 2	1
0x3032	0x57	AH-86	PID sleep start level	UINT	RW	PDO	0 ~ 59000	0.01Hz
0x3032	0x58	AH-87	PID sleep active time	UINT	RW	PDO	0 ~ 10000	0.01s
0x3032	0x59	AH-88	Setpoint boost before PID sleep enable	UINT	RW	TxPDO	0 ~ 1	1
0x3032	0x5A	AH-89	Setpoint boost time	UINT	RW	PDO	0 ~ 10000	0.01s
0x3032	0x5B	AH-90	Setpoint boost value	UINT	RW	PDO	0 ~ 10000	0.01%
0x3032	0x5C	AH-91	Minimum RUN time before PID sleep	UINT	RW	PDO	0 ~ 10000	0.01s
0x3032	0x5D	AH-92	Minimum active time of PID sleep	UINT	RW	PDO	0 ~ 10000	0.01s
0x3032	0x5E	AH-93	PID sleep trigger selection	UINT	RW	TxPDO	1 ~ 3	1
0x3032	0x5F	AH-94	PID wake start level	UINT	RW	PDO	0 ~ 10000	0.01%
0x3032	0x60	AH-95	PID wake start time	UINT	RW	PDO	0 ~ 10000	0.01s
0x3032	0x61	AH-96	PID wake start deviation value	UINT	RW	PDO	0 ~ 10000	0.01%
0x3032	0x66	AJ-01	PID2 enable	UINT	RW	TxPDO	0 ~ 2	1
0x3032	0x67	AJ-02	PID2 deviation inverse	UINT	RW	TxPDO	0 ~ 1	1
0x3032	0x68	AJ-03	PID2 unit selection	UINT	RW	PDO	0 ~ 58	1
0x3032	0x69	AJ-04	PID2 scale(0%) Adj.	INT	RW	PDO	-10000 ~ 10000	1
0x3032	0x6A	AJ-05	PID2 scale(100%) Adj.	INT	RW	PDO	-10000 ~ 10000	1
0x3032	0x6B	AJ-06	PID2 scale (point)	UINT	RW	PDO	0 ~ 4	1
0x3032	0x6C	AJ-07	Input source selection of Set-point for PID2	UINT	RW	TxPDO	0 ~ 15	1
0x4032	0x6F	AJ-10	Set-point setting for PID2	DINT	RW	PDO	-10000 ~ 10000	Depends on AH-06
0x3032	0x71	AJ-12	Input source selection of Process data for PID2	UINT	RW	TxPDO	0 ~ 13	1
0x3032	0x72	AJ-13	PID2 proportional gain	UINT	RW	PDO	0 ~ 1000	0.1
0x3032	0x73	AJ-14	PID2 integral time constant	UINT	RW	PDO	0 ~ 36000	0.1s
0x3032	0x74	AJ-15	PID2 derivative gain	UINT	RW	PDO	0 ~ 10000	0.01s
0x3032	0x75	AJ-16	PID2 output range	UINT	RW	PDO	0 ~ 10000	0.01%
0x3032	0x76	AJ-17	PID2 Deviation over level	UINT	RW	PDO	0 ~ 10000	0.01%

Index	Sub-index	Func code	Function name	Type	Access	PDO	Setting Items	Data resolution -units
0x3032	0x77	AJ-18	PID2 Feedback compare signal turn-off level	UINT	RW	PDO	0 ~ 10000	0.01%
0x3032	0x78	AJ-19	PID2 Feedback compare signal turn-on level	UINT	RW	PDO	0 ~ 10000	0.01%
0x3032	0x7A	AJ-21	PID3 enable	UINT	RW	TxPDO	0 ~ 2	1
0x3032	0x7B	AJ-22	PID3 deviation inverse	UINT	RW	TxPDO	0 ~ 1	1
0x3032	0x7C	AJ-23	PID3 unit selection	UINT	RW	PDO	0 ~ 58	1
0x3032	0x7D	AJ-24	PID3 scale(0%) Adj.	INT	RW	PDO	-10000 ~ 10000	1
0x3032	0x7E	AJ-25	PID3 scale(100%) Adj.	INT	RW	PDO	-10000 ~ 10000	1
0x3032	0x7F	AJ-26	PID3 scale (point)	UINT	RW	PDO	0 ~ 4	1
0x3032	0x80	AJ-27	Input source selection of Set-point for PID3	UINT	RW	TxPDO	0 ~ 13	1
0x4032	0x83	AJ-30	Set-point setting for PID3	DINT	RW	PDO	-10000 ~ 10000	Depends on AH-26
0x3032	0x85	AJ-32	Input source selection of Process data for PID3	UINT	RW	TxPDO	0 ~ 13	1
0x3032	0x86	AJ-33	PID3 proportional gain	UINT	RW	PDO	0 ~ 1000	0.1
0x3032	0x87	AJ-34	PID3 derivative gain	UINT	RW	PDO	0 ~ 36000	0.1s
0x3032	0x88	AJ-35	PID3 derivative gain	UINT	RW	PDO	0 ~ 10000	0.01s
0x3032	0x89	AJ-36	PID3 output range	UINT	RW	PDO	0 ~ 10000	0.01%
0x3032	0x8A	AJ-37	PID3 Deviation over level	UINT	RW	PDO	0 ~ 10000	0.01%
0x3032	0x8B	AJ-38	PID3 Feedback compare signal turn-off level	UINT	RW	PDO	0 ~ 10000	0.01%
0x3032	0x8C	AJ-39	PID3 Feedback compare signal turn-on level	UINT	RW	PDO	0 ~ 10000	0.01%
0x3032	0x8E	AJ-41	PID4 enable	UINT	RW	TxPDO	0 ~ 2	1
0x3032	0x8F	AJ-42	PID4 deviation inverse	UINT	RW	TxPDO	0 ~ 1	1
0x3032	0x90	AJ-43	PID4 unit selection	UINT	RW	PDO	0 ~ 58	1
0x3032	0x91	AJ-44	PID4 scale(0%) Adj.	INT	RW	PDO	-10000 ~ 10000	1
0x3032	0x92	AJ-45	PID4 scale(100%) Adj.	INT	RW	PDO	-10000 ~ 10000	1
0x3032	0x93	AJ-46	PID4 scale (point)	UINT	RW	PDO	0 ~ 4	1
0x3032	0x94	AJ-47	Input source selection of Set-point for PID4	UINT	RW	TxPDO	0 ~ 13	1

Index	Sub-index	Func code	Function name	Type	Access	PDO	Setting Items	Data resolution -units
0x4032	0x97	AJ-50	Set-point setting for PID4	DINT	RW	PDO	-10000 ~ 10000	Depends on AH-46
0x3032	0x99	AJ-52	Input source selection of Process data for PID4	UINT	RW	TxPDO	0 ~ 13	1
0x3032	0x9A	AJ-53	PID4 proportional gain	UINT	RW	PDO	0 ~ 1000	0.1
0x3032	0x9B	AJ-54	PID4 derivative gain	UINT	RW	PDO	0 ~ 36000	0.1s
0x3032	0x9C	AJ-55	PID4 derivative gain	UINT	RW	PDO	0 ~ 10000	0.01s
0x3032	0x9D	AJ-56	PID4 output range	UINT	RW	PDO	0 ~ 10000	0.01%
0x3032	0x9E	AJ-57	PID4 Deviation over level	UINT	RW	PDO	0 ~ 10000	0.01%
0x3032	0x9F	AJ-58	PID4 Feedback compare signal turn-off level	UINT	RW	PDO	0 ~ 10000	0.01%
0x3032	0xA0	AJ-59	PID4 Feedback compare signal turn-on level	UINT	RW	PDO	0 ~ 10000	0.01%

13.2.4 Code-b

Index	Sub-index	Func code	Function name	Type	Access	PDO	Setting Items	Data resolution -units
0x3033	0x30	bA101	Frequency limit selection, 1st-motor	UINT	RW	TxPDO	0 ~ 13	1
0x3033	0x31	bA102	Upper Frequency limit, 1st-motor	UINT	RW	PDO	0 ~ 59000	0.01Hz
0x3033	0x32	bA103	Lower Frequency limit, 1st-motor	UINT	RW	PDO	0 ~ 59000	0.01Hz
0x3033	0x39	bA110	Torque limit selection, 1st-motor	UINT	RW	TxPDO	0 ~ 11	1
0x3033	0x3A	bA111	TRQ limit mode 1st-motor	UINT	RW	TxPDO	0 ~ 1	1
0x3033	0x3B	bA112	Torque limit 1 (Forward driving), 1st-motor	UINT	RW	PDO	0 ~ 5000	0.1%
0x3033	0x3C	bA113	Torque limit 2 (Reverse regenerative), 1st-motor	UINT	RW	PDO	0 ~ 5000	0.1%
0x3033	0x3D	bA114	Torque limit 3 (Reverse driving), 1st-motor	UINT	RW	PDO	0 ~ 5000	0.1%
0x3033	0x3E	bA115	Torque limit 4 (Forward regenerative), 1st-motor	UINT	RW	PDO	0 ~ 5000	0.1%

Index	Sub-index	Func code	Function name	Type	Access	PDO	Setting Items	Data resolution -units
0x3033	0x3F	bA116	Torque limit LADSTOP selection, 1st-motor	UINT	RW	TxPDO	0 ~ 1	1
0x3033	0x43	bA120	Over current suppress enable, 1st-motor	UINT	RW	TxPDO	0 ~ 1	1
0x3033	0x44	bA121	Over current suppress Level, 1st-motor	UINT	RW	TxPDO	(0~2.00)*CTL Rated current	0.1A
0x3033	0x45	bA122	Overload restriction 1 mode selection, 1st-motor	UINT	RW	TxPDO	0 ~ 3	1
0x3033	0x46	bA123	Overload restriction 1 active level, 1st-motor	UINT	RW	PDO	(0.20~2.00)*CTL Rated current	0.1A
0x4033	0x47	bA124	Overload restriction 1 action time, 1st-motor	UDINT	RW	PDO	10 ~ 360000	0.01s
0x3033	0x49	bA126	Overload restriction 2 mode selection, 1st-motor	UINT	RW	TxPDO	0 ~ 3	1
0x3033	0x4A	bA127	Overload restriction 2 active level, 1st-motor	UINT	RW	PDO	(0.20~2.00)*CTL Rated current	0.1A
0x4033	0x4B	bA128	Overload restriction 2 Action time, 1st-motor	UDINT	RW	PDO	10 ~ 360000	0.01s
0x3033	0x4D	bA-30	Deceleration-stop at power failure	UINT	RW	TxPDO	0 ~ 3	1
0x3033	0x4E	bA-31	Decel.-stop at power failure starting voltage	UINT	RW	PDO	200V class: 0 ~ 4100 400V class: 0 ~ 8200	0.1Vdc
0x3033	0x4F	bA-32	Decel-stop at power failure control target level	UINT	RW	PDO	200V class: 0 ~ 4100 400V class: 0 ~ 8200	0.1Vdc
0x4033	0x51	bA-34	Decel-stop at power failure deceleration time	UDINT	RW	PDO	1 ~ 360000	0.01s
0x3033	0x53	bA-36	Decel-stop at power failure freq. width at deceleration start	UINT	RW	PDO	0 ~ 1000	0.01Hz
0x3033	0x54	bA-37	Decel-stop at power failure DC-bus voltage constant control P-gain	UINT	RW	PDO	0 ~ 500	0.01

Index	Sub-index	Func code	Function name	Type	Access	PDO	Setting Items	Data resolution -units
0x3033	0x55	bA-38	Decel-stop at power failure DC-bus voltage constant control I-gain	UINT	RW	PDO	0 ~ 15000	0.01s
0x3033	0x57	bA140	Over-voltage suppression enable, 1st-motor	UINT	RW	PDO	0 ~ 3	1
0x3033	0x58	bA141	Over-voltage suppression active level, 1st-motor	UINT	RW	PDO	200V class: 3300 ~ 4000 400V class: 6600 ~ 8000	0.1Vdc
0x4033	0x59	bA142	Over-voltage suppression action time, 1st-motor	UDINT	RW	PDO	0 ~ 360000	0.01s
0x3033	0x5B	bA144	DC bus constant control proportional gain, 1st-motor	UINT	RW	PDO	0 ~ 500	0.01
0x3033	0x5C	bA145	DC bus constant control integral gain, 1st-motor	UINT	RW	PDO	0 ~ 15000	0.01s
0x3033	0x5D	bA146	Over magnetization function selection, 1st_motor	UINT	RW	PDO	0 ~ 4	1
0x3033	0x5E	bA147	Over magnetization output filter time constant, 1st_motor	UINT	RW	PDO	0 ~ 100	0.01s
0x3033	0x5F	bA148	Over magnetization voltage gain, 1st_motor	UINT	RW	PDO	50 ~ 400	1%
0x3033	0x60	bA149	Over magnetization level setting, 1st_motor	UINT	RW	PDO	200V class: 3300 ~ 4000 400V class: 6600 ~ 8000	0.1Vdc
0x3033	0x6B	bA-60	Dynamic brake usage rate	UINT	RW	PDO	0 ~ 1000 (bA-63 と関連)	0.1%
0x3033	0x6C	bA-61	Dynamic brake selection	UINT	RW	TxPDO	0 ~ 2	1
0x3033	0x6D	bA-62	Dynamic brake active level	UINT	RW	TxPDO	200V class: 3300 ~ 4000 400V class: 6600 ~ 8000	0.1Vdc
0x3033	0x6E	bA-63	Dynamic brake resistor value	UINT	RW	TxPDO	Resistance minimum value ~ 600.0	0.1Ω
0x3033	0x75	bA-70	Cooling FAN control method selection	UINT	RW	PDO	0 ~ 2	1
0x3033	0x76	bA-71	Clear FAN time data	UINT	RW	PDO	0 ~ 1	1
0x305A	0x8E	bA201	Frequency limit selection, 2nd motor	UINT	RW	TxPDO	0 ~ 13	1

Index	Sub-index	Func code	Function name	Type	Access	PDO	Setting Items	Data resolution -units
0x305A	0x8F	bA202	Upper frequency limit, 2nd motor	UINT	RW	PDO	0 ~ 59000	0.01Hz
0x305A	0x90	bA203	Lower frequency limit, 2nd motor	UINT	RW	PDO	0 ~ 59000	0.01Hz
0x305A	0x97	bA210	Torque limit selection, 2nd-motor	UINT	RW	TxPDO	0 ~ 11	1
0x305A	0x98	bA211	TRQ limit mode_M2	UINT	RW	TxPDO	0 ~ 1	1
0x305A	0x99	bA212	Torque limit 1 (Forward driving), 2nd-motor	UINT	RW	PDO	0 ~ 5000	0.1%
0x305A	0x9A	bA213	Torque limit 2 (Reverse regenerative), 2nd-motor	UINT	RW	PDO	0 ~ 5000	0.1%
0x305A	0x9B	bA214	Torque limit 3 (Reverse driving), 2nd-motor	UINT	RW	PDO	0 ~ 5000	0.1%
0x305A	0x9C	bA215	Torque limit 4 (Forward regenerative), 2nd motor	UINT	RW	PDO	0 ~ 5000	0.1%
0x305A	0x9D	bA216	Torque limit LADSTOP selection, 2nd-motor	UINT	RW	TxPDO	0 ~ 1	1
0x305A	0xA1	bA220	Over current suppress enable, 2nd-motor	UINT	RW	TxPDO	0 ~ 1	1
0x305A	0xA2	bA221	Over current suppress Level, 2nd-motor	UINT	RW	TxPDO	(0-2.00)*CTL Rated current	0.1A
0x305A	0xA3	bA222	Overload restriction 1 mode selection, 2nd-motor	UINT	RW	TxPDO	0 ~ 3	1
0x305A	0xA4	bA223	Overload restriction 1 active level, 2nd-motor	UINT	RW	PDO	(0.20-2.00)*CTL Rated current	0.1A
0x405A	0xA5	bA224	Overload restriction 1 action time, 2nd-motor	UDINT	RW	PDO	10 ~ 360000	0.01s
0x305A	0xA7	bA226	Overload restriction 2 mode selection, 2nd-motor	UINT	RW	TxPDO	0 ~ 3	1
0x305A	0xA8	bA227	Overload restriction 2 active level, 2nd-motor	UINT	RW	PDO	(0.20-2.00)*CTL Rated current	0.1A
0x405A	0xA9	bA228	Overload restriction 2 action time, 2nd-motor	UDINT	RW	PDO	10 ~ 360000	0.01s

Index	Sub-index	Func code	Function name	Type	Access	PDO	Setting Items	Data resolution -units
0x305A	0xB5	bA240	Over-voltage suppression enable, 2nd-motor	UINT	RW	PDO	0 ~ 3	1
0x305A	0xB6	bA241	Over-voltage suppression active level, 2nd-motor	UINT	RW	PDO	200V class: 3300 ~ 4000 400V class: 6600 ~ 8000	0.1Vdc
0x405A	0xB7	bA242	Over-voltage suppression action time, 2nd-motor	UDINT	RW	PDO	0 ~ 360000	0.01s
0x305A	0xB9	bA244	DC bus constant control proportional gain, 2nd-motor	UINT	RW	PDO	0 ~ 500	0.01
0x305A	0xBA	bA245	DC bus constant control integral gain, 2nd-motor	UINT	RW	PDO	0 ~ 15000	0.01s
0x305A	0xBB	bA246	Over magnetization function selection, 2nd-motor	UINT	RW	PDO	0 ~ 4	1
0x305A	0xBC	bA247	Over magnetization output filter time constant, 2nd-motor	UINT	RW	PDO	0 ~ 100	0.01s
0x305A	0xBD	bA248	Over magnetization voltage gain, 2nd-motor	UINT	RW	PDO	50 ~ 400	1%
0x305A	0xBE	bA249	Over magnetization level setting, 2nd-motor	UINT	RW	PDO	200V class: 3300 ~ 4000 400V class: 6600 ~ 8000	0.1Vdc
0x3033	0x94	bb101	Carrier speed setting, 1st-motor	UINT	RW	PDO	5 ~ 160 (Depend on the capacity and the load)	0.1kHz
0x3033	0x95	bb102	Sprinkle carrier pattern selection, 1st-motor	UINT	RW	TxPDO	0 ~ 3	1
0x3033	0x96	bb103	Automatic-carrier reduction selection, 1st-motor	UINT	RW	PDO	0 ~ 2	1
0x3033	0x9D	bb-10	Automatic error reset selection	UINT	RW	TxPDO	0 ~ 2	1
0x3033	0x9E	bb-11	Alarm signal selection at Automatic error reset is active	UINT	RW	TxPDO	0 ~ 1	1
0x3033	0x9F	bb-12	Automatic error reset wait time	UINT	RW	PDO	0 ~ 600	1s
0x3033	0xA0	bb-13	Automatic error reset number	UINT	RW	TxPDO	0 ~ 10	1

Index	Sub-index	Func code	Function name	Type	Access	PDO	Setting Items	Data resolution -units
0x3033	0xA7	bb-20	The number of retries after instantaneous power failure	UINT	RW	PDO	0 ~ 16 / 255	1
0x3033	0xA8	bb-21	The number of retries after under voltage	UINT	RW	PDO	0 ~ 16 / 255	1
0x3033	0xA9	bb-22	The number of retries after over current	UINT	RW	PDO	0 ~ 5	1
0x3033	0xAA	bb-23	The number of retries after over voltag	UINT	RW	PDO	0 ~ 5	1
0x3033	0xAB	bb-24	Selection of restart mode @Instantaneous power failure/	UINT	RW	PDO	0 ~ 4	1
0x3033	0xAC	bb-25	Allowable under-voltage power failure time	UINT	RW	PDO	3 ~ 250	0.1s
0x3033	0xAD	bb-26	Retry wait time before motor restart	UINT	RW	PDO	3 ~ 1000	0.1s
0x3033	0xAE	bb-27	Instantaneous power failure/under-voltage trip alarm enable	UINT	RW	PDO	0 ~ 2	1
0x3033	0xAF	bb-28	Selection of restart mode @over-current	UINT	RW	PDO	0 ~ 4	1
0x3033	0xB0	bb-29	Wait time of restart @over-current	UINT	RW	PDO	3 ~ 1000	0.1s
0x3033	0xB1	bb-30	Selection of restart mode @over-voltage	UINT	RW	PDO	0 ~ 4	1
0x3033	0xB2	bb-31	Wait time of restart @over-voltage	UINT	RW	PDO	3 ~ 1000	0.1s
0x3033	0xBB	bb-40	Restart mode after FRS release	UINT	RW	PDO	0 ~ 3	1
0x3033	0xBC	bb-41	Restart mode after RS release	UINT	RW	PDO	0 ~ 3	1
0x3033	0xBD	bb-42	Restart frequency threshold	UINT	RW	PDO	0 ~ 59000	0.01Hz
0x3033	0xBE	bb-43	Restart level of Active frequency matching	UINT	RW	PDO	(0.20-2.00)*CTL Rated current	0.1A
0x3033	0xBF	bb-44	Restart constant (speed) of Active Frequency matching	UINT	RW	PDO	10 ~ 3000	0.01s

Index	Sub-index	Func code	Function name	Type	Access	PDO	Setting Items	Data resolution -units
0x3033	0xC0	bb-45	Restart constant (Voltage) of Active Frequency matching	UINT	RW	PDO	10 ~ 3000	0.01s
0x3033	0xC1	bb-46	OC-suppress level of Active frequency matching	UINT	RW	PDO	(0-2.00)*CTL Rated current	0.1A
0x3033	0xC2	bb-47	Restart speed selection of Active frequency matching	UINT	RW	PDO	0 ~ 2	1
0x3033	0xCF	bb160	Over current detection level, 1st-motor	UINT	RW	TxPDO	(0.20-2.20)*ND Rated current	0.1A
0x3033	0xD0	bb-61	Power supply over voltage selection	UINT	RW	PDO	0 ~ 1	1
0x3033	0xD1	bb-62	Power supply over voltage level setting	UINT	RW	PDO	200V class: 3000 ~ 4100 400V class: 6000 ~ 8200	0.1Vdc
0x3033	0xD3	bb-64	Ground fault selection	UINT	RW	TxPDO	0 ~ 1	1
0x3033	0xD4	bb-65	Input phase loss enable	UINT	RW	PDO	0 ~ 1	1
0x3033	0xD5	bb-66	Output phase loss enable	UINT	RW	PDO	0 ~ 1	1
0x3033	0xD6	bb-67	Output phase loss detection sensitivity	UINT	RW	PDO	1 ~ 100	1%
0x3033	0xD9	bb-70	Thermistor error level	UINT	RW	PDO	0 ~ 10000	1Ω
0x3033	0xE3	bb-80	Over speed detection level	UINT	RW	PDO	0 ~ 1500	0.1%
0x3033	0xE4	bb-81	Over speed detection time	UINT	RW	PDO	0 ~ 50	0.1s
0x3033	0xE5	bb-82	Speed deviation error mode selection	UINT	RW	TxPDO	0 ~ 1	1
0x3033	0xE6	bb-83	Speed deviation error detection level	UINT	RW	TxPDO	0 ~ 1000	0.1%
0x3033	0xE7	bb-84	Speed deviation error detection time	UINT	RW	TxPDO	0 ~ 50	0.1s
0x3033	0xE8	bb-85	Position deviation error mode selection	UINT	RW	TxPDO	0 ~ 1	1
0x3033	0xE9	bb-86	Position deviation error detection level	UINT	RW	TxPDO	0 ~ 65535 (*100pls)	1(*100pls)
0x3033	0xEA	bb-87	Position deviation error detection level	UINT	RW	TxPDO	0 ~ 50	0.1s
0x305A	0xF2	bb201	Carrier speed setting, 2nd-motor	UINT	RW	PDO	5 ~ 160 (Depend on the capacity and the load)	0.1kHz

Index	Sub-index	Func code	Function name	Type	Access	PDO	Setting Items	Data resolution -units
0x305A	0xF3	bb202	Sprinkle carrier pattern selection, 2nd-motor	UINT	RW	TxPDO	0 ~ 3	1
0x305A	0xF4	bb203	Automatic-carrier reduction selection, 2nd-motor	UINT	RW	PDO	0 ~ 2	1
0x305B	0x2F	bb260	Over current detection level, 2nd-motor	UINT	RW	TxPDO	(0.20~2.20)*ND Rated current	0.1A
0x3034	0x3	bc110	Electronic thermal level setting, 1st-motor	UINT	RW	PDO	(0 ~ 3.00)*CTL Rated current	0.1A
0x3034	0x4	bc111	Electronic thermal characteristic selection, 1st-motor	UINT	RW	PDO	0 ~ 2	1
0x3034	0x5	bc112	Electronic thermal Subtraction function enable, 1st-motor	UINT	RW	PDO	0 ~ 1	1
0x3034	0x6	bc113	Electronic thermal Subtraction time, 1st-motor	UINT	RW	PDO	1 ~ 1000	1s
0x3034	0x7	bc-14	Electronic thermal counter memory selection at Power-off	UINT	RW	PDO	0 ~ 1	1
0x3034	0xD	bc120	Free electronic thermal frequency-1, 1st-motor	UINT	RW	PDO	0 ~ 59000 (bc122)	0.01Hz
0x3034	0xE	bc121	Free electronic thermal current-1, 1st-motor	UINT	RW	PDO	(0 ~ 3.00)*CTL Rated current	0.1A
0x3034	0xF	bc122	Free electronic thermal frequency-2, 1st-motor	UINT	RW	PDO	0 ~ 59000 (bc120 ~ bc124)	0.01Hz
0x3034	0x10	bc123	Free electronic thermal current-2, 1st-motor	UINT	RW	PDO	(0 ~ 3.00)*CTL Rated current	0.1A
0x3034	0x11	bc124	Free electronic thermal frequency-3, 1st-motor	UINT	RW	PDO	0 (bc122) ~ 59000	0.01Hz
0x3034	0x12	bc125	Free electronic thermal current-3, 1st-motor	UINT	RW	PDO	(0~3.00)*CTL Rated current	0.1A

Index	Sub-index	Func code	Function name	Type	Access	PDO	Setting Items	Data resolution -units
0x305B	0x61	bC210	Electronic thermal level setting, 2nd-motor	UINT	RW	PDO	(0~3.00)*CTL Rated current	0.1A
0x305B	0x62	bC211	Electronic thermal characteristic selection, 2nd-motor	UINT	RW	PDO	0 ~ 2	1
0x305B	0x63	bC212	Electronic thermal Subtraction function enable, 2nd-motor	UINT	RW	PDO	0 ~ 1	1
0x305B	0x64	bC213	Electronic thermal Subtraction time, 2nd-motor	UINT	RW	PDO	1 ~ 1000	1s
0x305B	0x6B	bC220	Free electronic thermal frequency-1, 2nd-motor	UINT	RW	PDO	0 ~ 59000 (bC222)	0.01Hz
0x305B	0x6C	bC221	Free electronic thermal current-1, 2nd-motor	UINT	RW	PDO	(0 ~ 3.00)*CTL Rated current	0.1A
0x305B	0x6D	bC222	Free electronic thermal frequency-2, 2nd-motor	UINT	RW	PDO	0 ~ 59000 (bC220 ~ bC224)	0.01Hz
0x305B	0x6E	bC223	Free electronic thermal current-2, 2nd-motor	UINT	RW	PDO	(0 ~ 3.00)*CTL Rated current	0.1A
0x305B	0x6F	bC224	Free electronic thermal frequency-3, 2nd-motor	UINT	RW	PDO	0(bC222) ~ 59000	0.01Hz
0x305B	0x70	bC225	Free electronic thermal current-3, 2nd-motor	UINT	RW	PDO	(0~3.00)*CTL Rated current	0.1A
0x3034	0x5E	bd-01	STO input display selection	UINT	RW	TxPDO	0 ~ 2	1
0x3034	0x5F	bd-02	STO input change time	UINT	RW	TxPDO	0 ~ 6000	0.01s
0x3034	0x60	bd-03	Display selection at STO input change time	UINT	RW	TxPDO	0 ~ 1	1
0x3034	0x61	bd-04	Action selection after STO input change time	UINT	RW	TxPDO	0 ~ 2	1

13.2.5 Code-C

Index	Sub-index	Func code	Function name	Type	Access	PDO	Setting Items	Data resolution -units
-------	-----------	-----------	---------------	------	--------	-----	---------------	------------------------

Index	Sub-index	Func code	Function name	Type	Access	PDO	Setting Items	Data resolution -units
0x3037	0x20	CA-01	Input terminal [1] function	UINT	RW	PDO	0 ~ 110	1
0x3037	0x21	CA-02	Input terminal [2] function	UINT	RW	PDO	0 ~ 110	1
0x3037	0x22	CA-03	Input terminal [3] function	UINT	RW	PDO	0 ~ 110	1
0x3037	0x23	CA-04	Input terminal [4] function	UINT	RW	PDO	0 ~ 110	1
0x3037	0x24	CA-05	Input terminal [5] function	UINT	RW	PDO	0 ~ 110	1
0x3037	0x25	CA-06	Input terminal [6] function	UINT	RW	PDO	0 ~ 110	1
0x3037	0x26	CA-07	Input terminal [7] function	UINT	RW	PDO	0 ~ 110	1
0x3037	0x27	CA-08	Input terminal [8] function	UINT	RW	PDO	0 ~ 110	1
0x3037	0x28	CA-09	Input terminal [9] function	UINT	RW	PDO	0 ~ 110	1
0x3037	0x29	CA-10	Input terminal [A] function	UINT	RW	PDO	0 ~ 110	1
0x3037	0x2A	CA-11	Input terminal [B] function	UINT	RW	PDO	0 ~ 110	1
0x3037	0x34	CA-21	Input terminal [1] active state	UINT	RW	PDO	0 ~ 1	1
0x3037	0x35	CA-22	Input terminal [2] active state	UINT	RW	PDO	0 ~ 1	1
0x3037	0x36	CA-23	Input terminal [3] active state	UINT	RW	PDO	0 ~ 1	1
0x3037	0x37	CA-24	Input terminal [4] active state	UINT	RW	PDO	0 ~ 1	1
0x3037	0x38	CA-25	Input terminal [5] active state	UINT	RW	PDO	0 ~ 1	1
0x3037	0x39	CA-26	Input terminal [6] active state	UINT	RW	PDO	0 ~ 1	1
0x3037	0x3A	CA-27	Input terminal [7] active state	UINT	RW	PDO	0 ~ 1	1
0x3037	0x3B	CA-28	Input terminal [8] active state	UINT	RW	PDO	0 ~ 1	1
0x3037	0x3C	CA-29	Input terminal [9] active state	UINT	RW	PDO	0 ~ 1	1
0x3037	0x3D	CA-30	Input terminal [A] active state	UINT	RW	PDO	0 ~ 1	1
0x3037	0x3E	CA-31	Input terminal [B] active state	UINT	RW	PDO	0 ~ 1	1
0x3037	0x48	CA-41	Input terminal [1] response time	UINT	RW	PDO	0 ~ 400	1ms
0x3037	0x49	CA-42	Input terminal [2] response time	UINT	RW	PDO	0 ~ 400	1ms
0x3037	0x4A	CA-43	Input terminal [3] response time	UINT	RW	PDO	0 ~ 400	1ms
0x3037	0x4B	CA-44	Input terminal [4] response time	UINT	RW	PDO	0 ~ 400	1ms
0x3037	0x4C	CA-45	Input terminal [5] response time	UINT	RW	PDO	0 ~ 400	1ms
0x3037	0x4D	CA-46	Input terminal [6] response time	UINT	RW	PDO	0 ~ 400	1ms
0x3037	0x4E	CA-47	Input terminal [7] response time	UINT	RW	PDO	0 ~ 400	1ms

Index	Sub-index	Func code	Function name	Type	Access	PDO	Setting Items	Data resolution -units
0x3037	0x4F	CA-48	Input terminal [8] response time	UINT	RW	PDO	0 ~ 400	1ms
0x3037	0x50	CA-49	Input terminal [9] response time	UINT	RW	PDO	0 ~ 400	1ms
0x3037	0x51	CA-50	Input terminal [A] response time	UINT	RW	PDO	0 ~ 400	1ms
0x3037	0x52	CA-51	Input terminal [B] response time	UINT	RW	PDO	0 ~ 400	1ms
0x3037	0x56	CA-55	Multistage speed/position determination time	UINT	RW	PDO	0 ~ 2000	1ms
0x3037	0x5B	CA-60	FUP/FDN overwrite target selection	UINT	RW	PDO	0 ~ 1	1
0x3037	0x5C	CA-61	FUP/FDN data save enable	UINT	RW	PDO	0 ~ 1	1
0x3037	0x5D	CA-62	FUP/FDN UDC selection	UINT	RW	PDO	0 ~ 1	1
0x4037	0x5F	CA-64	Acceleration time setting for FUP/FDN function	UDINT	RW	PDO	0 ~ 360000	0.01s
0x4037	0x61	CA-66	Deceleration time setting for FUP/FDN function	UDINT	RW	PDO	0 ~ 360000	0.01s
0x3037	0x65	CA-70	Speed reference source selection at [F-OP] is active	UINT	RW	PDO	1 ~ 16	1
0x3037	0x66	CA-71	RUN command source selection at [F-OP] is active	UINT	RW	PDO	0 ~ 6	1
0x3037	0x67	CA-72	Reset mode selection	UINT	RW	TxPDO	0 ~ 3	1
0x3037	0x70	CA-81	Encoder constant setting	UINT	RW	TxPDO	32 ~ 65535	1pls
0x3037	0x71	CA-82	Encoder position selection	UINT	RW	TxPDO	0 ~ 1	1
0x3037	0x72	CA-83	Motor gear ratio Numerator	UINT	RW	TxPDO	1 ~ 10000	1
0x3037	0x73	CA-84	Motor gear ratio Denominator	UINT	RW	TxPDO	1 ~ 10000	1
0x3037	0x79	CA-90	Pulse train detection object selection	UINT	RW	TxPDO	0 ~ 3	1
0x3037	0x7A	CA-91	Mode selection of pulse train input	UINT	RW	TxPDO	0 ~ 2	1
0x3037	0x7B	CA-92	Pulse train frequency Scale	UINT	RW	PDO	5 ~ 3200	0.01kHz
0x3037	0x7C	CA-93	Pulse train frequency Filter time constant	UINT	RW	PDO	1 ~ 200	0.01s
0x3037	0x7D	CA-94	Pulse train frequency Bias value	INT	RW	PDO	-1000 ~ 1000	0.1%
0x3037	0x7E	CA-95	Pulse train frequency High Limit	UINT	RW	PDO	0 ~ 1000	0.1%

Index	Sub-index	Func code	Function name	Type	Access	PDO	Setting Items	Data resolution -units
0x3037	0x7F	CA-96	Pulse train frequency detection low level	UINT	RW	PDO	0 ~ 1000	0.1%
0x3037	0x80	CA-97	Comparing match output ON-level for Pulse count	UINT	RW	PDO	0 ~ 65535	1
0x3037	0x81	CA-98	Comparing match output OFF-level for Pulse count	UINT	RW	PDO	0 ~ 65535	1
0x3037	0x82	CA-99	Comparing match output Maximum value for Pulse count	UINT	RW	PDO	0 ~ 65535	1
0x3037	0x84	Cb-01	Filter time constant of Terminal Ai1	UINT	RW	PDO	1 ~ 500	1ms
0x3037	0x86	Cb-03	Start value of Terminal Ai1	UINT	RW	PDO	0 ~ 10000	0.01%
0x3037	0x87	Cb-04	End value of Terminal Ai1	UINT	RW	PDO	0 ~ 10000	0.01%
0x3037	0x88	Cb-05	Start rate of Terminal Ai1	UINT	RW	PDO	0 ~ 1000 (Cb-06)	0.1%
0x3037	0x89	Cb-06	End rate of Terminal Ai1	UINT	RW	PDO	(Cb-05) 0 ~ 1000	0.1%
0x3037	0x8A	Cb-07	Start point selection of Terminal Ai1	UINT	RW	PDO	0 ~ 1	1
0x3037	0x8E	Cb-11	Filter time constant of Terminal Ai2	UINT	RW	PDO	1 ~ 500	1ms
0x3037	0x90	Cb-13	Start value of Terminal Ai2	UINT	RW	PDO	0 ~ 10000	0.01%
0x3037	0x91	Cb-14	End value of Terminal Ai2	UINT	RW	PDO	0 ~ 10000	0.01%
0x3037	0x92	Cb-15	Start rate of Terminal Ai2	UINT	RW	PDO	0 ~ 1000 (Cb-16)	0.1%
0x3037	0x93	Cb-16	End rate of Terminal Ai2	UINT	RW	PDO	(Cb-15) 0 ~ 1000	0.1%
0x3037	0x94	Cb-17	Start point selection of Terminal Ai2	UINT	RW	PDO	0 ~ 1	1
0x3037	0x98	Cb-21	Filter time constant of Terminal Ai3	UINT	RW	PDO	1 ~ 500	1ms
0x3037	0x99	Cb-22	Terminal Ai3 selection	UINT	RW	TxPDO	0 ~ 2	1
0x3037	0x9A	Cb-23	Start value of Terminal Ai3	INT	RW	PDO	-10000 ~ 10000	0.01%
0x3037	0x9B	Cb-24	End value of Terminal Ai3	INT	RW	PDO	-10000 ~ 10000	0.01%
0x3037	0x9C	Cb-25	Start rate of Terminal Ai3	INT	RW	PDO	-1000 ~ 1000 (Cb-26)	0.1%
0x3037	0x9D	Cb-26	End rate of Terminal Ai3	INT	RW	PDO	(Cb-25)-1000 ~ 1000	0.1%
0x3037	0xA1	Cb-30	Ai1 Voltage/Current zero-gain adjustment	INT	RW	PDO	-10000 ~ 10000	0.01%

Index	Sub-index	Func code	Function name	Type	Access	PDO	Setting Items	Data resolution -units
0x3037	0xA2	Cb-31	Ai1 Voltage/Current gain adjustment	UINT	RW	PDO	0 ~ 20000	0.01%
0x3037	0xA3	Cb-32	Ai2 Voltage/Current zero-gain adjustment	INT	RW	PDO	-10000 ~ 10000	0.01%
0x3037	0xA4	Cb-33	Ai2 Voltage/Current gain adjustment	UINT	RW	PDO	0 ~ 20000	0.01%
0x3037	0xA5	Cb-34	Ai3 Voltage/Current zero-gain adjustment	INT	RW	PDO	-10000 ~ 10000	0.01%
0x3037	0xA6	Cb-35	Ai3 Voltage gain adjustment	UINT	RW	PDO	0 ~ 20000	0.01%
0x3037	0xAB	Cb-40	Thermistor selection	UINT	RW	PDO	0 ~ 2	1
0x3037	0xAC	Cb-41	Thermistor gain adjustment	UINT	RW	PDO	0 ~ 10000	0.1
0x3037	0xB6	Cb-51	Filter time constant of Volume on keypad	UINT	RW	PDO	1 ~ 500	1ms
0x3037	0xB8	Cb-53	Start value of Volume on keypad	UINT	RW	PDO	0 ~ 10000	0.01%
0x3037	0xB9	Cb-54	End value of Volume on keypad	UINT	RW	PDO	0 ~ 10000	0.01%
0x3037	0xBA	Cb-55	Start rate of Volume on keypad	UINT	RW	PDO	0 ~ 1000 (Cb-56)	0.1%
0x3037	0xBB	Cb-56	End rate of Volume on keypad	UINT	RW	PDO	(Cb-55) 0 ~ 1000	0.1%
0x3037	0xBC	Cb-57	Start point selection of Volume on keypad	UINT	RW	PDO	0 ~ 1	1
0x3037	0xE8	CC-01	Output terminal [11] function	UINT	RW	PDO	0 ~ 93	1
0x3037	0xE9	CC-02	Output terminal [12] function	UINT	RW	PDO	0 ~ 93	1
0x3037	0xEA	CC-03	Output terminal [13] function	UINT	RW	PDO	0 ~ 93	1
0x3037	0xEB	CC-04	Output terminal [14] function	UINT	RW	PDO	0 ~ 93	1
0x3037	0xEC	CC-05	Output terminal [15] function	UINT	RW	PDO	0 ~ 93	1
0x3037	0xED	CC-06	Relay output terminal [16] function	UINT	RW	PDO	0 ~ 93	1
0x3037	0xEE	CC-07	Relay output terminal [AL] function	UINT	RW	PDO	0 ~ 93	1
0x3037	0xF2	CC-11	Output terminal [11] active state	UINT	RW	PDO	0 ~ 1	1
0x3037	0xF3	CC-12	Output terminal [12] active state	UINT	RW	PDO	0 ~ 1	1
0x3037	0xF4	CC-13	Output terminal [13] active state	UINT	RW	PDO	0 ~ 1	1
0x3037	0xF5	CC-14	Output terminal [14] active state	UINT	RW	PDO	0 ~ 1	1

Index	Sub-index	Func code	Function name	Type	Access	PDO	Setting Items	Data resolution -units
0x3037	0xF6	CC-15	Output terminal [15] active state	UINT	RW	PDO	0 ~ 1	1
0x3037	0xF7	CC-16	Output terminal [16] active state	UINT	RW	PDO	0 ~ 1	1
0x3037	0xF8	CC-17	Output terminal [AL] active state	UINT	RW	PDO	0 ~ 1	1
0x3037	0xFB	CC-20	Output terminal [11] on-delay time	UINT	RW	PDO	0 ~ 10000	0.01s
0x3037	0xFC	CC-21	Output terminal [11] off-delay time	UINT	RW	PDO	0 ~ 10000	0.01s
0x3037	0xFD	CC-22	Output terminal [12] on-delay time	UINT	RW	PDO	0 ~ 10000	0.01s
0x3037	0xFE	CC-23	Output terminal [12] off-delay time	UINT	RW	PDO	0 ~ 10000	0.01s
0x3038	0x1	CC-24	Output terminal [13] on-delay time	UINT	RW	PDO	0 ~ 10000	0.01s
0x3038	0x2	CC-25	Output terminal [13] off-delay time	UINT	RW	PDO	0 ~ 10000	0.01s
0x3038	0x3	CC-26	Output terminal [14] on-delay time	UINT	RW	PDO	0 ~ 10000	0.01s
0x3038	0x4	CC-27	Output terminal [14] off-delay time	UINT	RW	PDO	0 ~ 10000	0.01s
0x3038	0x5	CC-28	Output terminal [15] on-delay time	UINT	RW	PDO	0 ~ 10000	0.01s
0x3038	0x6	CC-29	Output terminal [15] off-delay time	UINT	RW	PDO	0 ~ 10000	0.01s
0x3038	0x7	CC-30	Output relay [16] on-delay time	UINT	RW	PDO	0 ~ 10000	0.01s
0x3038	0x8	CC-31	Output relay [16] off-delay time	UINT	RW	PDO	0 ~ 10000	0.01s
0x3038	0x9	CC-32	Output relay [AL] on-delay time	UINT	RW	PDO	0 ~ 10000	0.01s
0x3038	0xA	CC-33	Output relay [AL] off-delay time	UINT	RW	PDO	0 ~ 10000	0.01s
0x3038	0x11	CC-40	Logical calculation target 1 selection of LOG1	UINT	RW	PDO	0 ~ 93	1
0x3038	0x12	CC-41	Logical calculation target 2 selection of LOG1	UINT	RW	PDO	0 ~ 93	1
0x3038	0x13	CC-42	Logical calculation symbol selection of LOG1	UINT	RW	PDO	0 ~ 2	1

Index	Sub-index	Func code	Function name	Type	Access	PDO	Setting Items	Data resolution -units
0x3038	0x14	CC-43	Logical calculation target 1 selection of LOG2	UINT	RW	PDO	0 ~ 93	1
0x3038	0x15	CC-44	Logical calculation target 2 selection of LOG2	UINT	RW	PDO	0 ~ 93	1
0x3038	0x16	CC-45	Logical calculation symbol selection of LOG2	UINT	RW	PDO	0 ~ 2	1
0x3038	0x17	CC-46	Logical calculation target 1 selection of LOG3	UINT	RW	PDO	0 ~ 93	1
0x3038	0x18	CC-47	Logical calculation target 2 selection of LOG3	UINT	RW	PDO	0 ~ 93	1
0x3038	0x19	CC-48	Logical calculation symbol selection of LOG3	UINT	RW	PDO	0 ~ 2	1
0x3038	0x1A	CC-49	Logical calculation target 1 selection of LOG4	UINT	RW	PDO	0 ~ 93	1
0x3038	0x1B	CC-50	Logical calculation target 2 selection of LOG4	UINT	RW	PDO	0 ~ 93	1
0x3038	0x1C	CC-51	Logical calculation symbol selection of LOG4	UINT	RW	PDO	0 ~ 2	1
0x3038	0x1D	CC-52	Logical calculation target 1 selection of LOG5	UINT	RW	PDO	0 ~ 93	1
0x3038	0x1E	CC-53	Logical calculation target 2 selection of LOG5	UINT	RW	PDO	0 ~ 93	1
0x3038	0x1F	CC-54	Logical calculation symbol selection of LOG5	UINT	RW	PDO	0 ~ 2	1
0x3038	0x20	CC-55	Logical calculation target 1 selection of LOG6	UINT	RW	PDO	0 ~ 93	1
0x3038	0x21	CC-56	Logical calculation target 2 selection of LOG6	UINT	RW	PDO	0 ~ 93	1
0x3038	0x22	CC-57	Logical calculation symbol selection of LOG6	UINT	RW	PDO	0 ~ 2	1

Index	Sub-index	Func code	Function name	Type	Access	PDO	Setting Items	Data resolution -units
0x3038	0x23	CC-58	Logical calculation target 1 selection of LOG7	UINT	RW	PDO	0 ~ 93	1
0x3038	0x24	CC-59	Logical calculation target 2 selection of LOG7	UINT	RW	PDO	0 ~ 93	1
0x3038	0x25	CC-60	Logical calculation symbol selection of LOG7	UINT	RW	PDO	0 ~ 2	1
0x3038	0x4E	Cd-01	FM monitor output wave form selection	UINT	RW	PDO	0 ~ 1	1
0x3038	0x4F	Cd-02	FM monitor output base frequency (at PWM output)	UINT	RW	PDO	0 ~ 3600	1Hz
0x3038	0x50	Cd-03	FM monitor output selection	UINT	RW	PDO	0 ~ 65535 (d,F-code register number)	1
0x3038	0x51	Cd-04	Ao1 monitor output selection	UINT	RW	PDO	0 ~ 65535 (d,F-code register number)	1
0x3038	0x52	Cd-05	Ao2 monitor output selection	UINT	RW	PDO	0 ~ 65535 (d,F-code register number)	1
0x3038	0x57	Cd-10	Analog monitor adjust mode enable	UINT	RW	TxPDO	0 ~ 1	1
0x3038	0x58	Cd-11	Filter time constant of FMmonitor	UINT	RW	PDO	1 ~ 500	1ms
0x3038	0x59	Cd-12	FM Data type selection	UINT	RW	PDO	0 ~ 1	1
0x3038	0x5A	Cd-13	FM monitor bias adjustment	INT	RW	PDO	-1000 ~ 1000	0.1%
0x3038	0x5B	Cd-14	FM monitor gain adjustment	INT	RW	PDO	-10000 ~ 10000	0.1%
0x3038	0x5C	Cd-15	Output level setting at FM monitor adjust mode	INT	RW	PDO	-1000 ~ 1000	0.1%
0x3038	0x62	Cd-21	Filter time constant of Ao1 monitor	UINT	RW	PDO	1 ~ 500	1ms
0x3038	0x63	Cd-22	Ao1 Data type selection	UINT	RW	PDO	0 ~ 1	1
0x3038	0x64	Cd-23	Ao1 monitor bias adjustment	INT	RW	PDO	-1000 ~ 1000	0.1%
0x3038	0x65	Cd-24	Ao1 monitor gain adjustment	INT	RW	PDO	-10000 ~ 10000	0.1%
0x3038	0x66	Cd-25	Output level setting at Ao1 monitor adjust mode	INT	RW	PDO	-1000 ~ 1000	0.1%
0x3038	0x6C	Cd-31	Filter time constant of Ao2 monitor	UINT	RW	PDO	1 ~ 500	1ms

Index	Sub-index	Func code	Function name	Type	Access	PDO	Setting Items	Data resolution -units
0x3038	0x6D	Cd-32	Ao2 Data type selection	UINT	RW	PDO	0 ~ 1	1
0x3038	0x6E	Cd-33	Ao2 monitor bias adjustment	INT	RW	PDO	-1000 ~ 1000	0.1%
0x3038	0x6F	Cd-34	Ao2 monitor gain adjustment	INT	RW	PDO	-10000 ~ 10000	0.1%
0x3038	0x70	Cd-35	Output level setting at Ao2 monitor adjust mode	INT	RW	PDO	-1000 ~ 1000	0.1%
0x3038	0xB2	CE101	Low current signal output mode selection, 1st motor	UINT	RW	PDO	0 ~ 1	1
0x3038	0xB3	CE102	Low current detection level 1, 1st motor	UINT	RW	PDO	(0~2.00)*CTL Rated current	0.1A
0x3038	0xB4	CE103	Low current detection level 2, 1st motor	UINT	RW	PDO	(0~2.00)*CTL Rated current	0.1A
0x3038	0xB6	CE105	Over current signal output mode selection, 1st motor	UINT	RW	PDO	0 ~ 1	1
0x3038	0xB7	CE106	Over current detection level 1, 1st motor	UINT	RW	PDO	(0~2.00)*CTL Rated current	0.1A
0x3038	0xB8	CE107	Over current detection level 2, 1st motor	UINT	RW	PDO	(0~2.00)*CTL Rated current	0.1A
0x3038	0xBB	CE-10	Arrival frequency setting during acceleration 1	UINT	RW	PDO	0 ~ 59000	0.01Hz
0x3038	0xBC	CE-11	Arrival frequency setting during deceleration 1	UINT	RW	PDO	0 ~ 59000	0.01Hz
0x3038	0xBD	CE-12	Arrival frequency setting during acceleration 2	UINT	RW	PDO	0 ~ 59000	0.01Hz
0x3038	0xBE	CE-13	Arrival frequency setting during deceleration 2	UINT	RW	PDO	0 ~ 59000	0.01Hz
0x3038	0xC5	CE120	Over torque level (Forward driving), 1st motor	UINT	RW	PDO	0 ~ 5000	0.1%
0x3038	0xC6	CE121	Over torque level (Reverse regenerative), 1st motor	UINT	RW	PDO	0 ~ 5000	0.1%
0x3038	0xC7	CE122	Over torque level (Reverse driving), 1st motor	UINT	RW	PDO	0 ~ 5000	0.1%

Index	Sub-index	Func code	Function name	Type	Access	PDO	Setting Items	Data resolution -units
0x3038	0xC8	CE123	Over torque level (Forward regenerative), 1st motor	UINT	RW	PDO	0 ~ 5000	0.1%
0x3038	0xCF	CE-30	Electronic thermal warning level (MTR)	UINT	RW	PDO	0 ~ 10000	0.01%
0x3038	0xD0	CE-31	Electronic thermal warning level (CTL)	UINT	RW	PDO	0 ~ 10000	0.01%
0x3038	0xD2	CE-33	Zero speed detection level	UINT	RW	PDO	0 ~ 10000	0.01Hz
0x3038	0xD3	CE-34	Cooling FAN over-heat warning level	UINT	RW	PDO	0 ~ 200	1°C
0x4038	0xD5	CE-36	Accum. RUN (RNT)/Accum. Power-on (ONT) time setting	UDINT	RW	PDO	0 ~ 100000	1hr
0x3038	0xD9	CE-40	Window compareter for Ai1 higher level	UINT	RW	PDO	0 ~ 100	1%
0x3038	0xDA	CE-41	Window compareter for Ai1 lower level	UINT	RW	PDO	0 ~ 100	1%
0x3038	0xDB	CE-42	Window compareter for Ai1 hysteresis width	UINT	RW	PDO	0 ~ 10	1%
0x3038	0xDC	CE-43	Window compareter for Ai2 higher level	UINT	RW	PDO	0 ~ 100	1%
0x3038	0xDD	CE-44	Window compareter for Ai2 lower level	UINT	RW	PDO	0 ~ 100	1%
0x3038	0xDE	CE-45	Window compareter for Ai2 hysteresis width	UINT	RW	PDO	0 ~ 10	1%
0x3038	0xDF	CE-46	Window compareter for Ai3 higher level	INT	RW	PDO	-100 ~ 100	1%
0x3038	0xE0	CE-47	Window compareter for Ai3 lower level	INT	RW	PDO	-100 ~ 100	1%
0x3038	0xE1	CE-48	Window compareter for Ai3 hysteresis width	UINT	RW	PDO	0 ~ 10	1%
0x3038	0xE3	CE-50	Operation level at Ai1 disconnection	UINT	RW	PDO	0 ~ 100	1%
0x3038	0xE4	CE-51	Operation level selection at Ai1 disconnection	UINT	RW	PDO	0 ~ 2	1
0x3038	0xE5	CE-52	Operation level at Ai2 disconnection	UINT	RW	PDO	0 ~ 100	1%

Index	Sub-index	Func code	Function name	Type	Access	PDO	Setting Items	Data resolution -units
0x3038	0xE6	CE-53	Operation level selection at Ai2 disconnection	UINT	RW	PDO	0 ~ 2	1
0x3038	0xE7	CE-54	Operation level at Ai3 disconnection	INT	RW	PDO	-100 ~ 100	1%
0x3038	0xE8	CE-55	Operation level selection at Ai3 disconnection	UINT	RW	PDO	0 ~ 2	1
0x3060	0x12	CE201	Low current signal output mode selection, 2nd-motor	UINT	RW	PDO	0 ~ 1	1
0x3060	0x13	CE202	Low current detection level 1, 2nd-motor	UINT	RW	PDO	(0-2.00)*CTL Rated current	0.1A
0x3060	0x14	CE203	Low current detection level 2, 2nd-motor	UINT	RW	PDO	(0-2.00)*CTL Rated current	0.1A
0x3060	0x16	CE205	Over current signal output mode selection, 2nd-motor	UINT	RW	PDO	0 ~ 1	1
0x3060	0x17	CE206	Over current detection level 1, 2nd-motor	UINT	RW	PDO	(0-2.00)*CTL Rated current	0.1A
0x3060	0x18	CE207	Over current detection level 2, 2nd-motor	UINT	RW	PDO	(0-2.00)*CTL Rated current	0.1A
0x3060	0x25	CE220	Over torque level (Forward driving), 2nd-motor	UINT	RW	PDO	0 ~ 5000	0.1%
0x3060	0x26	CE221	Over torque level (Reverse regenerative), 2nd-motor	UINT	RW	PDO	0 ~ 5000	0.1%
0x3060	0x27	CE222	Over torque level (Reverse driving), 2nd-motor	UINT	RW	PDO	0 ~ 5000	0.1%
0x3060	0x28	CE223	Over torque level (Forward regenerative), 2nd motor	UINT	RW	PDO	0 ~ 5000	0.1%
0x3039	0x18	CF-01	RS485 communication baud rate selection	UINT	RW	PDO	3 ~ 10	1
0x3039	0x19	CF-02	RS485 communication Node allocation	UINT	RW	PDO	1 ~ 247	1
0x3039	0x1A	CF-03	RS485 communication parity selection	UINT	RW	PDO	0 ~ 2	1
0x3039	0x1B	CF-04	RS485 communication stop-bit selection	UINT	RW	PDO	1 ~ 2	1

Index	Sub-index	Func code	Function name	Type	Access	PDO	Setting Items	Data resolution -units
0x3039	0x1C	CF-05	RS485 communication error selection	UINT	RW	PDO	0 ~ 4	1
0x3039	0x1D	CF-06	RS485 communication timeout setting	UINT	RW	PDO	0 ~ 10000	0.01s
0x3039	0x1E	CF-07	RS485 communication wait time setting	UINT	RW	PDO	0 ~ 1000	1ms
0x3039	0x1F	CF-08	RS485 communication mode selection	UINT	RW	PDO	1 ~ 3	1
0x3039	0x22	CF-11	Register data AVI ↔ % conversion function	UINT	RW	TxPDO	0 ~ 1	1
0x3039	0x2B	CF-20	EzCOM Start node No.	UINT	RW	TxPDO	1 ~ 8	1
0x3039	0x2C	CF-21	EzCOM End node No.	UINT	RW	TxPDO	1 ~ 8	1
0x3039	0x2D	CF-22	EzCOM Start method selection	UINT	RW	TxPDO	0 ~ 1	1
0x3039	0x2E	CF-23	EzCOM data size	UINT	RW	PDO	1 ~ 5	1
0x3039	0x2F	CF-24	EzCOM destination address 1	UINT	RW	PDO	1 ~ 247	1
0x3039	0x30	CF-25	EzCOM destination register 1	UINT	RW	PDO	0 ~ 65535	1
0x3039	0x31	CF-26	EzCOM source register 1	UINT	RW	PDO	0 ~ 65535	1
0x3039	0x32	CF-27	EzCOM destination address 2	UINT	RW	PDO	1 ~ 247	1
0x3039	0x33	CF-28	EzCOM destination register 2	UINT	RW	PDO	0 ~ 65535	1
0x3039	0x34	CF-29	EzCOM source register 2	UINT	RW	PDO	0 ~ 65535	1
0x3039	0x35	CF-30	EzCOM destination address 3	UINT	RW	PDO	1 ~ 247	1
0x3039	0x36	CF-31	EzCOM destination register 3	UINT	RW	PDO	0 ~ 65535	1
0x3039	0x37	CF-32	EzCOM source register 3	UINT	RW	PDO	0 ~ 65535	1
0x3039	0x38	CF-33	EzCOM destination address 4	UINT	RW	PDO	1 ~ 247	1
0x3039	0x39	CF-34	EzCOM destination register 4	UINT	RW	PDO	0 ~ 65535	1
0x3039	0x3A	CF-35	EzCOM source register 4	UINT	RW	PDO	0 ~ 65535	1
0x3039	0x3B	CF-36	EzCOM destination address 5	UINT	RW	PDO	1 ~ 247	1

Index	Sub-index	Func code	Function name	Type	Access	PDO	Setting Items	Data resolution ·units
0x3039	0x3C	CF-37	EzCOM destination register 5	UINT	RW	PDO	0 ~ 65535	1
0x3039	0x3D	CF-38	EzCOM source register 5	UINT	RW	PDO	0 ~ 65535	1
0x3039	0x49	CF-50	USB communication Node allocation	UINT	RW	TxPDO	1 ~ 247	1

13.2.6 Code-H

Index	Sub-index	Func code	Function name	Type	Access	PDO	Setting Items	Data resolution ·units
0x303B	0x10	HA-01	Auto-tuning selection	UINT	RW	TxPDO	0 ~ 3	1
0x303B	0x11	HA-02	RUN command selection at Auto-tuning	UINT	RW	TxPDO	0 ~ 1	1
0x303B	0x12	HA-03	Online auto-tuning selection	UINT	RW	TxPDO	0 ~ 1	1
0x303B	0x19	HA110	Stabilization constant, 1st-motor	UINT	RW	PDO	0 ~ 1000	1%
0x303B	0x1E	HA115	Speed response, 1st-motor	UINT	RW	PDO	0 ~ 1000	1%
0x303B	0x23	HA120	ASR gain switching mode selection, 1st-motor	UINT	RW	PDO	0 ~ 1	1
0x303B	0x24	HA121	ASR gain switching time setting, 1st-motor	UINT	RW	PDO	0 ~ 10000	1ms
0x303B	0x25	HA122	ASR gain mapping intermediate speed 1, 1st-motor	UINT	RW	PDO	0 ~ 59000	0.01Hz
0x303B	0x26	HA123	ASR gain mapping intermediate speed 2, 1st-motor	UINT	RW	PDO	0 ~ 59000	0.01Hz
0x303B	0x27	HA124	ASR gain mapping Maximum speed, 1st-motor	UINT	RW	PDO	0 ~ 59000	0.01Hz
0x303B	0x28	HA125	ASR gain mapping P-gain 1, 1st-motor	UINT	RW	PDO	0 ~ 10000	0.1%
0x303B	0x29	HA126	ASR gain mapping I-gain 1, 1st-motor	UINT	RW	PDO	0 ~ 10000	0.1%
0x303B	0x2A	HA127	ASR gain mapping P-gain 1 at P-control, 1st-motor	UINT	RW	PDO	0 ~ 10000	0.1%

Index	Sub-index	Func code	Function name	Type	Access	PDO	Setting Items	Data resolution -units
0x303B	0x2B	HA128	ASR gain mapping P-gain 2, 1st-motor	UINT	RW	PDO	0 ~ 10000	0.1%
0x303B	0x2C	HA129	ASR gain mapping I-gain 2, 1st-motor	UINT	RW	PDO	0 ~ 10000	0.1%
0x303B	0x2D	HA130	ASR gain mapping P-gain 2 at P-control, 1st-motor	UINT	RW	PDO	0 ~ 10000	0.1%
0x303B	0x2E	HA131	ASR gain mapping P-gain 3, 1st-motor	UINT	RW	PDO	0 ~ 10000	0.1%
0x303B	0x2F	HA132	ASR gain mapping I-gain 3, 1st-motor	UINT	RW	PDO	0 ~ 10000	0.1%
0x303B	0x30	HA133	ASR gain mapping P-gain 4, 1st-motor	UINT	RW	PDO	0 ~ 10000	0.1%
0x303B	0x31	HA134	ASR gain mapping I-gain 4, 1st-motor	UINT	RW	PDO	0 ~ 10000	0.1%
0x3062	0x77	HA210	Stabilization constant, 2nd-motor	UINT	RW	PDO	0 ~ 1000	1%
0x3062	0x7C	HA215	Speed response, 2nd-motor	UINT	RW	PDO	0 ~ 1000	1%
0x3062	0x81	HA220	ASR gain switching mode selection, 2nd-motor	UINT	RW	PDO	0 ~ 1	1
0x3062	0x82	HA221	ASR gain switching time setting, 2nd-motor	UINT	RW	PDO	0 ~ 10000	1ms
0x3062	0x83	HA222	ASR gain mapping intermediate speed 1, 2nd-motor	UINT	RW	PDO	0 ~ 59000	0.01Hz
0x3062	0x84	HA223	ASR gain mapping intermediate speed 2, 2nd-motor	UINT	RW	PDO	0 ~ 59000	0.01Hz
0x3062	0x85	HA224	ASR gain mapping Maximum speed, 2nd-motor	UINT	RW	PDO	0 ~ 59000	0.01Hz
0x3062	0x86	HA225	ASR gain mapping P-gain 1, 2nd-motor	UINT	RW	PDO	0 ~ 10000	0.1%
0x3062	0x87	HA226	ASR gain mapping I-gain 1, 2nd-motor	UINT	RW	PDO	0 ~ 10000	0.1%
0x3062	0x88	HA227	ASR gain mapping P-gain 1 at P-control, 2nd-motor	UINT	RW	PDO	0 ~ 10000	0.1%
0x3062	0x89	HA228	ASR gain mapping P-gain 2, 2nd-motor	UINT	RW	PDO	0 ~ 10000	0.1%

Index	Sub-index	Func code	Function name	Type	Access	PDO	Setting Items	Data resolution -units
0x3062	0x8A	HA229	ASR gain mapping I-gain 2, 2nd-motor	UINT	RW	PDO	0 ~ 10000	0.1%
0x3062	0x8B	HA230	ASR gain mapping P-gain 2 at P-control, 2nd-motor	UINT	RW	PDO	0 ~ 10000	0.1%
0x3062	0x8C	HA231	ASR gain mapping P-gain 3, 2nd-motor	UINT	RW	PDO	0 ~ 10000	0.1%
0x3062	0x8D	HA232	ASR gain mapping I-gain 3, 2nd-motor	UINT	RW	PDO	0 ~ 10000	0.1%
0x3062	0x8E	HA233	ASR gain mapping P-gain 4, 2nd-motor	UINT	RW	PDO	0 ~ 10000	0.1%
0x3062	0x8F	HA234	ASR gain mapping I-gain 4, 2nd-motor	UINT	RW	PDO	0 ~ 10000	0.1%
0x303B	0x75	Hb102	Async. Motor capacity setting, 1st-motor	UINT	RW	TxPDO	1 ~ 16000	0.01kW
0x303B	0x76	Hb103	Async. Motor Pole number setting, 1st-motor	UINT	RW	TxPDO	0 ~ 23	1
0x303B	0x77	Hb104	Async. Motor Base frequency setting, 1st-motor	UINT	RW	TxPDO	1000 ~ 59000	0.01Hz
0x303B	0x78	Hb105	Async. Motor Maximum frequency setting, 1st-motor	UINT	RW	TxPDO	1000 ~ 59000	0.01Hz
0x303B	0x79	Hb106	Async. Motor rated voltage, 1st-motor	UINT	RW	TxPDO	1 ~ 1000	1V
0x403B	0x7B	Hb108	Async. Motor rated current, 1st-motor	UDINT	RW	TxPDO	1 ~ 1000000	0.01A
0x403B	0x7D	Hb110	Async. Motor constant R1, 1st-motor	UDINT	RW	TxPDO	1 ~ 1000000000	0.000001Ω
0x403B	0x7F	Hb112	Async. Motor constant R2, 1st-motor	UDINT	RW	TxPDO	1 ~ 1000000000	0.000001Ω
0x403B	0x81	Hb114	Async. Motor constant L, 1st-motor	UDINT	RW	TxPDO	1 ~ 1000000000	0.000001mH
0x403B	0x83	Hb116	Async. Motor constant Io, 1st-motor	UDINT	RW	TxPDO	1 ~ 1000000	0.01A
0x403B	0x85	Hb118	Async. Motor constant J, 1st-motor	UDINT	RW	TxPDO	1 ~ 1000000000	0.00001kg· m ²
0x303B	0x91	Hb130	Minimum frequency adjustment, 1st-motor	UINT	RW	TxPDO	10 ~ 1000	0.01Hz

Index	Sub-index	Func code	Function name	Type	Access	PDO	Setting Items	Data resolution -units
0x303B	0x92	Hb131	Reduced voltage start time setting, 1st-motor	UINT	RW	PDO	0 ~ 2000	1ms
0x303B	0x9B	Hb140	Manual torque boost operational mode selection, 1st-motor	UINT	RW	TxPDO	0 ~ 3	1
0x303B	0x9C	Hb141	Manual torque boost value, 1st-motor	UINT	RW	PDO	0 ~ 200	0.1%
0x303B	0x9D	Hb142	Manual torque boost Peak speed, 1st-motor	UINT	RW	PDO	0 ~ 500	0.1%
0x303B	0xA0	Hb145	Eco drive enable, 1st-motor	UINT	RW	TxPDO	0 ~ 1	1
0x303B	0xA1	Hb146	Eco drive response adjustment, 1st-motor	UINT	RW	PDO	0 ~ 100	1%
0x303B	0xA5	Hb150	Free-V/f frequency 1 setting, 1st-motor	UINT	RW	TxPDO	0 ~ 59000 (Hb152)	0.01Hz
0x303B	0xA6	Hb151	Free-V/f Voltage 1 setting, 1st-motor	UINT	RW	TxPDO	0 ~ 10000	0.1V
0x303B	0xA7	Hb152	Free-V/f frequency 2 setting, 1st-motor	UINT	RW	TxPDO	0 ~ 59000 (Hb150) ~ (Hb154)	0.01Hz
0x303B	0xA8	Hb153	Free-V/f Voltage 2 setting, 1st-motor	UINT	RW	TxPDO	0 ~ 10000	0.1V
0x303B	0xA9	Hb154	Free-V/f frequency 3 setting, 1st-motor	UINT	RW	TxPDO	0 ~ 59000 (Hb152) ~ (Hb156)	0.01Hz
0x303B	0xAA	Hb155	Free-V/f Voltage 3 setting, 1st-motor	UINT	RW	TxPDO	0 ~ 10000	0.1V
0x303B	0xAB	Hb156	Free-V/f frequency 4 setting, 1st-motor	UINT	RW	TxPDO	0 ~ 59000 (Hb154) ~ (Hb158)	0.01Hz
0x303B	0xAC	Hb157	Free-V/f Voltage 4 setting, 1st-motor	UINT	RW	TxPDO	0 ~ 10000	0.1V
0x303B	0xAD	Hb158	Free-V/f frequency 5 setting, 1st-motor	UINT	RW	TxPDO	0 ~ 59000 (Hb156) ~ (Hb160)	0.01Hz
0x303B	0xAE	Hb159	Free-V/f Voltage 5 setting, 1st-motor	UINT	RW	TxPDO	0 ~ 10000	0.1V
0x303B	0xAF	Hb160	Free-V/f frequency 6 setting, 1st-motor	UINT	RW	TxPDO	0 ~ 59000 (Hb158) ~ (Hb162)	0.01Hz

Index	Sub-index	Func code	Function name	Type	Access	PDO	Setting Items	Data resolution -units
0x303B	0xB0	Hb161	Free-V/f Voltage 6 setting, 1st-motor	UINT	RW	TxPDO	0 ~ 10000	0.1V
0x303B	0xB1	Hb162	Free-V/f frequency 7 setting, 1st-motor	UINT	RW	TxPDO	0 ~ 59000 (Hb160) ~ (Hb104)	0.01Hz
0x303B	0xB2	Hb163	Free-V/f Voltage 7 setting, 1st-motor	UINT	RW	TxPDO	0 ~ 10000	0.1V
0x303B	0xB9	Hb170	Slip Compensation P-gain with encoder, 1st-motor	UINT	RW	PDO	0 ~ 1000	1%
0x303B	0xBA	Hb171	Slip Compensation I-gain with encoder, 1st-motor	UINT	RW	PDO	0 ~ 1000	1%
0x303B	0xC3	Hb180	Output voltage gain, 1st-motor	UINT	RW	PDO	0 ~ 255	1%
0x3062	0xD3	Hb202	Async. Motor capacity setting, 2nd-motor	UINT	RW	TxPDO	1 ~ 16000	0.01kW
0x3062	0xD4	Hb203	Async. Motor Pole number setting, 2nd-motor	UINT	RW	TxPDO	0 ~ 23	1
0x3062	0xD5	Hb204	Async. Motor Base frequency setting, 2nd-motor	UINT	RW	TxPDO	1000 ~ 59000	0.01Hz
0x3062	0xD6	Hb205	Async. Motor Maximum frequency setting, 2nd-motor	UINT	RW	TxPDO	1000 ~ 59000	0.01Hz
0x3062	0xD7	Hb206	Async. Motor rated voltage, 2nd-motor	UINT	RW	TxPDO	1 ~ 1000	1V
0x4062	0xD9	Hb208	Async. Motor rated current, 2nd-motor	UDINT	RW	TxPDO	1 ~ 1000000	0.01A
0x4062	0xDB	Hb210	Async. Motor constant R1, 2nd-motor	UDINT	RW	TxPDO	1 ~ 1000000000	0.000001Ω
0x4062	0xDD	Hb212	Async. Motor constant R2, 2nd-motor	UDINT	RW	TxPDO	1 ~ 1000000000	0.000001Ω
0x4062	0xDF	Hb214	Async. Motor constant L, 2nd-motor	UDINT	RW	TxPDO	1 ~ 1000000000	0.000001mH
0x4062	0xE1	Hb216	Async. Motor constant I _o , 2nd-motor	UDINT	RW	TxPDO	1 ~ 1000000	0.01A
0x4062	0xE3	Hb218	Async. Motor constant J, 2nd-motor	UDINT	RW	TxPDO	1 ~ 1000000000	0.00001kg· m ²

Index	Sub-index	Func code	Function name	Type	Access	PDO	Setting Items	Data resolution -units
0x3062	0xEF	Hb230	Minimum frequency adjustment, 2nd-motor	UINT	RW	TxPDO	10 ~ 1000	0.01Hz
0x3062	0xF0	Hb231	Reduced voltage start time setting, 2nd-motor	UINT	RW	PDO	0 ~ 2000	1ms
0x3062	0xF9	Hb240	Manual torque boost operational mode selection, 2nd-motor	UINT	RW	TxPDO	0 ~ 3	1
0x3062	0xFA	Hb241	Manual torque boost value, 2nd-motor	UINT	RW	PDO	0 ~ 200	0.1%
0x3062	0xFB	Hb242	Manual torque boost Peak speed, 2nd-motor	UINT	RW	PDO	0 ~ 500	0.1%
0x3062	0xFE	Hb245	Eco drive enable, 2nd-motor	UINT	RW	TxPDO	0 ~ 1	1
0x3063	0x1	Hb246	Eco drive response adjustment, 2nd-motor	UINT	RW	PDO	0 ~ 100	1%
0x3063	0x5	Hb250	Free-V/f frequency 1 setting, 2nd-motor	UINT	RW	TxPDO	0 ~ 59000 (Hb252)	0.01Hz
0x3063	0x6	Hb251	Free-V/f Voltage 1 setting, 2nd-motor	UINT	RW	TxPDO	0 ~ 10000	0.1V
0x3063	0x7	Hb252	Free-V/f frequency 2 setting, 2nd-motor	UINT	RW	TxPDO	0 ~ 59000 (Hb250) ~ (Hb254)	0.01Hz
0x3063	0x8	Hb253	Free-V/f Voltage 2 setting, 2nd-motor	UINT	RW	TxPDO	0 ~ 10000	0.1V
0x3063	0x9	Hb254	Free-V/f frequency 3 setting, 2nd-motor	UINT	RW	TxPDO	0 ~ 59000 (Hb252) ~ (Hb256)	0.01Hz
0x3063	0xA	Hb255	Free-V/f Voltage 3 setting, 2nd-motor	UINT	RW	TxPDO	0 ~ 10000	0.1V
0x3063	0xB	Hb256	Free-V/f frequency 4 setting, 2nd-motor	UINT	RW	TxPDO	0 ~ 59000 (Hb254) ~ (Hb258)	0.01Hz
0x3063	0xC	Hb257	Free-V/f Voltage 4 setting, 2nd-motor	UINT	RW	TxPDO	0 ~ 10000	0.1V
0x3063	0xD	Hb258	Free-V/f frequency 5 setting, 2nd-motor	UINT	RW	TxPDO	0 ~ 59000 (Hb256) ~ (Hb260)	0.01Hz
0x3063	0xE	Hb259	Free-V/f Voltage 5 setting, 2nd-motor	UINT	RW	TxPDO	0 ~ 10000	0.1V

Index	Sub-index	Func code	Function name	Type	Access	PDO	Setting Items	Data resolution -units
0x3063	0xF	Hb260	Free-V/f frequency 6 setting, 2nd-motor	UINT	RW	TxPDO	0 ~ 59000 (Hb258) ~ (Hb262)	0.01Hz
0x3063	0x10	Hb261	Free-V/f Voltage 6 setting, 2nd-motor	UINT	RW	TxPDO	0 ~ 10000	0.1V
0x3063	0x11	Hb262	Free-V/f frequency 7 setting, 2nd-motor	UINT	RW	TxPDO	0 ~ 59000 (Hb260) ~ (Hb204)	0.01Hz
0x3063	0x12	Hb263	Free-V/f Voltage 7 setting, 2nd-motor	UINT	RW	TxPDO	0 ~ 10000	0.1V
0x3063	0x19	Hb270	Slip Compensation P-gain with encoder, 2nd-motor	UINT	RW	PDO	0 ~ 1000	1%
0x3063	0x1A	Hb271	Slip Compensation I-gain with encoder, 2nd-motor	UINT	RW	PDO	0 ~ 1000	1%
0x3063	0x23	Hb280	Output voltage gain, 2nd-motor	UINT	RW	PDO	0 ~ 255	1%
0x303B	0xD8	HC101	Automatic torque boost voltage compensation gain, 1st-motor	UINT	RW	PDO	0 ~ 255	1%
0x303B	0xD9	HC102	Automatic torque boost slip compensation gain, 1st-motor	UINT	RW	PDO	0 ~ 255	1%
0x303B	0xE1	HC110	Zero speed area limit for Async. M-OSLV, 1st-motor	UINT	RW	PDO	0 ~ 100	1%
0x303B	0xE2	HC111	Boost value at start, 1st-motor	UINT	RW	PDO	0 ~ 50	1%
0x303B	0xE3	HC112	Boost value at start for Async. M-OSLV, 1st-motor	UINT	RW	PDO	0 ~ 50	1%
0x303B	0xE4	HC113	Secondary resistance correction, 1st-motor	UINT	RW	TxPDO	0 ~ 1	1
0x303B	0xE5	HC114	Counter direction run protection selection, 1st-motor	UINT	RW	PDO	0 ~ 1	1
0x303B	0xEB	HC120	Torque current reference filter time constant, 1st-motor	UINT	RW	PDO	0 ~ 100	1ms
0x303B	0xEC	HC121	Speed feedforward compensation gain, 1st-motor	UINT	RW	PDO	0 ~ 1000	1%

Index	Sub-index	Func code	Function name	Type	Access	PDO	Setting Items	Data resolution -units
0x3063	0x38	HC201	Automatic torque boost voltage compensation gain, 2nd-motor	UINT	RW	PDO	0 ~ 255	1%
0x3063	0x39	HC202	Automatic torque boost slip compensation gain, 2nd-motor	UINT	RW	PDO	0 ~ 255	1%
0x3063	0x41	HC210	Zero speed area limit for Async.M-OSLV, 2nd-motor	UINT	RW	PDO	0 ~ 100	1%
0x3063	0x42	HC211	Boost value at start, 2nd-motor	UINT	RW	PDO	0 ~ 50	1%
0x3063	0x43	HC212	Boost value at start for Async.M-OSLV, 2nd-motor	UINT	RW	PDO	0 ~ 50	1%
0x3063	0x44	HC213	Secondary resistance correction, 2nd-motor	UINT	RW	TxPDO	0 ~ 1	1
0x3063	0x45	HC214	Counter direction run protection selection, 2nd-motor	UINT	RW	PDO	0 ~ 1	1
0x3063	0x4B	HC220	Torque current reference filter time constant, 2nd-motor	UINT	RW	PDO	0 ~ 100	1ms
0x3063	0x4C	HC221	Speed feedforward compensation gain, 2nd-motor	UINT	RW	PDO	0 ~ 1000	1%
0x303C	0x3F	Hd102	Sync. Motor capacity setting, 1st-motor	UINT	RW	TxPDO	1 ~ 16000	0.01kW
0x303C	0x40	Hd103	Sync. Motor Pole number setting, 1st-motor	UINT	RW	TxPDO	0 ~ 23	1
0x303C	0x41	Hd104	Sync. Base frequency setting, 1st-motor	UINT	RW	TxPDO	1000 ~ 59000	0.01Hz
0x303C	0x42	Hd105	Sync. Maximum frequency setting, 1st-motor	UINT	RW	TxPDO	1000 ~ 59000	0.01Hz
0x303C	0x43	Hd106	Sync. Motor rated voltage, 1st-motor	UINT	RW	TxPDO	1 ~ 1000	1V
0x403C	0x45	Hd108	Sync. Motor rated current, 1st-motor	UDINT	RW	TxPDO	1 ~ 1000000	0.01A
0x403C	0x47	Hd110	Sync. Motor constant R, 1st-motor	UDINT	RW	TxPDO	1 ~ 1000000000	0.000001Ω

Index	Sub-index	Func code	Function name	Type	Access	PDO	Setting Items	Data resolution -units
0x403C	0x49	Hd112	Sync. Motor constant Ld, 1st-motor	UDINT	RW	TxPDO	1 ~ 1000000000	0.000001mH
0x403C	0x4B	Hd114	Sync. Motor constant Lq, 1st-motor	UDINT	RW	TxPDO	1 ~ 1000000000	0.000001mH
0x403C	0x4D	Hd116	Sync. Motor constant Ke, 1st-motor	UDINT	RW	TxPDO	1 ~ 1000000	0.1mVs/rad
0x403C	0x4F	Hd118	Sync. Motor constant J, 1st-motor	UDINT	RW	TxPDO	1 ~ 1000000000	0.00001 kg·m ²
0x303C	0x5B	Hd130	Minimum Frequency for Sync. M-SLV, 1st-motor	UINT	RW	PDO	0 ~ 50	1%
0x303C	0x5C	Hd131	No-Load current for Sync. M-SLV, 1st-motor	UINT	RW	PDO	0 ~ 100	1%
0x303C	0x5D	Hd132	Starting Method for Sync. M, 1st-motor	UINT	RW	TxPDO	0 ~ 1	1
0x303C	0x5E	Hd133	IMPE OV wait number for Sync. M, 1st-motor	UINT	RW	TxPDO	0 ~ 255	1
0x303C	0x5F	Hd134	IMPE detect wait number for Sync. M, 1st-motor	UINT	RW	TxPDO	0 ~ 255	1
0x303C	0x60	Hd135	IMPE detect number for Sync. M, 1st-motor	UINT	RW	TxPDO	0 ~ 255	1
0x303C	0x61	Hd136	IMPE voltage gain for Sync. M, 1st-motor	UINT	RW	TxPDO	0 ~ 200	1%
0x303C	0x62	Hd137	IMPE Mg-pole position offset, 1st-motor	UINT	RW	TxPDO	0 ~ 359	1deg
0x303C	0x66	Hd-41	Carrier frequency at IVMS	UINT	RW	PDO	5 ~ 160	0.1kHz
0x303C	0x67	Hd-42	Filter gain of current detection at IVMS	UINT	RW	PDO	0 ~ 1000	1
0x303C	0x68	Hd-43	Open phase voltage detection gain, 1st-motor	UINT	RW	TxPDO	0 ~ 3	1
0x303C	0x69	Hd-44	Open phase switching threshold compensation	UINT	RW	PDO	0 ~ 1	1
0x303C	0x6A	Hd-45	P-Gain for speed control, SM (PMM)-IVMS	UINT	RW	PDO	0 ~ 1000	1
0x303C	0x6B	Hd-46	I-Gain for speed control, SM (PMM)-IVMS	UINT	RW	PDO	0 ~ 10000	1

Index	Sub-index	Func code	Function name	Type	Access	PDO	Setting Items	Data resolution -units
0x303C	0x6C	Hd-47	Wait time for open phase switching, SM (PMM)-IVMS	UINT	RW	PDO	0 ~ 1000	1
0x303C	0x6D	Hd-48	Limitation of decision about the drive direction, SM (PMM)-IVMS	UINT	RW	PDO	0 ~ 1	1
0x303C	0x6E	Hd-49	Open phase voltage detection timing adjustment, SM (PMM)-IVMS	UINT	RW	PDO	0 ~ 1000	1
0x303C	0x6F	Hd-50	Minimum pulse width adjustment, SM (PMM)-IVMS	UINT	RW	PDO	0 ~ 1000	1
0x303C	0x70	Hd-51	IVMS Current Limit	UINT	RW	PDO	0 ~ 255	1
0x303C	0x71	Hd-52	IVMS Threshold Gain	UINT	RW	PDO	0 ~ 255	1
0x303C	0x77	Hd-58	IVMSfc start/end point	UINT	RW	PDO	0 ~ 50	1%
0x3063	0x9D	Hd202	Sync. Motor capacity setting, 2nd-motor	UINT	RW	TxPDO	1 ~ 16000	0.01kW
0x3063	0x9E	Hd203	Sync. Motor Pole number setting, 2nd-motor	UINT	RW	TxPDO	0 ~ 23	1
0x3063	0x9F	Hd204	Sync. Base frequency setting, 2nd-motor	UINT	RW	TxPDO	1000 ~ 59000	0.01Hz
0x3063	0xA0	Hd205	Sync. Maximum frequency setting, 2nd-motor	UINT	RW	TxPDO	1000 ~ 59000	0.01Hz
0x3063	0xA1	Hd206	Sync. Motor rated voltage, 2nd-motor	UINT	RW	TxPDO	1 ~ 1000	1V
0x4063	0xA3	Hd208	Sync. Motor rated current, 2nd-motor	UDINT	RW	TxPDO	1 ~ 1000000	0.01A
0x4063	0xA5	Hd210	Sync. Motor constant R, 2nd-motor	UDINT	RW	TxPDO	1 ~ 1000000000	0.000001Ω
0x4063	0xA7	Hd212	Sync. Motor constant Ld, 2nd-motor	UDINT	RW	TxPDO	1 ~ 1000000000	0.000001mH
0x4063	0xA9	Hd214	Sync. Motor constant Lq, 2nd-motor	UDINT	RW	TxPDO	1 ~ 1000000000	0.000001mH
0x4063	0xAB	Hd216	Sync. Motor constant Ke, 2nd-motor	UDINT	RW	TxPDO	1 ~ 1000000	0.1mVs/rad
0x4063	0xAD	Hd218	Sync. Motor constant J, 2nd-motor	UDINT	RW	TxPDO	1 ~ 1000000000	0.00001 kg·m ²

Index	Sub-index	Func code	Function name	Type	Access	PDO	Setting Items	Data resolution -units
0x3063	0xB9	Hd230	Minimum Frequency for Sync. M-SLV, 2nd-motor	UINT	RW	PDO	0 ~ 50	1%
0x3063	0xBA	Hd231	No-Load current for Sync. M-SLV, 2nd-motor	UINT	RW	PDO	0 ~ 100	1%
0x3063	0xBB	Hd232	Starting Method for Sync. M, 2nd-motor	UINT	RW	TxPDO	0 ~ 1	1
0x3063	0xBC	Hd233	IMPE OV wait number for Sync. M, 2nd-motor	UINT	RW	TxPDO	0 ~ 255	1
0x3063	0xBD	Hd234	IMPE detect wait number for Sync. M, 2nd-motor	UINT	RW	TxPDO	0 ~ 255	1
0x3063	0xBE	Hd235	IMPE detect number for Sync. M, 2nd-motor	UINT	RW	TxPDO	0 ~ 255	1
0x3063	0xBF	Hd236	IMPE voltage gain for Sync. M, 2nd-motor	UINT	RW	TxPDO	0 ~ 200	1%
0x3063	0xC0	Hd237	IMPE Mg-pole position offset, 2nd-motor	UINT	RW	TxPDO	0 ~ 359	1deg

13.2.7 Code-o

Index	Sub-index	Func code	Function name	Type	Access	PDO	Setting Items	Data resolution -units
0x303F	0x9	oA-10	Operation mode on option card error (SLOT-1)	UINT	RW	PDO	0 ~ 1	1
0x303F	0xA	oA-11	Communication Watch Dog Timer (SLOT-1)	UINT	RW	PDO	0 ~ 10000	0.01s
0x303F	0xB	oA-12	Action selection at communication error (SLOT-1)	UINT	RW	TxPDO	0 ~ 4	1
0x303F	0xC	oA-13	Run command sel (OP)1	UINT	RW	TxPDO	0 ~ 1	1
0x303F	0x13	oA-20	Operation mode on option card error (SLOT-2)	UINT	RW	PDO	0 ~ 1	1
0x303F	0x14	oA-21	Communication Watch Dog Timer (SLOT-2)	UINT	RW	PDO	0 ~ 10000	0.01s
0x303F	0x15	oA-22	Action selection at communication error (SLOT-2)	UINT	RW	TxPDO	0 ~ 4	1
0x303F	0x16	oA-23	Run command sel (OP)2	UINT	RW	TxPDO	0 ~ 1	1

Index	Sub-index	Func code	Function name	Type	Access	PDO	Setting Items	Data resolution -units
0x303F	0x1D	oA-30	Operation mode on option card error (SLOT-3)	UINT	RW	PDO	0 ~ 1	1
0x303F	0x1E	oA-31	Communication Watch Dog Timer (SLOT-3)	UINT	RW	PDO	0 ~ 10000	0.01s
0x303F	0x1F	oA-32	Action selection at communication error (SLOT-3)	UINT	RW	TxPDO	0 ~ 4	1
0x303F	0x20	oA-33	Run command sel(OP)3	UINT	RW	TxPDO	0 ~ 1	1
0x303F	0x64	ob-01	Encoder constant setting	UINT	RW	TxPDO	32 ~ 65535	1pls
0x303F	0x65	ob-02	Encoder position selection	UINT	RW	TxPDO	0 ~ 1	1
0x303F	0x66	ob-03	CH1 Motor gear ratio Numerator	UINT	RW	TxPDO	1 ~ 10000	1
0x303F	0x67	ob-04	CH1 Motor gear ratio Denominator	UINT	RW	TxPDO	1 ~ 10000	1
0x303F	0x6D	ob-10	Pulse train detection object selection	UINT	RW	TxPDO	0 ~ 1	1
0x303F	0x6E	ob-11	Mode selection of pulse train input	UINT	RW	TxPDO	0 ~ 2	1
0x303F	0x6F	ob-12	Pulse train frequency Scale	UINT	RW	PDO	5 ~ 20000	0.01kHz
0x303F	0x70	ob-13	Pulse train frequency Filter time constant	UINT	RW	PDO	1 ~ 200	0.01s
0x303F	0x71	ob-14	Pulse train frequency Bias value	INT	RW	PDO	-1000 ~ 1000	0.1%
0x303F	0x72	ob-15	Pulse train frequency High Limit	UINT	RW	PDO	0 ~ 1000	0.1%
0x303F	0x73	ob-16	Pulse train frequency detection low level	UINT	RW	PDO	0 ~ 1000	0.1%
0x303F	0xC8	oC-01	Safety option input display selection	UINT	RW	TxPDO	0 ~ 1	1
0x403F	0xD1	oC-10	SS1-A deceleration time setting	UDINT	RW	TxPDO	0 ~ 360000	0.01s
0x403F	0xD3	oC-12	SLS-A deceleration time setting	UDINT	RW	TxPDO	0 ~ 360000	0.01s
0x303F	0xD5	oC-14	SLS-A Speed upper limit (Forward)	UINT	RW	PDO	0 ~ 59000	0.01Hz
0x303F	0xD6	oC-15	SLS-A Speed upper limit (Reverse)	UINT	RW	PDO	0 ~ 59000	0.01Hz
0x403F	0xD7	oC-16	SDI-A deceleration time setting	UDINT	RW	TxPDO	0 ~ 360000	0.01s
0x303F	0xD9	oC-18	SDI-A limited direction	UINT	RW	TxPDO	0 ~ 1	1

Index	Sub-index	Func code	Function name	Type	Access	PDO	Setting Items	Data resolution -units
0x403F	0xDB	oC-20	SS1-B deceleration time setting	UDINT	RW	TxPDO	0 ~ 360000	0.01s
0x403F	0xDD	oC-22	SLS-B deceleration time setting	UDINT	RW	TxPDO	0 ~ 360000	0.01s
0x303F	0xDF	oC-24	SLS-B Speed upper limit (Forward)	UINT	RW	PDO	0 ~ 59000	0.01Hz
0x303F	0xE0	oC-25	SLS-B Speed upper limit (Reverse)	UINT	RW	PDO	0 ~ 59000	0.01Hz
0x403F	0xE1	oC-26	SDI-B deceleration time setting	UDINT	RW	TxPDO	0 ~ 360000	0.01s
0x303F	0xE3	oC-28	SDI-B limited direction	UINT	RW	TxPDO	0 ~ 1	1
0x3040	0x92	oE-01	Filter time constant of Terminal [Ai4]	UINT	RW	PDO	1 ~ 500	1ms
0x3040	0x94	oE-03	Start value of Terminal [Ai4]	UINT	RW	PDO	0 ~ 10000	0.01%
0x3040	0x95	oE-04	End value of Terminal [Ai4]	UINT	RW	PDO	0 ~ 10000	0.01%
0x3040	0x96	oE-05	Start rate of Terminal [Ai4]	UINT	RW	PDO	0 ~ 1000 (oE-06)	0.1%
0x3040	0x97	oE-06	End rate of Terminal [Ai4]	UINT	RW	PDO	(oE-05) 0 ~ 1000	0.1%
0x3040	0x98	oE-07	Start point selection of Terminal [Ai6]	UINT	RW	PDO	0 ~ 1	1
0x3040	0x9C	oE-11	Filter time constant of Terminal [Ai5]	UINT	RW	PDO	1 ~ 500	1ms
0x3040	0x9E	oE-13	Start value of Terminal [Ai5]	UINT	RW	PDO	0 ~ 10000	0.01%
0x3040	0x9F	oE-14	End value of Terminal [Ai5]	UINT	RW	PDO	0 ~ 10000	0.01%
0x3040	0xA0	oE-15	Start rate of Terminal [Ai5]	UINT	RW	PDO	0 ~ 1000 (oE-16)	0.1%
0x3040	0xA1	oE-16	End rate of Terminal [Ai5]	UINT	RW	PDO	(oE-15) 0 ~ 1000	0.1%
0x3040	0xA2	oE-17	Start point selection of Terminal [Ai5]	UINT	RW	PDO	0 ~ 1	1
0x3040	0xA6	oE-21	Filter time constant of Terminal [Ai6]	UINT	RW	PDO	1 ~ 500	1ms
0x3040	0xA8	oE-23	Start value of Terminal [Ai6]	INT	RW	PDO	-10000 ~ 10000	0.01%
0x3040	0xA9	oE-24	End value of Terminal [Ai6]	INT	RW	PDO	-10000 ~ 10000	0.01%
0x3040	0xAA	oE-25	Start rate of Terminal [Ai6]	INT	RW	PDO	-1000 ~ 1000 (oE-26)	0.1%
0x3040	0xAB	oE-26	End rate of Terminal [Ai6]	INT	RW	PDO	(oE-25) -1000 ~ 1000	0.1%
0x3040	0xAD	oE-28	Ai4 Voltage/Current zero-gain adjustment	INT	RW	PDO	-10000 ~ 10000	0.01%

Index	Sub-index	Func code	Function name	Type	Access	PDO	Setting Items	Data resolution -units
0x3040	0xAE	oE-29	Ai4 Voltage/Current gain adjustment	UINT	RW	PDO	0 ~ 20000	0.01%
0x3040	0xAF	oE-30	Ai5 Voltage/Current zero-gain adjustment	INT	RW	PDO	-10000 ~ 10000	0.01%
0x3040	0xB0	oE-31	Ai5 Voltage/Current gain adjustment	UINT	RW	PDO	0 ~ 20000	0.01%
0x3040	0xB1	oE-32	Ai6 Voltage zero-gain adjustment	INT	RW	PDO	-10000 ~ 10000	0.01%
0x3040	0xB2	oE-33	Ai6 Voltage gain adjustment	UINT	RW	PDO	0 ~ 20000	0.01%
0x3040	0xB4	oE-35	Window compareter for [Ai4] higher level	UINT	RW	PDO	0 ~ 100	1%
0x3040	0xB5	oE-36	Window compareter for [Ai4] lower level	UINT	RW	PDO	0 ~ 100	1%
0x3040	0xB6	oE-37	Window compareter for [Ai4] hysteresis width	UINT	RW	PDO	0 ~ 10	1%
0x3040	0xB7	oE-38	Window compareter for [Ai5] higher level	UINT	RW	PDO	0 ~ 100	1%
0x3040	0xB8	oE-39	Window compareter for [Ai5] lower level	UINT	RW	PDO	0 ~ 100	1%
0x3040	0xB9	oE-40	Window compareter for [Ai5] hysteresis width	UINT	RW	PDO	0 ~ 10	1%
0x3040	0xBA	oE-41	Window compareter for [Ai6] higher level	INT	RW	PDO	-100 ~ 100	1%
0x3040	0xBB	oE-42	Window compareter for [Ai6] lower level	INT	RW	PDO	-100 ~ 100	1%
0x3040	0xBC	oE-43	Window compareter for [Ai6] hysteresis width	UINT	RW	PDO	0 ~ 10	1%
0x3040	0xBD	oE-44	Operation level at [AI4] disconnection	UINT	RW	PDO	0 ~ 100	1%
0x3040	0xBE	oE-45	Operation level selection at [Ai4] disconnection	UINT	RW	PDO	0 ~ 2	1
0x3040	0xBF	oE-46	Operation level at [Ai5] disconnection	UINT	RW	PDO	0 ~ 100	1%

Index	Sub-index	Func code	Function name	Type	Access	PDO	Setting Items	Data resolution -units
0x3040	0xC0	oE-47	Operation level selection at [Ai5] disconnection	UINT	RW	PDO	0 ~ 2	1
0x3040	0xC1	oE-48	Operation level at [Ai6] disconnection	INT	RW	PDO	-100 ~ 100	1%
0x3040	0xC2	oE-49	Operation level selection at [Ai6] disconnection	UINT	RW	PDO	0 ~ 2	1
0x3040	0xC3	oE-50	Ao3 monitor output selection	UINT	RW	PDO	0 ~ 65535 (register number)	1
0x3040	0xC4	oE-51	Ao4 monitor output selection	UINT	RW	PDO	0 ~ 65535 (register number)	1
0x3040	0xC5	oE-52	Ao5 monitor output selection	UINT	RW	PDO	0 ~ 65535 (register number)	1
0x3040	0xC9	oE-56	Filter time constant of [Ao3] monitor	UINT	RW	PDO	1 ~ 500	1ms
0x3040	0xCA	oE-57	Ao3 Data type selection	UINT	RW	PDO	0 ~ 1	1
0x3040	0xCB	oE-58	Ao3 monitor bias adjustment	INT	RW	PDO	-1000 ~ 1000	0.1%
0x3040	0xCC	oE-59	Ao3 monitor gain adjustment	INT	RW	PDO	-10000 ~ 10000	0.1%
0x3040	0xCD	oE-60	Output level setting at [Ao3] monitor adjust mode	INT	RW	PDO	-1000 ~ 1000	0.1%
0x3040	0xCE	oE-61	Filter time constant of [Ao4] monitor	UINT	RW	PDO	1 ~ 500	1ms
0x3040	0xCF	oE-62	Ao4 Data type selection	UINT	RW	PDO	0 ~ 1	1
0x3040	0xD0	oE-63	Ao4 monitor bias adjustment	INT	RW	PDO	-1000 ~ 1000	0.1%
0x3040	0xD1	oE-64	Ao4 monitor gain adjustment	INT	RW	PDO	-10000 ~ 10000	0.1%
0x3040	0xD2	oE-65	Output level setting at [Ao4] monitor adjust mode	INT	RW	PDO	-1000 ~ 1000	0.1%
0x3040	0xD3	oE-66	Filter time constant of [Ao5] monitor	UINT	RW	PDO	1 ~ 500	1ms
0x3040	0xD4	oE-67	Ao5 Data type selection	UINT	RW	PDO	0 ~ 1	1
0x3040	0xD5	oE-68	Ao5 monitor bias adjustment	INT	RW	PDO	-1000 ~ 1000	0.1%
0x3040	0xD6	oE-69	Ao5 monitor gain adjustment	INT	RW	PDO	-10000 ~ 10000	0.1%
0x3040	0xD7	oE-70	Output level setting at [Ao5] monitor adjust mode	INT	RW	PDO	-1000 ~ 1000	0.1%
0x3041	0xC0	oH-01	IP-Address selection (P1-EN)	UINT	RW	TxPDO	0 ~ 1	1

Index	Sub-index	Func code	Function name	Type	Access	PDO	Setting Items	Data resolution -units
0x3041	0xC1	oH-02	Communication speed (port-1) (P1-EN)	UINT	RW	TxPDO	0 ~ 4	1
0x3041	0xC2	oH-03	Communication speed (port-2) (P1-EN)	UINT	RW	TxPDO	0 ~ 4	1
0x3041	0xC3	oH-04	Ethernet communication timeout (P1-EN)	UINT	RW	TxPDO	1 ~ 65535	1(*10ms)
0x3041	0xC4	oH-05	Modbus TCP Port No. (IPv4)	UINT	RW	TxPDO	502, 1024 ~ 65535	1
0x3041	0xC5	oH-06	Modbus TCP Port No. (IPv6)	UINT	RW	TxPDO	502, 1024 ~ 65535	1
0x3041	0xD3	oH-20	Profibus Node address	UINT	RW	TxPDO	0 ~ 125	1
0x3041	0xD4	oH-21	Profibus clear mode selection	UINT	RW	TxPDO	0 ~ 1	1
0x3041	0xD5	oH-22	Profibus Map selection	UINT	RW	TxPDO	0 ~ 2	1
0x3041	0xD6	oH-23	Setting enable from Profi master	UINT	RW	TxPDO	0 ~ 1	1
0x3041	0xD7	oH-24	Setpoint telegram/Actual value telegram Gr. Selection (P1-PB)	UINT	RW	TxPDO	0 ~ 2	1
0x3041	0xDD	oH-30	IP-Address selection (P1-PN)	UINT	RW	TxPDO	0 ~ 1	1
0x3041	0xDE	oH-31	Communication speed (port-1) (P1-PN)	UINT	RW	TxPDO	0 ~ 4	1
0x3041	0xDF	oH-32	Communication speed (port-2) (P1-PN)	UINT	RW	TxPDO	0 ~ 4	1
0x3041	0xE0	oH-33	Ethernet communication timeout (P1-PN)	UINT	RW	TxPDO	1 ~ 65535	1(*10ms)
0x3041	0xE1	oH-34	Setpoint telegram/Actual value telegram Gr. Selection (P1-PN)	UINT	RW	TxPDO	0 ~ 2	1
0x3042	0x26	oJ-01	Flexible command registration writing register 1, Gr. A	UINT	RW	TxPDO	0 ~ 65535	1
0x3042	0x27	oJ-02	Flexible command registration writing register 2, Gr. A	UINT	RW	TxPDO	0 ~ 65535	1
0x3042	0x28	oJ-03	Flexible command registration writing register 3, Gr. A	UINT	RW	TxPDO	0 ~ 65535	1
0x3042	0x29	oJ-04	Flexible command registration writing register 4, Gr. A	UINT	RW	TxPDO	0 ~ 65535	1

Index	Sub-index	Func code	Function name	Type	Access	PDO	Setting Items	Data resolution -units
0x3042	0x2A	oJ-05	Flexible command registration writing register 5, Gr. A	UINT	RW	TxPDO	0 ~ 65535	1
0x3042	0x2B	oJ-06	Flexible command registration writing register 6, Gr. A	UINT	RW	TxPDO	0 ~ 65535	1
0x3042	0x2C	oJ-07	Flexible command registration writing register 7, Gr. A	UINT	RW	TxPDO	0 ~ 65535	1
0x3042	0x2D	oJ-08	Flexible command registration writing register 8, Gr. A	UINT	RW	TxPDO	0 ~ 65535	1
0x3042	0x2E	oJ-09	Flexible command registration writing register 9, Gr. A	UINT	RW	TxPDO	0 ~ 65535	1
0x3042	0x2F	oJ-10	Flexible command registration writing register 10, Gr. A	UINT	RW	TxPDO	0 ~ 65535	1
0x3042	0x30	oJ-11	Flexible command registration Reading register 1, Gr. A	UINT	RW	TxPDO	0 ~ 65535	1
0x3042	0x31	oJ-12	Flexible command registration Reading register 2, Gr. A	UINT	RW	TxPDO	0 ~ 65535	1
0x3042	0x32	oJ-13	Flexible command registration Reading register 3, Gr. A	UINT	RW	TxPDO	0 ~ 65535	1
0x3042	0x33	oJ-14	Flexible command registration Reading register 4, Gr. A	UINT	RW	TxPDO	0 ~ 65535	1
0x3042	0x34	oJ-15	Flexible command registration Reading register 5, Gr. A	UINT	RW	TxPDO	0 ~ 65535	1
0x3042	0x35	oJ-16	Flexible command registration Reading register 6, Gr. A	UINT	RW	TxPDO	0 ~ 65535	1
0x3042	0x36	oJ-17	Flexible command registration Reading register 7, Gr. A	UINT	RW	TxPDO	0 ~ 65535	1
0x3042	0x37	oJ-18	Flexible command registration Reading register 8, Gr. A	UINT	RW	TxPDO	0 ~ 65535	1
0x3042	0x38	oJ-19	Flexible command registration Reading register 9, Gr. A	UINT	RW	TxPDO	0 ~ 65535	1

Index	Sub-index	Func code	Function name	Type	Access	PDO	Setting Items	Data resolution -units
0x3042	0x39	oJ-20	Flexible command registration Reading register 10, Gr. A	UINT	RW	TxPDO	0 ~ 65535	1
0x3042	0x3A	oJ-21	Flexible command registration writing register 1, Gr. B	UINT	RW	TxPDO	0 ~ 65535	1
0x3042	0x3B	oJ-22	Flexible command registration writing register 2, Gr. B	UINT	RW	TxPDO	0 ~ 65535	1
0x3042	0x3C	oJ-23	Flexible command registration writing register 3, Gr. B	UINT	RW	TxPDO	0 ~ 65535	1
0x3042	0x3D	oJ-24	Flexible command registration writing register 4, Gr. B	UINT	RW	TxPDO	0 ~ 65535	1
0x3042	0x3E	oJ-25	Flexible command registration writing register 5, Gr. B	UINT	RW	TxPDO	0 ~ 65535	1
0x3042	0x3F	oJ-26	Flexible command registration writing register 6, Gr. B	UINT	RW	TxPDO	0 ~ 65535	1
0x3042	0x40	oJ-27	Flexible command registration writing register 7, Gr. B	UINT	RW	TxPDO	0 ~ 65535	1
0x3042	0x41	oJ-28	Flexible command registration writing register 8, Gr. B	UINT	RW	TxPDO	0 ~ 65535	1
0x3042	0x42	oJ-29	Flexible command registration writing register 9, Gr. B	UINT	RW	TxPDO	0 ~ 65535	1
0x3042	0x43	oJ-30	Flexible command registration writing register 10, Gr. B	UINT	RW	TxPDO	0 ~ 65535	1
0x3042	0x44	oJ-31	Flexible command registration Reading register 1, Gr. B	UINT	RW	TxPDO	0 ~ 65535	1
0x3042	0x45	oJ-32	Flexible command registration Reading register 2, Gr. B	UINT	RW	TxPDO	0 ~ 65535	1
0x3042	0x46	oJ-33	Flexible command registration Reading register 3, Gr. B	UINT	RW	TxPDO	0 ~ 65535	1
0x3042	0x47	oJ-34	Flexible command registration Reading register 4, Gr. B	UINT	RW	TxPDO	0 ~ 65535	1

Index	Sub-index	Func code	Function name	Type	Access	PDO	Setting Items	Data resolution -units
0x3042	0x48	oJ-35	Flexible command registration Reading register 5, Gr. B	UINT	RW	TxPDO	0 ~ 65535	1
0x3042	0x49	oJ-36	Flexible command registration Reading register 6, Gr. B	UINT	RW	TxPDO	0 ~ 65535	1
0x3042	0x4A	oJ-37	Flexible command registration Reading register 7, Gr. B	UINT	RW	TxPDO	0 ~ 65535	1
0x3042	0x4B	oJ-38	Flexible command registration Reading register 8, Gr. B	UINT	RW	TxPDO	0 ~ 65535	1
0x3042	0x4C	oJ-39	Flexible command registration Reading register 9, Gr. B	UINT	RW	TxPDO	0 ~ 65535	1
0x3042	0x4D	oJ-40	Flexible command registration Reading register 10, Gr. B	UINT	RW	TxPDO	0 ~ 65535	1
0x3042	0x4E	oJ-41	Flexible command registration writing register 1, Gr. C	UINT	RW	TxPDO	0 ~ 65535	1
0x3042	0x4F	oJ-42	Flexible command registration writing register 2, Gr. C	UINT	RW	TxPDO	0 ~ 65535	1
0x3042	0x50	oJ-43	Flexible command registration writing register 3, Gr. C	UINT	RW	TxPDO	0 ~ 65535	1
0x3042	0x51	oJ-44	Flexible command registration writing register 4, Gr. C	UINT	RW	TxPDO	0 ~ 65535	1
0x3042	0x52	oJ-45	Flexible command registration writing register 5, Gr. C	UINT	RW	TxPDO	0 ~ 65535	1
0x3042	0x53	oJ-46	Flexible command registration writing register 6, Gr. C	UINT	RW	TxPDO	0 ~ 65535	1
0x3042	0x54	oJ-47	Flexible command registration writing register 7, Gr. C	UINT	RW	TxPDO	0 ~ 65535	1
0x3042	0x55	oJ-48	Flexible command registration writing register 8, Gr. C	UINT	RW	TxPDO	0 ~ 65535	1
0x3042	0x56	oJ-49	Flexible command registration writing register 9, Gr. C	UINT	RW	TxPDO	0 ~ 65535	1

Index	Sub-index	Func code	Function name	Type	Access	PDO	Setting Items	Data resolution -units
0x3042	0x57	oJ-50	Flexible command registration writing register 10, Gr.C	UINT	RW	TxPDO	0 ~ 65535	1
0x3042	0x58	oJ-51	Flexible command registration Reading register 1, Gr.C	UINT	RW	TxPDO	0 ~ 65535	1
0x3042	0x59	oJ-52	Flexible command registration Reading register 2, Gr.C	UINT	RW	TxPDO	0 ~ 65535	1
0x3042	0x5A	oJ-53	Flexible command registration Reading register 3, Gr.C	UINT	RW	TxPDO	0 ~ 65535	1
0x3042	0x5B	oJ-54	Flexible command registration Reading register 4, Gr.C	UINT	RW	TxPDO	0 ~ 65535	1
0x3042	0x5C	oJ-55	Flexible command registration Reading register 5, Gr.C	UINT	RW	TxPDO	0 ~ 65535	1
0x3042	0x5D	oJ-56	Flexible command registration Reading register 6, Gr.C	UINT	RW	TxPDO	0 ~ 65535	1
0x3042	0x5E	oJ-57	Flexible command registration Reading register 7, Gr.C	UINT	RW	TxPDO	0 ~ 65535	1
0x3042	0x5F	oJ-58	Flexible command registration Reading register 8, Gr.C	UINT	RW	TxPDO	0 ~ 65535	1
0x3042	0x60	oJ-59	Flexible command registration Reading register 9, Gr.C	UINT	RW	TxPDO	0 ~ 65535	1
0x3042	0x61	oJ-60	Flexible command registration Reading register 10, Gr.C	UINT	RW	TxPDO	0 ~ 65535	1
0x3042	0x8A	oL-01	IPv4 IP address (1), Gr.1	UINT	RW	TxPDO	0 ~ 255	1
0x3042	0x8B	oL-02	IPv4 IP address (2), Gr.1	UINT	RW	TxPDO	0 ~ 255	1
0x3042	0x8C	oL-03	IPv4 IP address (3), Gr.1	UINT	RW	TxPDO	0 ~ 255	1
0x3042	0x8D	oL-04	IPv4 IP address (4), Gr.1	UINT	RW	TxPDO	0 ~ 255	1
0x3042	0x8E	oL-05	IPv4 Sub-net mask (1), Gr.1	UINT	RW	TxPDO	0 ~ 255	1
0x3042	0x8F	oL-06	IPv4 Sub-net mask (2), Gr.1	UINT	RW	TxPDO	0 ~ 255	1
0x3042	0x90	oL-07	IPv4 Sub-net mask (3), Gr.1	UINT	RW	TxPDO	0 ~ 255	1

Index	Sub-index	Func code	Function name	Type	Access	PDO	Setting Items	Data resolution -units
0x3042	0x91	oL-08	IPv4 Sub-net mask (4), Gr. 1	UINT	RW	TxPDO	0 ~ 255	1
0x3042	0x92	oL-09	IPv4 Default gateway (1), Gr. 1	UINT	RW	TxPDO	0 ~ 255	1
0x3042	0x93	oL-10	IPv4 Default gateway (2), Gr. 1	UINT	RW	TxPDO	0 ~ 255	1
0x3042	0x94	oL-11	IPv4 Default gateway (3), Gr. 1	UINT	RW	TxPDO	0 ~ 255	1
0x3042	0x95	oL-12	IPv4 Default gateway (4), Gr. 1	UINT	RW	TxPDO	0 ~ 255	1
0x3042	0x9D	oL-20	IPv6 IP address (1), Gr. 1	UINT	RW	TxPDO	0 ~ 65535	1
0x3042	0x9E	oL-21	IPv6 IP address (2), Gr. 1	UINT	RW	TxPDO	0 ~ 65535	1
0x3042	0x9F	oL-22	IPv6 IP address (3), Gr. 1	UINT	RW	TxPDO	0 ~ 65535	1
0x3042	0xA0	oL-23	IPv6 IP address (4), Gr. 1	UINT	RW	TxPDO	0 ~ 65535	1
0x3042	0xA1	oL-24	IPv6 IP address (5), Gr. 1	UINT	RW	TxPDO	0 ~ 65535	1
0x3042	0xA2	oL-25	IPv6 IP address (6), Gr. 1	UINT	RW	TxPDO	0 ~ 65535	1
0x3042	0xA3	oL-26	IPv6 IP address (7), Gr. 1	UINT	RW	TxPDO	0 ~ 65535	1
0x3042	0xA4	oL-27	IPv6 IP address (8), Gr. 1	UINT	RW	TxPDO	0 ~ 65535	1
0x3042	0xA5	oL-28	IPv6 Prefix of Sub-net, Gr. 1	UINT	RW	TxPDO	0 ~ 127	1
0x3042	0xA6	oL-29	IPv6 Default gateway (1), Gr. 1	UINT	RW	TxPDO	0 ~ 65535	1
0x3042	0xA7	oL-30	IPv6 Default gateway (2), Gr. 1	UINT	RW	TxPDO	0 ~ 65535	1
0x3042	0xA8	oL-31	IPv6 Default gateway (3), Gr. 1	UINT	RW	TxPDO	0 ~ 65535	1
0x3042	0xA9	oL-32	IPv6 Default gateway (4), Gr. 1	UINT	RW	TxPDO	0 ~ 65535	1
0x3042	0xAA	oL-33	IPv6 Default gateway (5), Gr. 1	UINT	RW	TxPDO	0 ~ 65535	1
0x3042	0xAB	oL-34	IPv6 Default gateway (6), Gr. 1	UINT	RW	TxPDO	0 ~ 65535	1
0x3042	0xAC	oL-35	IPv6 Default gateway (7), Gr. 1	UINT	RW	TxPDO	0 ~ 65535	1
0x3042	0xAD	oL-36	IPv6 Default gateway (8), Gr. 1	UINT	RW	TxPDO	0 ~ 65535	1
0x3042	0xB1	oL-40	IPv4 IP address (1), Gr. 2	UINT	RW	TxPDO	0 ~ 255	1
0x3042	0xB2	oL-41	IPv4 IP address (2), Gr. 2	UINT	RW	TxPDO	0 ~ 255	1
0x3042	0xB3	oL-42	IPv4 IP address (3), Gr. 2	UINT	RW	TxPDO	0 ~ 255	1
0x3042	0xB4	oL-43	IPv4 IP address (4), Gr. 2	UINT	RW	TxPDO	0 ~ 255	1
0x3042	0xB5	oL-44	IPv4 Sub-net mask (1), Gr. 2	UINT	RW	TxPDO	0 ~ 255	1
0x3042	0xB6	oL-45	IPv4 Sub-net mask (2), Gr. 2	UINT	RW	TxPDO	0 ~ 255	1
0x3042	0xB7	oL-46	IPv4 Sub-net mask (3), Gr. 2	UINT	RW	TxPDO	0 ~ 255	1

Index	Sub-index	Func code	Function name	Type	Access	PDO	Setting Items	Data resolution -units
0x3042	0xB8	oL-47	IPv4 Sub-net mask (4), Gr. 2	UINT	RW	TxPDO	0 ~ 255	1
0x3042	0xB9	oL-48	IPv4 Default gateway (1), Gr. 2	UINT	RW	TxPDO	0 ~ 255	1
0x3042	0xBA	oL-49	IPv4 Default gateway (2), Gr. 2	UINT	RW	TxPDO	0 ~ 255	1
0x3042	0xBB	oL-50	IPv4 Default gateway (3), Gr. 2	UINT	RW	TxPDO	0 ~ 255	1
0x3042	0xBC	oL-51	IPv4 Default gateway (4), Gr. 2	UINT	RW	TxPDO	0 ~ 255	1
0x3042	0xC5	oL-60	IPv6 IP address (1), Gr. 2	UINT	RW	TxPDO	0 ~ 65535	1
0x3042	0xC6	oL-61	IPv6 IP address (2), Gr. 2	UINT	RW	TxPDO	0 ~ 65535	1
0x3042	0xC7	oL-62	IPv6 IP address (3), Gr. 2	UINT	RW	TxPDO	0 ~ 65535	1
0x3042	0xC8	oL-63	IPv6 IP address (4), Gr. 2	UINT	RW	TxPDO	0 ~ 65535	1
0x3042	0xC9	oL-64	IPv6 IP address (5), Gr. 2	UINT	RW	TxPDO	0 ~ 65535	1
0x3042	0xCA	oL-65	IPv6 IP address (6), Gr. 2	UINT	RW	TxPDO	0 ~ 65535	1
0x3042	0xCB	oL-66	IPv6 IP address (7), Gr. 2	UINT	RW	TxPDO	0 ~ 65535	1
0x3042	0xCC	oL-67	IPv6 IP address (8), Gr. 2	UINT	RW	TxPDO	0 ~ 65535	1
0x3042	0xCD	oL-68	IPv6 Prefix of Sub-net, Gr. 2	UINT	RW	TxPDO	0 ~ 127	1
0x3042	0xCE	oL-69	IPv6 Default gateway (1), Gr. 2	UINT	RW	TxPDO	0 ~ 65535	1
0x3042	0xCF	oL-70	IPv6 Default gateway (2), Gr. 2	UINT	RW	TxPDO	0 ~ 65535	1
0x3042	0xD0	oL-71	IPv6 Default gateway (3), Gr. 2	UINT	RW	TxPDO	0 ~ 65535	1
0x3042	0xD1	oL-72	IPv6 Default gateway (4), Gr. 2	UINT	RW	TxPDO	0 ~ 65535	1
0x3042	0xD2	oL-73	IPv6 Default gateway (5), Gr. 2	UINT	RW	TxPDO	0 ~ 65535	1
0x3042	0xD3	oL-74	IPv6 Default gateway (6), Gr. 2	UINT	RW	TxPDO	0 ~ 65535	1
0x3042	0xD4	oL-75	IPv6 Default gateway (7), Gr. 2	UINT	RW	TxPDO	0 ~ 65535	1
0x3042	0xD5	oL-76	IPv6 Default gateway (8), Gr. 2	UINT	RW	TxPDO	0 ~ 65535	1

13.2.8 Code-P

Index	Sub-index	Func code	Function name	Type	Access	PDO	Setting Items	Data resolution -units
0x3042	0xEE	PA-01	Mode selection for Emergency-force drive	UINT	RW	TxPDO	0 ~ 1	1

Index	Sub-index	Func code	Function name	Type	Access	PDO	Setting Items	Data resolution -units
0x3042	0xEF	PA-02	Frequency reference setting at Emergency-force drive	UINT	RW	TxPDO	0 ~ 59000	0.01Hz
0x3042	0xF0	PA-03	Direction command at Emergency-force drive	UINT	RW	TxPDO	0 ~ 1	1
0x3042	0xF1	PA-04	Commercial power supply bypass function selection	UINT	RW	TxPDO	0 ~ 1	1
0x3042	0xF2	PA-05	Delay time of Bypass function	UINT	RW	TxPDO	0 ~ 10000	0.1s
0x3043	0x3	PA-20	Simulation mode enable	UINT	RW	TxPDO	0 ~ 1	1
0x3043	0x4	PA-21	Error code selection for Alarm test	UINT	RW	PDO	0 ~ 255	1
0x3043	0x5	PA-22	Output current monitor optional output enable	UINT	RW	PDO	0 ~ 7	1
0x3043	0x6	PA-23	Output current monitor optional output value setting	UINT	RW	PDO	(0~3.00)*CTL Rated current	0.1A
0x3043	0x7	PA-24	DC-bus voltage monitor optional output enable	UINT	RW	PDO	0 ~ 7	1
0x3043	0x8	PA-25	DC-bus voltage monitor optional value output	UINT	RW	PDO	200V class: 0 ~ 4500 400V class: 0 ~ 9000	0.1Vdc
0x3043	0x9	PA-26	Output voltage monitor optional output enable	UINT	RW	PDO	0 ~ 7	1
0x3043	0xA	PA-27	Output voltage monitor optional output value setting	UINT	RW	PDO	200V class: 0 ~ 3000 400V class: 0 ~ 6000	0.1V
0x3043	0xB	PA-28	Output torque monitor optional output enable	UINT	RW	PDO	0 ~ 7	1
0x3043	0xC	PA-29	Output torque monitor optional output value setting	INT	RW	PDO	-5000 ~ 5000	0.1%
0x3043	0xD	PA-30	Start with frequency matching optional Setting enable	UINT	RW	PDO	0 ~ 7	1
0x3043	0xE	PA-31	Start with frequency matching optional value setting	UINT	RW	PDO	0 ~ 59000	0.01Hz

13.2.9 Code-U

Index	Sub-index	Func code	Function name	Type	Access	PDO	Setting Items	Data resolution ·units
0x3046	0xDE	UA-01	Password for Display	UINT	RW	TxPDO	0 ~ 65535	1
0x3046	0xDF	UA-02	Password for SoftLock	UINT	RW	TxPDO	0 ~ 65535	1
0x3046	0xE7	UA-10	Display restriction selection	UINT	RW	TxPDO	0 ~ 4	1
0x3046	0xE9	UA-12	Accumulation input power monitor clear	UINT	RW	PDO	0 ~ 1	1
0x3046	0xEA	UA-13	Display gain for Accumulation input power monitor	UINT	RW	PDO	1 ~ 1000	1
0x3046	0xEB	UA-14	Accumulation output power monitor clear	UINT	RW	PDO	0 ~ 1	1
0x3046	0xEC	UA-15	Display gain for Accumulation output power monitor	UINT	RW	PDO	1 ~ 1000	1
0x3046	0xED	UA-16	Soft Lock selection	UINT	RW	PDO	0 ~ 1	1
0x3046	0xEE	UA-17	Soft Lock target selection	UINT	RW	PDO	0 ~ 1	1
0x3046	0xEF	UA-18	Data R/W selection	UINT	RW	TxPDO	0 ~ 1	1
0x3046	0xF0	UA-19	Low battery warning enable	UINT	RW	TxPDO	0 ~ 2	1
0x3046	0xF1	UA-20	Action selection at keypad disconnection	UINT	RW	TxPDO	0 ~ 4	1
0x3046	0xF2	UA-21	2nd-motor parameter display selection	UINT	RW	TxPDO	0 ~ 1	1
0x3046	0xF3	UA-22	Option parameter display selection at Full display	UINT	RW	TxPDO	0 ~ 1	1
0x3046	0xFB	UA-30	User parameter auto setting function enable	UINT	RW	TxPDO	0 ~ 1	1
0x3046	0xFC	UA-31	User parameter 1 selection	UINT	RW	PDO	0 ~ 65535 (register number)	1
0x3046	0xFD	UA-32	User parameter 2 selection	UINT	RW	PDO	0 ~ 65535 (register number)	1
0x3046	0xFE	UA-33	User parameter 3 selection	UINT	RW	PDO	0 ~ 65535 (register number)	1
0x3047	0x1	UA-34	User parameter 4 selection	UINT	RW	PDO	0 ~ 65535 (register number)	1
0x3047	0x2	UA-35	User parameter 5 selection	UINT	RW	PDO	0 ~ 65535 (register number)	1
0x3047	0x3	UA-36	User parameter 6 selection	UINT	RW	PDO	0 ~ 65535 (register number)	1

Index	Sub-index	Func code	Function name	Type	Access	PDO	Setting Items	Data resolution -units
0x3047	0x4	UA-37	User parameter 7 selection	UINT	RW	PDO	0 ~ 65535 (register number)	1
0x3047	0x5	UA-38	User parameter 8 selection	UINT	RW	PDO	0 ~ 65535 (register number)	1
0x3047	0x6	UA-39	User parameter 9 selection	UINT	RW	PDO	0 ~ 65535 (register number)	1
0x3047	0x7	UA-40	User parameter 10 selection	UINT	RW	PDO	0 ~ 65535 (register number)	1
0x3047	0x8	UA-41	User parameter 11 selection	UINT	RW	PDO	0 ~ 65535 (register number)	1
0x3047	0x9	UA-42	User parameter 12 selection	UINT	RW	PDO	0 ~ 65535 (register number)	1
0x3047	0xA	UA-43	User parameter 13 selection	UINT	RW	PDO	0 ~ 65535 (register number)	1
0x3047	0xB	UA-44	User parameter 14 selection	UINT	RW	PDO	0 ~ 65535 (register number)	1
0x3047	0xC	UA-45	User parameter 15 selection	UINT	RW	PDO	0 ~ 65535 (register number)	1
0x3047	0xD	UA-46	User parameter 16 selection	UINT	RW	PDO	0 ~ 65535 (register number)	1
0x3047	0xE	UA-47	User parameter 17 selection	UINT	RW	PDO	0 ~ 65535 (register number)	1
0x3047	0xF	UA-48	User parameter 18 selection	UINT	RW	PDO	0 ~ 65535 (register number)	1
0x3047	0x10	UA-49	User parameter 19 selection	UINT	RW	PDO	0 ~ 65535 (register number)	1
0x3047	0x11	UA-50	User parameter 20 selection	UINT	RW	PDO	0 ~ 65535 (register number)	1
0x3047	0x12	UA-51	User parameter 21 selection	UINT	RW	PDO	0 ~ 65535 (register number)	1
0x3047	0x13	UA-52	User parameter 22 selection	UINT	RW	PDO	0 ~ 65535 (register number)	1
0x3047	0x14	UA-53	User parameter 23 selection	UINT	RW	PDO	0 ~ 65535 (register number)	1
0x3047	0x15	UA-54	User parameter 24 selection	UINT	RW	PDO	0 ~ 65535 (register number)	1
0x3047	0x16	UA-55	User parameter 25 selection	UINT	RW	PDO	0 ~ 65535 (register number)	1
0x3047	0x17	UA-56	User parameter 26 selection	UINT	RW	PDO	0 ~ 65535 (register number)	1
0x3047	0x18	UA-57	User parameter 27 selection	UINT	RW	PDO	0 ~ 65535 (register number)	1
0x3047	0x19	UA-58	User parameter 28 selection	UINT	RW	PDO	0 ~ 65535 (register number)	1
0x3047	0x1A	UA-59	User parameter 29 selection	UINT	RW	PDO	0 ~ 65535 (register number)	1
0x3047	0x1B	UA-60	User parameter 30 selection	UINT	RW	PDO	0 ~ 65535 (register number)	1
0x3047	0x1C	UA-61	User parameter 31 selection	UINT	RW	PDO	0 ~ 65535 (register number)	1
0x3047	0x1D	UA-62	User parameter 32 selection	UINT	RW	PDO	0 ~ 65535 (register number)	1
0x3047	0x39	UA-90	Keypad indication off waiting time	UINT	RW	TxPDO	0 ~ 60	1min
0x3047	0x3A	UA-91	Initial Disply selection	UINT	RW	TxPDO	0 ~ 65535 (d,Fcode register number)	1

Index	Sub-index	Func code	Function name	Type	Access	PDO	Setting Items	Data resolution -units
0x3047	0x3B	UA-92	Auto-return to Initial display enable	UINT	RW	TxPDO	0 ~ 1	1
0x3047	0x3C	UA-93	Setting enable at Monitor display	UINT	RW	TxPDO	0 ~ 1	1
0x3047	0x3D	UA-94	Multispeed change on the frequency reference monitor display	UINT	RW	TxPDO	0 ~ 1	1
0x3047	0x44	Ub-01	Initialize Mode selection	UINT	RW	TxPDO	0 ~ 8	1
0x3047	0x45	Ub-02	Initialize Data sel	UINT	RW	TxPDO	0 ~ 3	1
0x3047	0x46	Ub-03	Load type selection	UINT	RW	TxPDO	0 ~ 2	1
0x3047	0x48	Ub-05	Initialize Enable	UINT	RW	TxPDO	0 ~ 1	1
0x3047	0xA8	UC-01	Debug mode enable	UINT	RW	PDO	0 ~ 3	1
0x3048	0xE	Ud-01	Trace function enable	UINT	RW	PDO	0 ~ 1	1
0x3048	0xF	Ud-02	Trace start	UINT	RW	PDO	0 ~ 1	1
0x3048	0x10	Ud-03	Trace data number setting	UINT	RW	PDO	0 ~ 8	1
0x3048	0x11	Ud-04	Trace signal number setting	UINT	RW	PDO	0 ~ 8	1
0x3048	0x17	Ud-10	Trace data 0 selection	UINT	RW	PDO	0 ~ 65535 (d,Fcode register number)	1
0x3048	0x18	Ud-11	Trace data 1 selection	UINT	RW	PDO	0 ~ 65535 (d,Fcode register number)	1
0x3048	0x19	Ud-12	Trace data 2 selection	UINT	RW	PDO	0 ~ 65535 (d,Fcode register number)	1
0x3048	0x1A	Ud-13	Trace data 3 selection	UINT	RW	PDO	0 ~ 65535 (d,Fcode register number)	1
0x3048	0x1B	Ud-14	Trace data 4 selection	UINT	RW	PDO	0 ~ 65535 (d,Fcode register number)	1
0x3048	0x1C	Ud-15	Trace data 5 selection	UINT	RW	PDO	0 ~ 65535 (d,Fcode register number)	1
0x3048	0x1D	Ud-16	Trace data 6 selection	UINT	RW	PDO	0 ~ 65535 (d,Fcode register number)	1
0x3048	0x1E	Ud-17	Trace data 7 selection	UINT	RW	PDO	0 ~ 65535 (d,Fcode register number)	1
0x3048	0x21	Ud-20	Trace signal 0 Input/Output selection	UINT	RW	PDO	0 ~ 1	1
0x3048	0x22	Ud-21	Trace signal 0 Input Terminal selection	UINT	RW	PDO	0 ~ 110	1
0x3048	0x23	Ud-22	Trace signal 0 Output Terminal selection	UINT	RW	PDO	0 ~ 93	1
0x3048	0x24	Ud-23	Trace signal 1 Input/Output selection	UINT	RW	PDO	0 ~ 1	1
0x3048	0x25	Ud-24	Trace signal 1 Input Terminal selection	UINT	RW	PDO	0 ~ 110	1

Index	Sub-index	Func code	Function name	Type	Access	PDO	Setting Items	Data resolution -units
0x3048	0x26	Ud-25	Trace signal 1 Output Terminal selection	UINT	RW	PDO	0 ~ 93	1
0x3048	0x27	Ud-26	Trace signal 2 Input/Output selection	UINT	RW	PDO	0 ~ 1	1
0x3048	0x28	Ud-27	Trace signal 2 Input Terminal selection	UINT	RW	PDO	0 ~ 110	1
0x3048	0x29	Ud-28	Trace signal 2 Output Terminal selection	UINT	RW	PDO	0 ~ 93	1
0x3048	0x2A	Ud-29	Trace signal 3 Input/Output selection	UINT	RW	PDO	0 ~ 1	1
0x3048	0x2B	Ud-30	Trace signal 3 Input Terminal selection	UINT	RW	PDO	0 ~ 110	1
0x3048	0x2C	Ud-31	Trace signal 3 Output Terminal selection	UINT	RW	PDO	0 ~ 93	1
0x3048	0x2D	Ud-32	Trace signal 4 Input/Output selection	UINT	RW	PDO	0 ~ 1	1
0x3048	0x2E	Ud-33	Trace signal 4 Input Terminal selection	UINT	RW	PDO	0 ~ 110	1
0x3048	0x2F	Ud-34	Trace signal 4 Output Terminal selection	UINT	RW	PDO	0 ~ 93	1
0x3048	0x30	Ud-35	Trace signal 5 Input/Output selection	UINT	RW	PDO	0 ~ 1	1
0x3048	0x31	Ud-36	Trace signal 5 Input Terminal selection	UINT	RW	PDO	0 ~ 110	1
0x3048	0x32	Ud-37	Trace signal 5 Output Terminal selection	UINT	RW	PDO	0 ~ 93	1
0x3048	0x33	Ud-38	Trace signal 6 Input/Output selection	UINT	RW	PDO	0 ~ 1	1
0x3048	0x34	Ud-39	Trace signal 6 Input Terminal selection	UINT	RW	PDO	0 ~ 110	1
0x3048	0x35	Ud-40	Trace signal 6 Output Terminal selection	UINT	RW	PDO	0 ~ 93	1
0x3048	0x36	Ud-41	Trace signal 7 Input/Output selection	UINT	RW	PDO	0 ~ 1	1
0x3048	0x37	Ud-42	Trace signal 7 Input Terminal selection	UINT	RW	PDO	0 ~ 110	1
0x3048	0x38	Ud-43	Trace signal 7 Output Terminal selection	UINT	RW	PDO	0 ~ 93	1
0x3048	0x3F	Ud-50	Trace trigger 1 selection	UINT	RW	PDO	0 ~ 16	1

Index	Sub-index	Func code	Function name	Type	Access	PDO	Setting Items	Data resolution -units
0x3048	0x40	Ud-51	Trigger 1 action selection at trace data trigger	UINT	RW	PDO	0 ~ 1	1
0x3048	0x41	Ud-52	Trigger 1 level setting at trace data trigger	UINT	RW	PDO	0 ~ 100	1%
0x3048	0x42	Ud-53	Trigger 1 action selection at trace signal trigger	UINT	RW	PDO	0 ~ 1	1
0x3048	0x43	Ud-54	Trace trigger 2 selection	UINT	RW	PDO	0 ~ 16	1
0x3048	0x44	Ud-55	Trigger 2 action selection at trace data trigger	UINT	RW	PDO	0 ~ 1	1
0x3048	0x45	Ud-56	Trigger 2 level setting at trace data trigger	UINT	RW	PDO	0 ~ 100	1%
0x3048	0x46	Ud-57	Trigger 2 action selection at trace signal trigger	UINT	RW	PDO	0 ~ 1	1
0x3048	0x47	Ud-58	Trigger condition selection	UINT	RW	PDO	0 ~ 3	1
0x3048	0x48	Ud-59	Trigger point setting	UINT	RW	PDO	0 ~ 100	1%
0x3048	0x49	Ud-60	Sampling time selection	UINT	RW	PDO	1 ~ 10	1
0x3048	0x72	UE-01	EzSQ operation cycle	UINT	RW	TxPDO	0 ~ 1	1
0x3048	0x73	UE-02	EzSQ function enable	UINT	RW	PDO	0 ~ 2	1
0x3048	0x7B	UE-10	EzSQ User parameter U(00)	UINT	RW	PDO	0 ~ 65535	1
0x3048	0x7C	UE-11	EzSQ User parameter U(01)	UINT	RW	PDO	0 ~ 65535	1
0x3048	0x7D	UE-12	EzSQ User parameter U(02)	UINT	RW	PDO	0 ~ 65535	1
0x3048	0x7E	UE-13	EzSQ User parameter U(03)	UINT	RW	PDO	0 ~ 65535	1
0x3048	0x7F	UE-14	EzSQ User parameter U(04)	UINT	RW	PDO	0 ~ 65535	1
0x3048	0x80	UE-15	EzSQ User parameter U(05)	UINT	RW	PDO	0 ~ 65535	1
0x3048	0x81	UE-16	EzSQ User parameter U(06)	UINT	RW	PDO	0 ~ 65535	1
0x3048	0x82	UE-17	EzSQ User parameter U(07)	UINT	RW	PDO	0 ~ 65535	1
0x3048	0x83	UE-18	EzSQ User parameter U(08)	UINT	RW	PDO	0 ~ 65535	1
0x3048	0x84	UE-19	EzSQ User parameter U(09)	UINT	RW	PDO	0 ~ 65535	1
0x3048	0x85	UE-20	EzSQ User parameter U(10)	UINT	RW	PDO	0 ~ 65535	1
0x3048	0x86	UE-21	EzSQ User parameter U(11)	UINT	RW	PDO	0 ~ 65535	1

Index	Sub-index	Func code	Function name	Type	Access	PDO	Setting Items	Data resolution -units
0x3048	0x87	UE-22	EzSQ User parameter U(12)	UINT	RW	PDO	0 ~ 65535	1
0x3048	0x88	UE-23	EzSQ User parameter U(13)	UINT	RW	PDO	0 ~ 65535	1
0x3048	0x89	UE-24	EzSQ User parameter U(14)	UINT	RW	PDO	0 ~ 65535	1
0x3048	0x8A	UE-25	EzSQ User parameter U(15)	UINT	RW	PDO	0 ~ 65535	1
0x3048	0x8B	UE-26	EzSQ User parameter U(16)	UINT	RW	PDO	0 ~ 65535	1
0x3048	0x8C	UE-27	EzSQ User parameter U(17)	UINT	RW	PDO	0 ~ 65535	1
0x3048	0x8D	UE-28	EzSQ User parameter U(18)	UINT	RW	PDO	0 ~ 65535	1
0x3048	0x8E	UE-29	EzSQ User parameter U(19)	UINT	RW	PDO	0 ~ 65535	1
0x3048	0x8F	UE-30	EzSQ User parameter U(20)	UINT	RW	PDO	0 ~ 65535	1
0x3048	0x90	UE-31	EzSQ User parameter U(21)	UINT	RW	PDO	0 ~ 65535	1
0x3048	0x91	UE-32	EzSQ User parameter U(22)	UINT	RW	PDO	0 ~ 65535	1
0x3048	0x92	UE-33	EzSQ User parameter U(23)	UINT	RW	PDO	0 ~ 65535	1
0x3048	0x93	UE-34	EzSQ User parameter U(24)	UINT	RW	PDO	0 ~ 65535	1
0x3048	0x94	UE-35	EzSQ User parameter U(25)	UINT	RW	PDO	0 ~ 65535	1
0x3048	0x95	UE-36	EzSQ User parameter U(26)	UINT	RW	PDO	0 ~ 65535	1
0x3048	0x96	UE-37	EzSQ User parameter U(27)	UINT	RW	PDO	0 ~ 65535	1
0x3048	0x97	UE-38	EzSQ User parameter U(28)	UINT	RW	PDO	0 ~ 65535	1
0x3048	0x98	UE-39	EzSQ User parameter U(29)	UINT	RW	PDO	0 ~ 65535	1
0x3048	0x99	UE-40	EzSQ User parameter U(30)	UINT	RW	PDO	0 ~ 65535	1
0x3048	0x9A	UE-41	EzSQ User parameter U(31)	UINT	RW	PDO	0 ~ 65535	1
0x3048	0x9B	UE-42	EzSQ User parameter U(32)	UINT	RW	PDO	0 ~ 65535	1
0x3048	0x9C	UE-43	EzSQ User parameter U(33)	UINT	RW	PDO	0 ~ 65535	1
0x3048	0x9D	UE-44	EzSQ User parameter U(34)	UINT	RW	PDO	0 ~ 65535	1
0x3048	0x9E	UE-45	EzSQ User parameter U(35)	UINT	RW	PDO	0 ~ 65535	1
0x3048	0x9F	UE-46	EzSQ User parameter U(36)	UINT	RW	PDO	0 ~ 65535	1
0x3048	0xA0	UE-47	EzSQ User parameter U(37)	UINT	RW	PDO	0 ~ 65535	1
0x3048	0xA1	UE-48	EzSQ User parameter U(38)	UINT	RW	PDO	0 ~ 65535	1
0x3048	0xA2	UE-49	EzSQ User parameter U(39)	UINT	RW	PDO	0 ~ 65535	1
0x3048	0xA3	UE-50	EzSQ User parameter U(40)	UINT	RW	PDO	0 ~ 65535	1

Index	Sub-index	Func code	Function name	Type	Access	PDO	Setting Items	Data resolution -units
0x3048	0xA4	UE-51	EzSQ User parameter U(41)	UINT	RW	PDO	0 ~ 65535	1
0x3048	0xA5	UE-52	EzSQ User parameter U(42)	UINT	RW	PDO	0 ~ 65535	1
0x3048	0xA6	UE-53	EzSQ User parameter U(43)	UINT	RW	PDO	0 ~ 65535	1
0x3048	0xA7	UE-54	EzSQ User parameter U(44)	UINT	RW	PDO	0 ~ 65535	1
0x3048	0xA8	UE-55	EzSQ User parameter U(45)	UINT	RW	PDO	0 ~ 65535	1
0x3048	0xA9	UE-56	EzSQ User parameter U(46)	UINT	RW	PDO	0 ~ 65535	1
0x3048	0xAA	UE-57	EzSQ User parameter U(47)	UINT	RW	PDO	0 ~ 65535	1
0x3048	0xAB	UE-58	EzSQ User parameter U(48)	UINT	RW	PDO	0 ~ 65535	1
0x3048	0xAC	UE-59	EzSQ User parameter U(49)	UINT	RW	PDO	0 ~ 65535	1
0x3048	0xAD	UE-60	EzSQ User parameter U(50)	UINT	RW	PDO	0 ~ 65535	1
0x3048	0xAE	UE-61	EzSQ User parameter U(51)	UINT	RW	PDO	0 ~ 65535	1
0x3048	0xAF	UE-62	EzSQ User parameter U(52)	UINT	RW	PDO	0 ~ 65535	1
0x3048	0xB0	UE-63	EzSQ User parameter U(53)	UINT	RW	PDO	0 ~ 65535	1
0x3048	0xB1	UE-64	EzSQ User parameter U(54)	UINT	RW	PDO	0 ~ 65535	1
0x3048	0xB2	UE-65	EzSQ User parameter U(55)	UINT	RW	PDO	0 ~ 65535	1
0x3048	0xB3	UE-66	EzSQ User parameter U(56)	UINT	RW	PDO	0 ~ 65535	1
0x3048	0xB4	UE-67	EzSQ User parameter U(57)	UINT	RW	PDO	0 ~ 65535	1
0x3048	0xB5	UE-68	EzSQ User parameter U(58)	UINT	RW	PDO	0 ~ 65535	1
0x3048	0xB6	UE-69	EzSQ User parameter U(59)	UINT	RW	PDO	0 ~ 65535	1
0x3048	0xB7	UE-70	EzSQ User parameter U(60)	UINT	RW	PDO	0 ~ 65535	1
0x3048	0xB8	UE-71	EzSQ User parameter U(61)	UINT	RW	PDO	0 ~ 65535	1
0x3048	0xB9	UE-72	EzSQ User parameter U(62)	UINT	RW	PDO	0 ~ 65535	1
0x3048	0xBA	UE-73	EzSQ User parameter U(63)	UINT	RW	PDO	0 ~ 65535	1
0x4048	0xD7	UF-02	EzSQ User parameter UL(00)	DINT	RW	PDO	-2147483647 ~ 2147483647	1
0x4048	0xD9	UF-04	EzSQ User parameter UL(01)	DINT	RW	PDO	-2147483647 ~ 2147483647	1
0x4048	0xDB	UF-06	EzSQ User parameter UL(02)	DINT	RW	PDO	-2147483647 ~ 2147483647	1
0x4048	0xDD	UF-08	EzSQ User parameter UL(03)	DINT	RW	PDO	-2147483647 ~ 2147483647	1
0x4048	0xDF	UF-10	EzSQ User parameter UL(04)	DINT	RW	PDO	-2147483647 ~ 2147483647	1
0x4048	0xE1	UF-12	EzSQ User parameter UL(05)	DINT	RW	PDO	-2147483647 ~ 2147483647	1

Index	Sub-index	Func code	Function name	Type	Access	PDO	Setting Items	Data resolution ·units
0x4048	0xE3	UF-14	EzSQ User parameter UL (06)	DINT	RW	PDO	-2147483647 ~ 2147483647	1
0x4048	0xE5	UF-16	EzSQ User parameter UL (07)	DINT	RW	PDO	-2147483647 ~ 2147483647	1
0x4048	0xE7	UF-18	EzSQ User parameter UL (08)	DINT	RW	PDO	-2147483647 ~ 2147483647	1
0x4048	0xE9	UF-20	EzSQ User parameter UL (09)	DINT	RW	PDO	-2147483647 ~ 2147483647	1
0x4048	0xEB	UF-22	EzSQ User parameter UL (10)	DINT	RW	PDO	-2147483647 ~ 2147483647	1
0x4048	0xED	UF-24	EzSQ User parameter UL (11)	DINT	RW	PDO	-2147483647 ~ 2147483647	1
0x4048	0xEF	UF-26	EzSQ User parameter UL (12)	DINT	RW	PDO	-2147483647 ~ 2147483647	1
0x4048	0xF1	UF-28	EzSQ User parameter UL (13)	DINT	RW	PDO	-2147483647 ~ 2147483647	1
0x4048	0xF3	UF-30	EzSQ User parameter UL (14)	DINT	RW	PDO	-2147483647 ~ 2147483647	1
0x4048	0xF5	UF-32	EzSQ User parameter UL (15)	DINT	RW	PDO	-2147483647 ~ 2147483647	1

13.2.10 Others

Index	Sub-index	Func code	Function name	Type	Access	PDO	Setting Items	Data resolution ·units
0x3023	0x6F	0	EEPROM Write	UINT	W	Not possible	01 : Write all parameters	1
0x3023	0x71	0	EEPROM Write Mode Selection	UINT	W	Not possible	01 : enabled	1
0x3023	0x79	0	Motor Constant Recomputation	UINT	W	Not possible	01 : enabled	1

(Memo)