

## User Manual – PWM & Pulse Output Modules

**EH-RIO2 Series**

**PWM: RIO2-PWM2**

**Pulse: RIO2-PO2**

**Version 1.04**

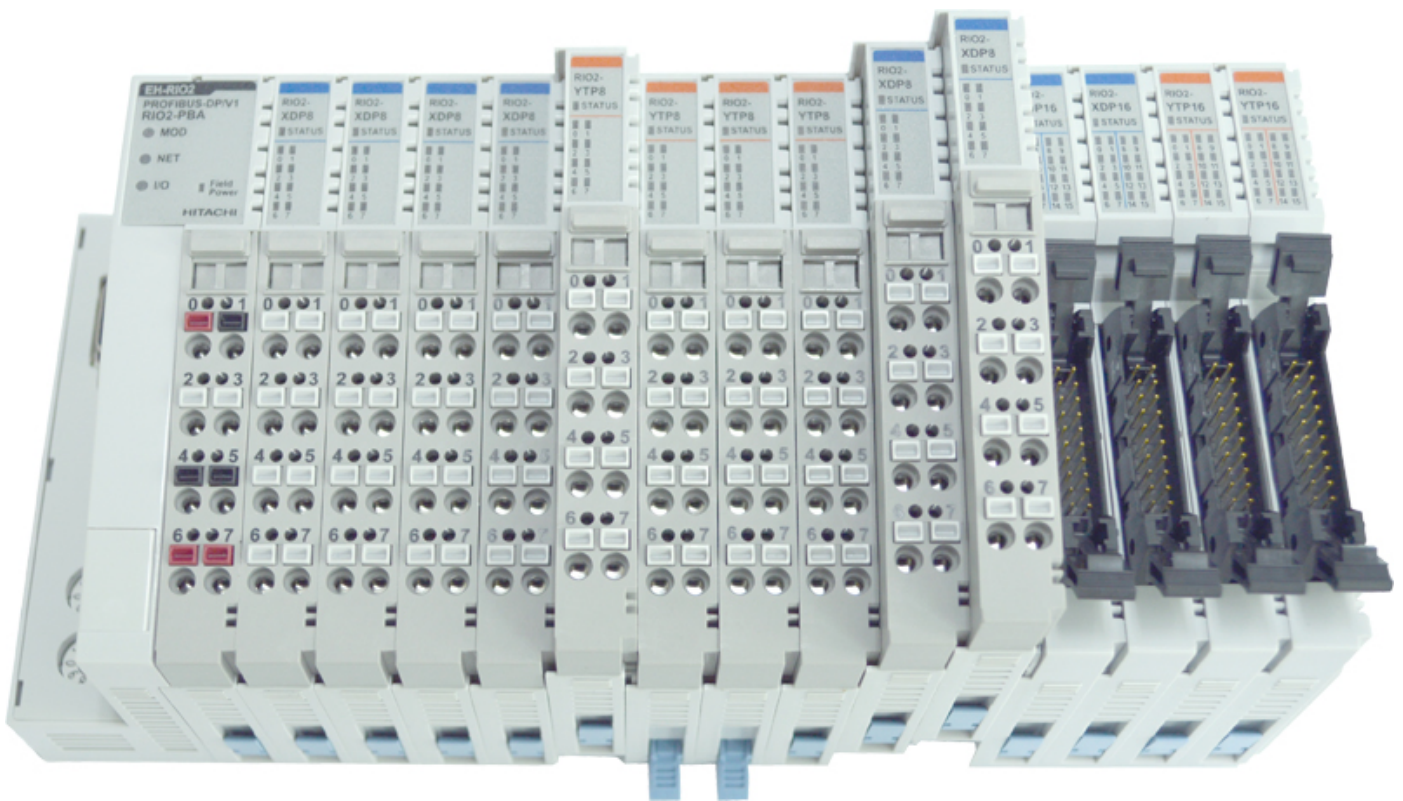

## User Manual – PWM & Pulse Output Modules

DOCUMENT CHANGE SUMMARY				
REV	PAGE	REMARKS	DATE	EDITOR
1.04	New	Created	23.06.2015	Winter

# User Manual – PWM & Pulse Output Modules

## Table of Contents

1. Important Notes .....	1
1.1 Safety Instruction.....	1
1.1.1 Symbols .....	1
1.1.2 Safety Notes .....	1
1.1.3 Certification.....	1
2. MODULE LIST .....	2
2.1 PWM OUTPUT MODULE LIST .....	2
2.2 PULSE OUTPUT MODULE LIST .....	2
3. SPECIFICATION.....	3
3.1 THE INTERFACE .....	3
3.1.1 PWM OUTPUT MODULE .....	3
3.1.1.1 RIO2-PWM2.....	3
3.1.2 PULSE OUTPUT MODULE .....	4
3.1.2.1 RIO2-PO2 .....	4
3.2 ENVIRONMENT SPECIFICATION .....	5
3.3 SPECIFICATION .....	6
3.3.1 PWM MODULE .....	6
3.3.1.1 RIO2-PWM2.....	6
3.3.2 PULSE MODULE .....	7
3.3.2.1 RIO2-PO2 .....	7
4. DIMENSIONS .....	8
4.1 RIO2-PWM2.....	8
4.2 RIO2-PO2 .....	8

## **User Manual – PWM & Pulse Output Modules**

5. CONFIGURATION AND OPERATIONAL FUNCTION .....	9
5.1 PWM OUTPUT MODULE .....	9
5.1.1 RIO2-PWM2 (2 CH PWM OUTPUT, 0.5A/24VDC, SOURCE) .....	9
5.1.1.1 Input Image Data - 2byte .....	9
5.1.1.2 Output Image Data - 6byte .....	9
5.1.1.3 Configuration Parameter Data .....	9
5.2 PULSE OUTPUT MODULE .....	11
5.2.1 RIO2-PO2 (2 CH PWM OUTPUT, 0.5A/24VDC, SOURCE) .....	11
5.2.1.1 Input Image Data - 8byte .....	11
5.2.1.2 Output Image Data - 10byte .....	11
5.2.1.3 Configuration Parameter Data .....	11
6. Trouble Shooting .....	12

# User Manual – PWM & Pulse Output Modules

## 1. Important Notes

Solid state equipment has operational characteristics differing from those of electromechanical equipment.

Safety Guidelines for the Application, Installation and Maintenance of Solid State Controls describes some important differences between solid state equipment and hard-wired electromechanical devices.

Because of this difference, and also because of the wide variety of uses for solid state equipment, all persons responsible for applying this equipment must satisfy themselves that each intended application of this equipment is acceptable.

In no event will Hitachi be responsible or liable for indirect or consequential damages resulting from the use or application of this equipment.

The examples and diagrams in this manual are included solely for illustrative purposes. Because of the many variables and requirements associated with any particular installation, Hitachi cannot assume responsibility or liability for actual use based on the examples and diagrams.

### Warning!

- ✓ **If you don't follow the directions, it could cause a personal injury, damage to the equipment or explosion**
- Do not assemble the products and wire with power applied to the system. Else it may cause an electric arc, which can result into unexpected and potentially dangerous action by field devices. Arching is explosion risk in hazardous locations. Be sure that the area is non-hazardous or remove system power appropriately before assembling or wiring the modules.
- Do not touch any terminal blocks or IO modules when system is running. Else it may cause the unit to an electric shock or malfunction.
- Keep away from the strange metallic materials not related to the unit and wiring works should be controlled by the electric expert engineer. Else it may cause the unit to a fire, electric shock or malfunction.



### Caution!

- ✓ **If you disobey the instructions, there may be possibility of personal injury, damage to equipment or explosion. Please follow below Instructions.**
- Check the rated voltage and terminal array before wiring. Avoid the circumstances over 55°C of temperature. Avoid placing it directly in the sunlight.
- Avoid the place under circumstances over 85% of humidity.
- Do not place Modules near by the inflammable material. Else it may cause a fire.
- Do not permit any vibration approaching it directly.
- Go through module specification carefully, ensure inputs, output connections are made with the specifications. Use standard cables for wiring.
- Use Product under pollution degree 2 environment.

# User Manual – PWM & Pulse Output Modules

## 1.1 Safety Instruction

### 1.1.1 Symbols

<p><b>DANGER</b></p> 	<p>Identifies information about practices or circumstances that can cause an explosion in a hazardous environment, which may lead to personal injury or death property damage, or economic loss.</p>
<p><b>IMPORTANT</b></p>	<p>Identifies information that is critical for successful application and understanding of the product</p>
<p><b>ATTENTION</b></p> 	<p>Identifies information about practices or circumstances that can lead to personal injury, property damage, or economic loss.</p> <p>Attentions help you to identify a hazard, avoid a hazard, and recognize the consequences</p>

### 1.1.2 Safety Notes

<p><b>DANGER</b></p> 	<p>The modules are equipped with electronic components that may be destroyed by electrostatic discharge. When handling the modules, ensure that the environment (persons, workplace and packing) is well grounded.</p> <p>Avoid touching conductive components, e.g. FnBUS Pin.</p>
--	---

### 1.1.3 Certification

CE Certificate

EN 61000-6-2; Industrial Immunity

EN 61000-6-4; Industrial Emissions

## User Manual – PWM & Pulse Output Modules

### 2. MODULE LIST

#### 2.1 PWM OUTPUT MODULE LIST

Number	Description	ID(hex)	Production status
RIO2-PWM2	2 CH PWM OUTPUT, 0.5A/24VDC, SOURCE	56	Active

#### 2.2 PULSE OUTPUT MODULE LIST

Number	Description	ID(hex)	Production status
RIO2-PO2	2 CH Pulse OUTPUT, 0.5A/24VDC, SOURCE	90	Active

## User Manual – PWM & Pulse Output Modules

### 3. SPECIFICATION

#### 3.1 THE INTERFACE

##### 3.1.1 PWM OUTPUT MODULE

##### 3.1.1.1 RIO2-PWM2

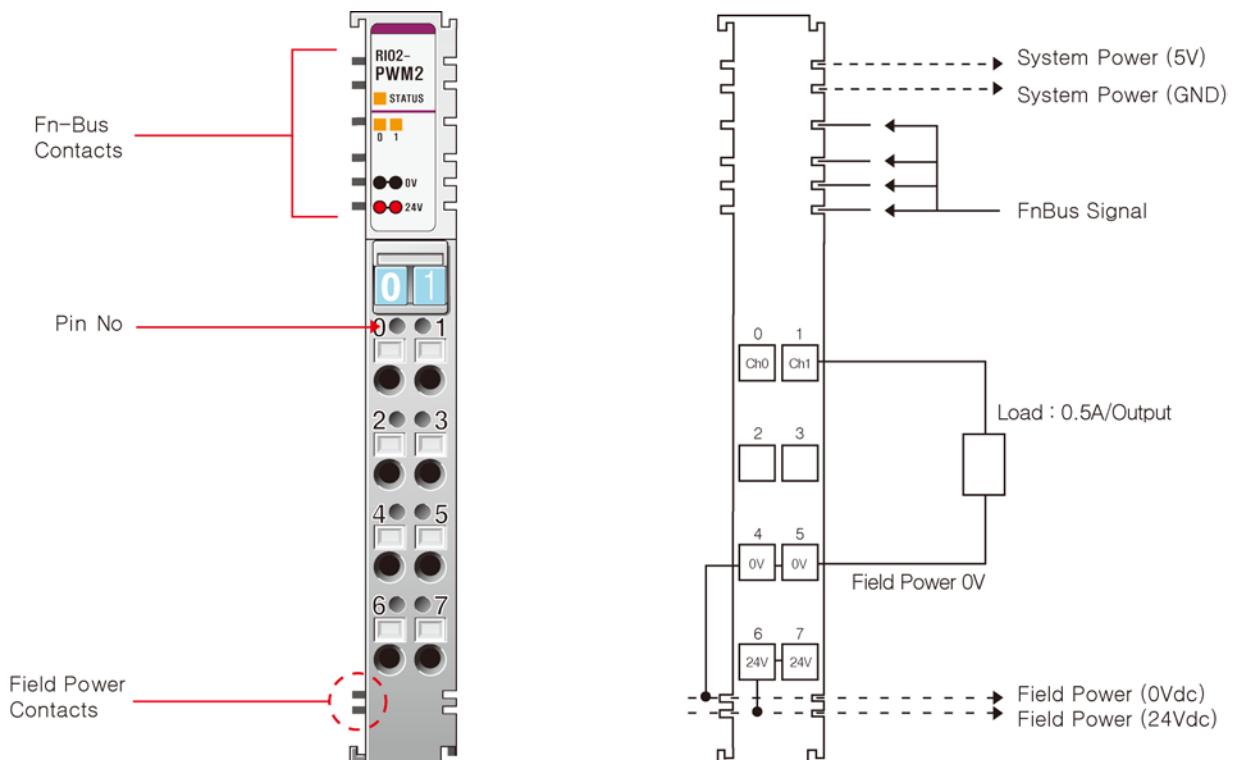

Pin No.	Description	Pin No.	Description
0	PWM Output Channel #0	1	PWM Output Channel #1
2	---	3	---
4	Field Power 0V, Common	5	Field Power 0V, Common
6	Field Power 24V	7	Field Power 24V



## User Manual – PWM & Pulse Output Modules

### 3.1.2 PULSE OUTPUT MODULE

#### 3.1.2.1 RIO2-PO2

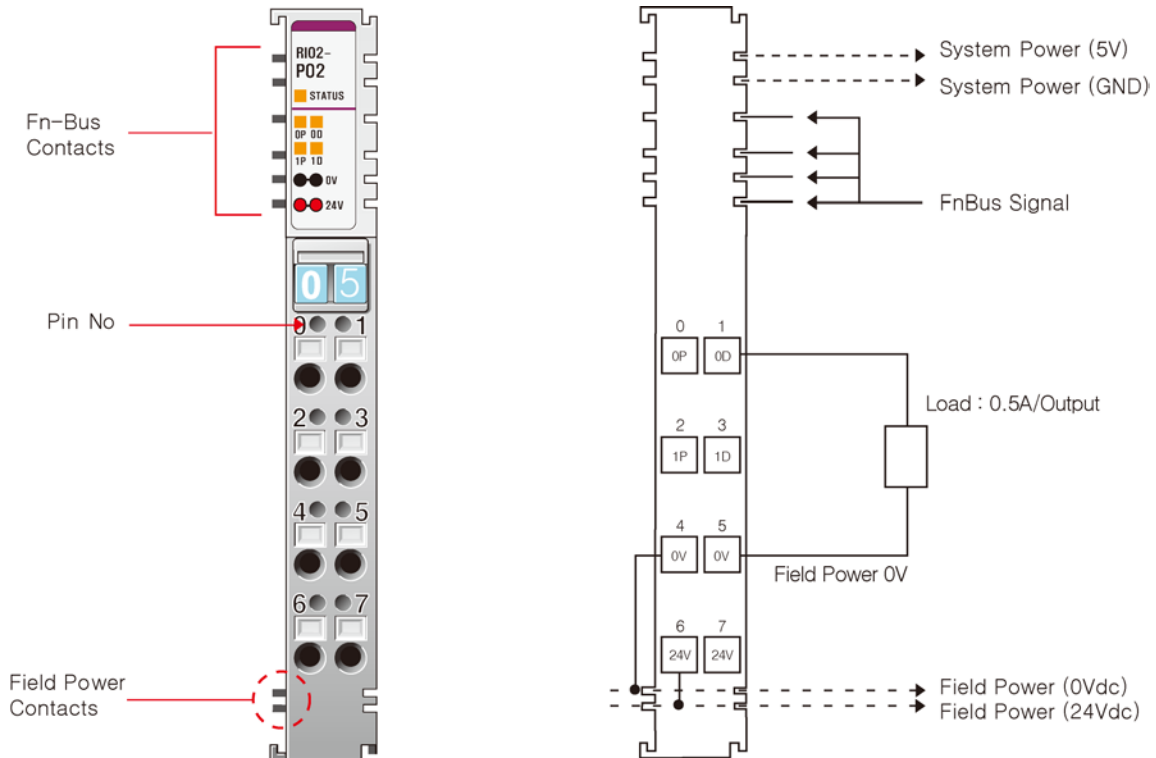

Pin No.	Description	Pin No.	Description
0	Pulse Output Channel #0	1	Pulse Direction Output Channel #0
2	Pulse Output Channel #1	3	Pulse Direction Output Channel #1
4	Field Power 0V, Common	5	Field Power 0V, Common
6	Field Power 24V	7	Field Power 24V

## User Manual – PWM & Pulse Output Modules

### 3.2 ENVIRONMENT SPECIFICATION

<b>Environmental Specifications</b>	
Operating Temperature	-20°C~55°C
Storage Temperature	-40°C~85°C
Relative Humidity	5% ~ 90% non-condensing
Operating Altitude	2000m
Mounting	DIN rail
<b>General Specifications</b>	
Shock Operating	10g
Shock Non-Operating	30g
Vibration/Shock resistance	Displacement : 0.012Inch p-p from 10~57Hz Acceleration : 2G's from 57~500Hz Sweep Rate : 1 octave Per Minute Axes to test : x, y, z Frequency Sweeps Per Axis : 10
EMC resistance burst/ESD	EMC Directive
Installation Pos. / Protect. Class	Variable/IP20
Product Certifications	CE

## User Manual – PWM & Pulse Output Modules

### 3.3 SPECIFICATION

#### 3.3.1 PWM MODULE

##### 3.3.1.1 RIO2-PWM2

Items	Specification
<b>Output Specification</b>	
Number of Outputs	2 Channel, Source Type
Indicators	1 Green/Red FnBus Status 2 Channel LEDs
Output Current	0.5A/Ch, 2A/All Channel, short protection.
Output Inrush Current	Max. 1.5A, 100ms / Ch
PWM Frequency	1~2500Hz±0.5%
PWM Duty	0.0~100.0%±1.0% (0.1%/1LSB), Ton>5us, Toff>5us
Diagnostic	Short Protection
Common Type	2Common
<b>General Specification</b>	
Power Dissipation	Max. 150mA @5.0Vdc
Isolation	I/O to Logic : Photocoupler Isolation I/O to Field Power : Non-Isolation
Field Power	Supply Voltage : 24Vdc nominal Voltage Range : 18~28.8Vdc Power Dissipation: Max. 50mA @24Vdc except Load
Wiring	I/O Cable Max. 2.0mm <sup>2</sup> (AWG#14)
Weight	70g
Module Size	12mm x 99mm x 70mm
Environment Condition	Refer to Environment Specification.(p5)

## User Manual – PWM & Pulse Output Modules

### 3.3.2 PULSE MODULE

#### 3.3.2.1 RIO2-PO2

Items	Specification
<b>Output Specification</b>	
Number of Channel	2 Channel, Source Type
Number of Output	2 Output/Channel 4 Output (2 Pulse Output, 2 Pulse Direction Output)
Indicators	1 Green/Red FnBus Status 2 Pulse Output LED, 2 Pulse Direction Output LED
Output Current	0.5A/Output, 2A/All Output, short protection
Pulse Output Frequency	1~20,000Hz±0.5%
Pulse Output Duty	50%±3.0% Fixed, Ton>5us, Toff>5us
Pulse Output Quantity with One Command	Continuous Pulse Output Max. +1~32767 : Pulse Direction Output OFF Max. -1~32767 : Pulse Direction Output ON
Pulse Output Counter	Signed 32bit-wide
Diagnostic	Yes, Short Protection
Common Type	2Common
<b>General Specification</b>	
Power Dissipation	Max. 150mA @5.0Vdc
Isolation	I/O to Logic : Photocoupler Isolation I/O to Field Power : Non-Isolation
Field Power	Supply Voltage : 24Vdc nominal Voltage Range : 18~28.8Vdc Power Dissipation: Max. 60mA @24Vdc except Load
Wiring	I/O Cable Max. 2.0mm <sup>2</sup> (AWG#14)
Weight	70g
Module Size	12mm x 99mm x 70mm
Environment Condition	Refer to Environment Specification.(p5)

## User Manual – PWM & Pulse Output Modules

### 4. DIMENSIONS

#### 4.1 RIO2-PWM2

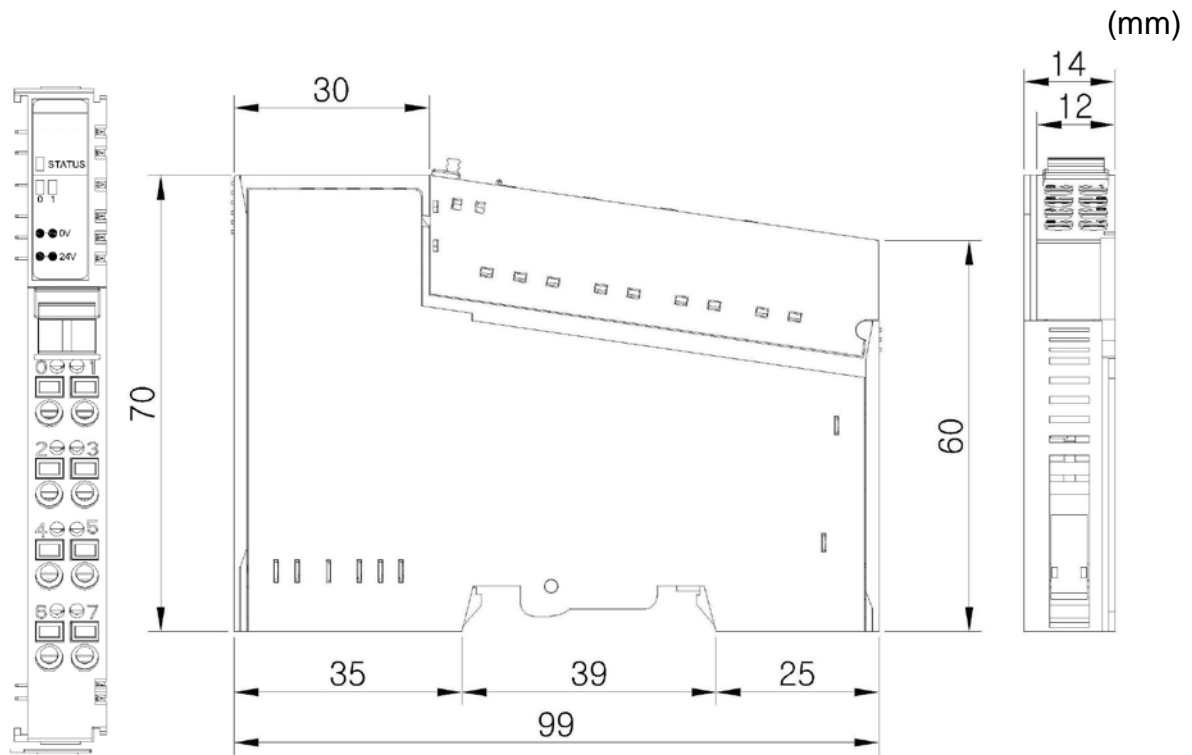

#### 4.2 RIO2-PO2

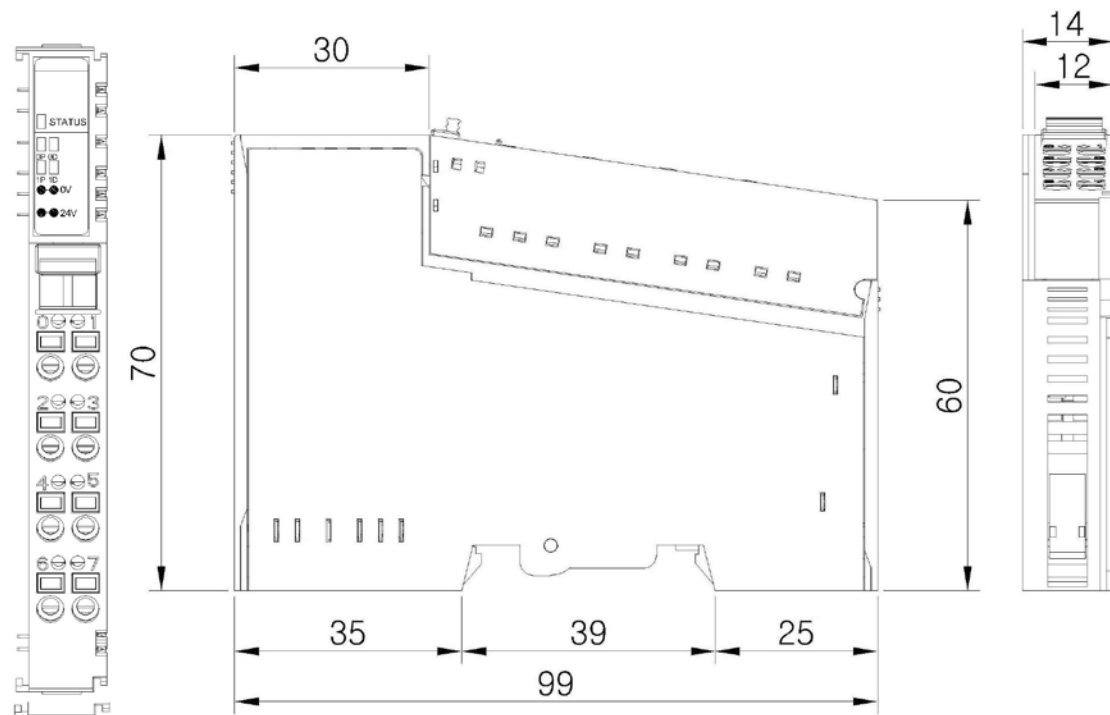

## User Manual – PWM & Pulse Output Modules

### 5. CONFIGURATION AND OPERATIONAL FUNCTION

#### 5.1 PWM OUTPUT MODULE

##### 5.1.1 RIO2-PWM2 (2 CH PWM OUTPUT, 0.5A/24VDC, SOURCE)

###### 5.1.1.1 Input Image Data - 2byte

Byte	Bit 7	Bit 6	Bit 5	Bit 4	Bit 3	Bit 2	Bit 1	Bit 0
0	Reserved							
1	Reserved							

###### 5.1.1.2 Output Image Data - 6byte

Byte	Bit 7	Bit 6	Bit 5	Bit 4	Bit 3	Bit 2	Bit 1	Bit 0
0	Frequency Ch#0,1 Low Byte							
1	Frequency Ch#0,1 High Byte							
2	Duty Ch#0 Low Byte							
3	Duty Ch#0 High Byte							
4	Duty Ch#1 Low Byte							
5	Duty Ch#1 High Byte							

- Ch#0, 1 is using the same frequency.
- Range of each Duty is 0(0.0%) ~ 1000(100.0%). If Duty value is 250, then Duty rate is 25.0%

###### 5.1.1.3 Configuration Parameter Data

Byte	Bit 7	Bit 6	Bit 5	Bit 4	Bit 3	Bit 2	Bit 1	Bit 0
0	Reserved							
1	Reserved							

## User Manual – PWM & Pulse Output Modules

### \*Compared Duty Rate

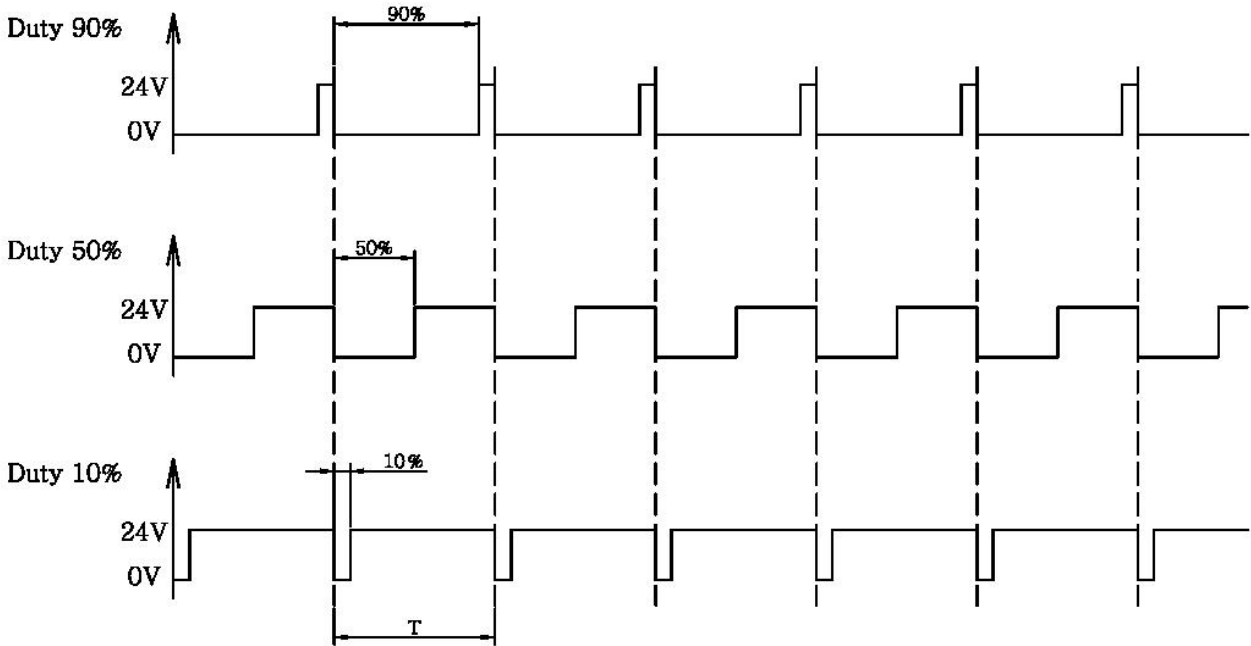

T = Time (If Frequency = 10 KHz then T= 0.1ms)

### \* When Frequency 1KHz and Duty 50%

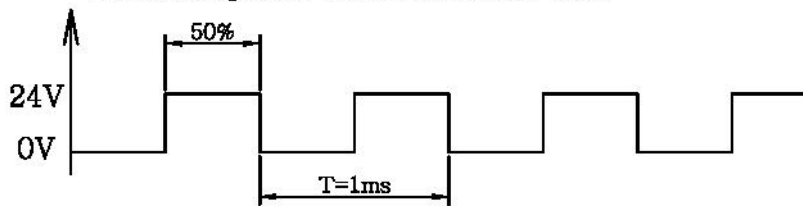

### \* When Frequency 2KHz and Duty 50%

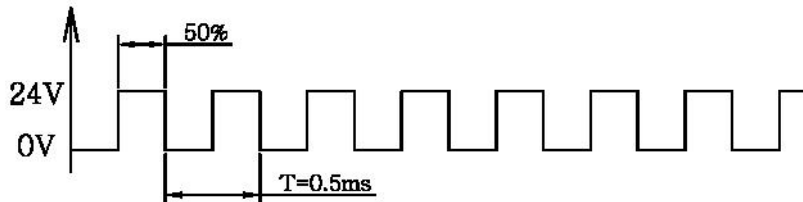

## User Manual – PWM & Pulse Output Modules

### 5.2 PULSE OUTPUT MODULE

#### 5.2.1 RIO2-PO2 (2 CH PWM OUTPUT, 0.5A/24VDC, SOURCE)

##### 5.2.1.1 Input Image Data - 8byte

Byte	Bit 7	Bit 6	Bit 5	Bit 4	Bit 3	Bit 2	Bit 1	Bit 0
0	Real Pulse Output Counter Ch#0 LL							
1	Real Pulse Output Counter Ch#0 LH							
2	Real Pulse Output Counter Ch#0 HL							
3	Real Pulse Output Counter Ch#0 HH							
4	Real Pulse Output Counter Ch#1 LL							
5	Real Pulse Output Counter Ch#1 LH							
6	Real Pulse Output Counter Ch#1 HL							
7	Real Pulse Output Counter Ch#1 HH							

- A Pulse Output Counter is a signed 32bit-wide data.

##### 5.2.1.2 Output Image Data - 10byte

Byte	Bit 7	Bit 6	Bit 5	Bit 4	Bit 3	Bit 2	Bit 1	Bit 0
0	Pulse Frequency Ch#0 Low Byte							
1	Pulse Frequency Ch#0 High Byte							
2	Pulse Output Qty Ch#0 Low Byte							
3	Pulse Output Qty Ch#0 High Byte							
4	Pulse Frequency Ch#1 Low Byte							
5	Pulse Frequency Ch#1 High Byte							
6	Pulse Output Qty Ch#1 Low Byte							
7	Pulse Output Qty Ch#1 High Byte							
8	RUN0	ECP0	----	CLRCNT 0	----	----	----	Frequency Multiple0
9	RUN1	ECP1	----	CLRCNT 1	----	----	----	Frequency Multiple1

- Pulse Output Qty is a signed 16bit-wide data.
- The duty of each channel frequency is fixed by 50%.
- If Pulse Output Qty $\geq$ 0, Direction Output turns OFF. If Pulse Output Qty < 0, Direction Output turns ON.
- Byte 8 is a control for Channel #0; Byte 9 is a control for Channel #1.
- RUN0,1 : Pulse Output Run
- ECP0, 1(Enable Continuous Pulse): If this bit is '1' and Pulse Output Qty is not 0, pulse output always runs.
- CLRCNT0,1 : Clear Real Pulse Output Counter

##### Frequency Multiple 0 Selection

Value	Description
0 (B'00)	x1 Frequency Multiple
1 (B'01)	x10 Frequency Multiple
2 (B'10)	x100 Frequency Multiple
3 (B'11)	x1000 Frequency Multiple

- If Pulse Frequency=123 and Frequency Multiple=2, real pulse output is 12.3KHz (123\*100)

##### 5.2.1.3 Configuration Parameter Data

Byte	Bit 7	Bit 6	Bit 5	Bit 4	Bit 3	Bit 2	Bit 1	Bit 0
0	Reserved							
1	Reserved							



## User Manual – PWM & Pulse Output Modules

### 6. Trouble Shooting

**ATTENTION**



In this manual, it couldn't be described all variety case with Network Adapter of several protocols. So if you couldn't find any fault after investigating all below cases, refer to EH-RIO2 user manual.

LED Status	Cause	Action
All LED turns off	- No power	- Check main power Cable
	- System power is not supplied.	- Contact Sales team and send module for repair.
STATUS LED flashes red	<ul style="list-style-type: none"> <li>- Excess of expansion slot</li> <li>- Excess of IO size</li> <li>- Wrong IO composition</li> <li>- Occurrence of EEPROM checksum error</li> </ul>	<ul style="list-style-type: none"> <li>- Use expansion slot up to 32.</li> <li>- Compose that IO total size is not excess.</li> <li>- Check composition I/O Module</li> </ul>

**Hitachi Europe GmbH**

Am Seestern 18  
D-40547 Düsseldorf, Germany

Tel: +49 (0) 211 52 83-0  
Fax: +49 (0) 211 52 83-649

**HITACHI**  
**Inspire the Next**